



Westinghouse Electric Corporation
Switchgear Division
East Pittsburgh, PA 15112, U.S.A.

Descriptive Bulletin
32-254

Page 1

July 1982
New Information
Mailed to: E, D, C/1942/DB

Up to 1000 MVA (37 KA) At 15000 Volts
Up to 350 MVA (41 KA) At 4760 Volts
1200 to 3000 Amperes
Indoor and Outdoor

VAC-CLAD Metal-Clad Switchgear

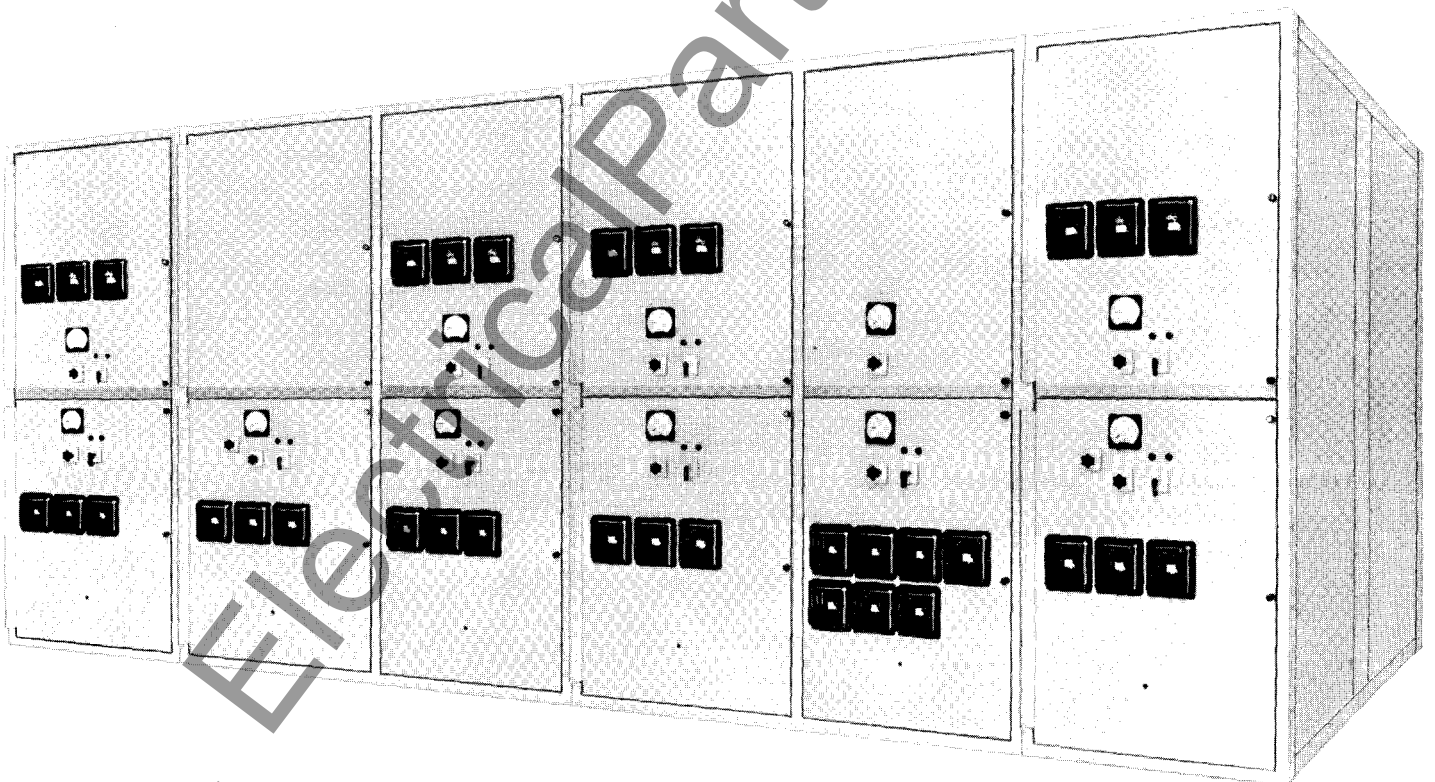

Application

Westinghouse VAC-CLAD Switchgear provides centralized control and protection of medium-voltage power equipment and circuits in industrial, commercial, and utility installations involving generators, motors, feeder circuits, and transmission and distribution lines.

VAC-CLAD Switchgear is available in voltage ratings from 4.76 Kv through 15 Kv and in nominal interrupting capacities from 250 (29 KA) through 1,000 MVA (37 KA). It is available for indoor and outdoor installation.

VAC-CLAD Switchgear meets the applicable industry standards for metal-clad switchgear - ANSI, NEMA and IEEE.

Systems Description

VAC-CLAD Metal-Clad Switchgear consists of two-high circuit-breaker, cable, and auxiliary compartments. These metal-enclosed compartments are assembled in various combinations to satisfy application requirements. Two-high arrangements are standard, but one-high arrangements can be supplied when a situation so requires.

VAC-CLAD Switchgear is designed to meet power-system needs in these six important areas:

1. Performance
2. Safety
3. Maintenance
4. Space utilization
5. Application flexibility
6. Reliability

The following photos show a typical VAC-CLAD assembly and identify the major parts, components and features related to control and protection requirements in the six important areas listed above.

1 Hinged Front Door

Door provides space for mounting of relays, meters, and instruments in a standardized arrangement. (See Application Flexibility, Page 19)

2 Screw-Type Levering Device

The levering system is a unique cell mounted design that, in one assembly, incorporates levering and safety interlocks. (See Performance, Page 7 and Safety, Page 14)

3 Horizontal Drawout Circuit Breaker

Type VCP unit breaker is a horizontal drawout design, which provides connect, test, and disconnect positions with the door closed. Cell mounted rail extensions allow complete withdrawal without requiring an auxiliary lifting device. (See Maintenance, Page 16)

4 Interphase Barrier

Barrier is cell mounted, providing additional safety and simplified breaker maintenance. (See Performance, Page 6)

5 Automatic Shutter

This steel shutter operates automatically, when the circuit breaker is withdrawn, to protect workmen from accidental contact with the stationary primary contacts. (See Safety, Page 14)

6 Frame and Housing

Unitized steel frames provide for maximum rigidity and flexibility for future modification. (See Application Flexibility, Page 19)

7 Main Bus and Supports

The main bus is fluidized bed epoxy insulation with the bus supports being porcelain at 15 Kv and glass polyester at 5 Kv. (See Performance, Page 8)

8 Ring-Type Current Transformers

Easily accessible from the front with space for a maximum of four current transformers per phase. (See Maintenance, Page 15 and Application Flexibility, Page 19)

9 Primary Stationary Contacts and Supports

Porcelain supports are provided on 15 Kv ratings and glass polyester supports on 5 Kv. (See Performance, Page 7)

10 Metal Compartment Barriers

All compartments are enclosed by grounded metal barriers. (See Safety, Page 14)

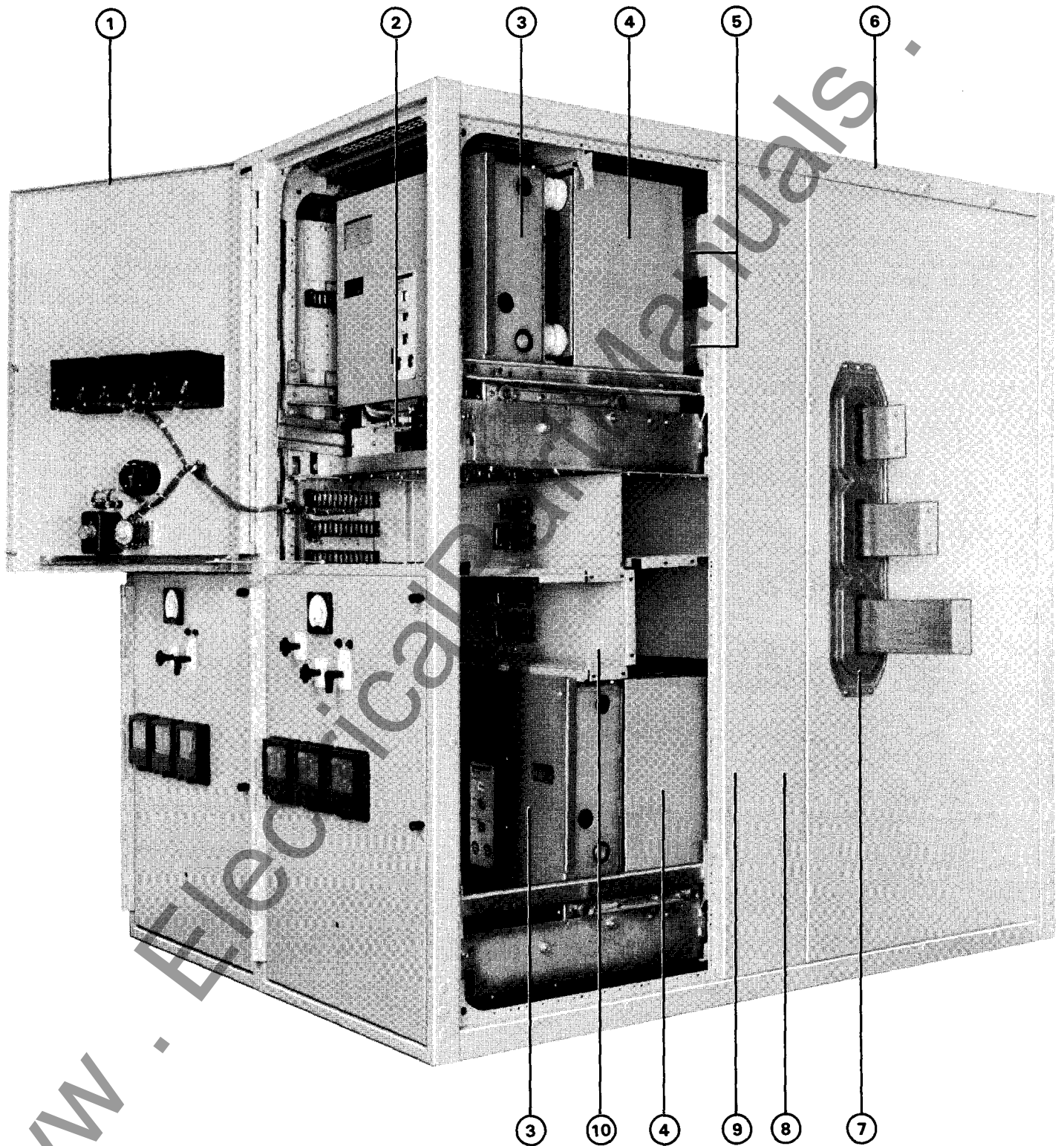

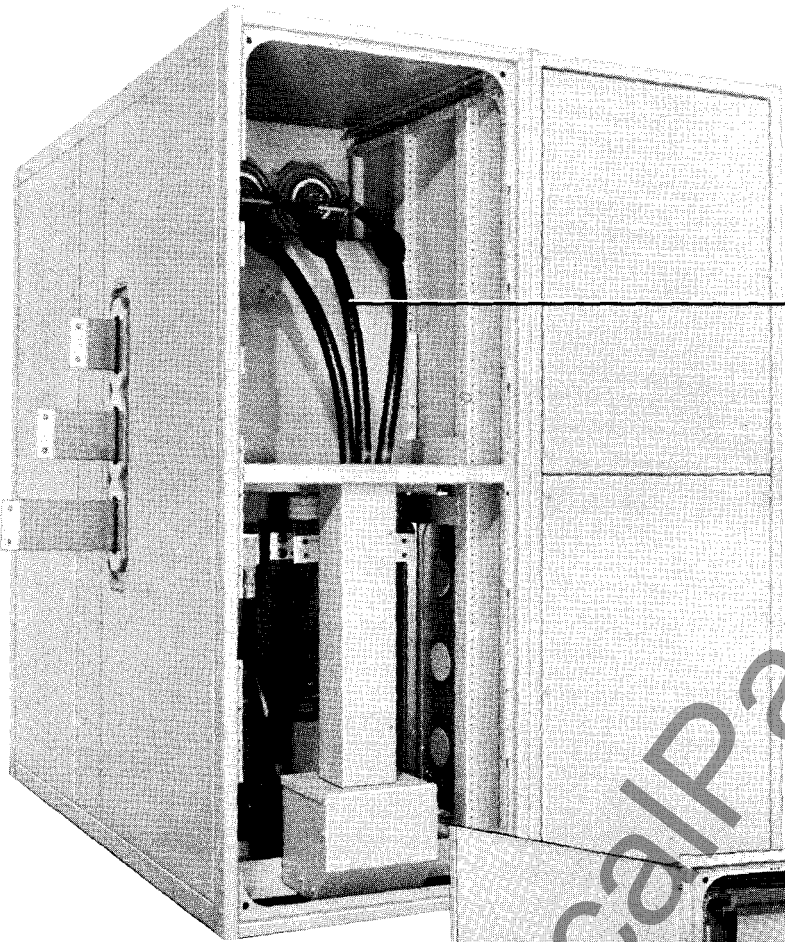

11 Cable Space
Ample space is provided for cables, potheads, and other related components. Top or bottom cable entry is available. (See Space Utilization, Page 18, Application Flexibility, Page 19, and Maintenance, Page 15)

12 Potential Transformers
Potential transformers are drawer mounted for front accessibility and can be completely withdrawn on cell mounted rail extensions units similar to the breaker. (See Maintenance, Page 15 and Performance Page 9)

13 Control Power Transformers
Drawer mounting makes control power transformers accessible, they can be completely withdrawn the same as the potential transformer. (See Maintenance, Page 15 and Performance, Page 9)

12

13



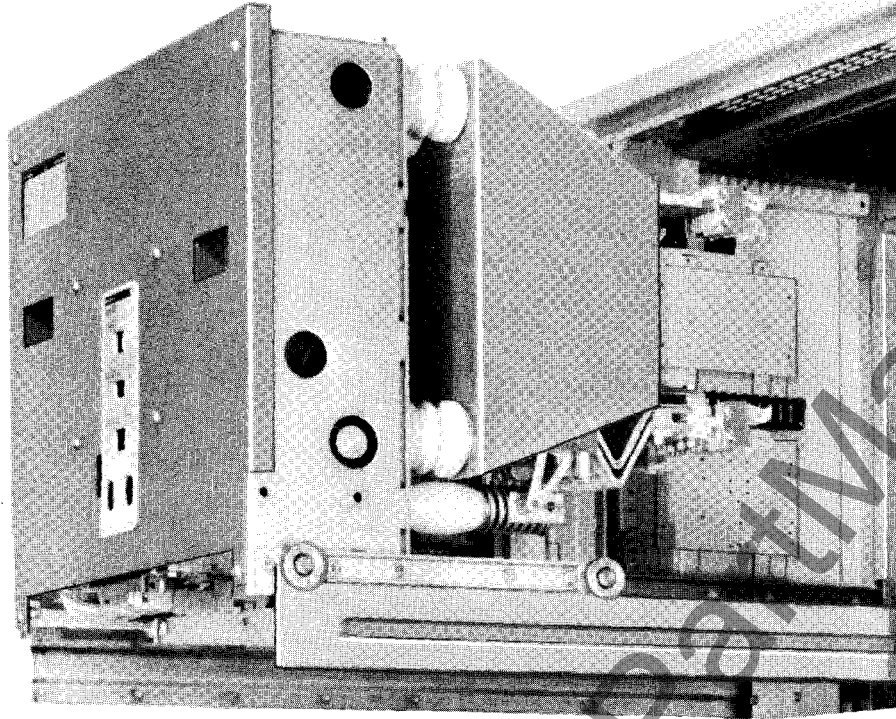

Type VCP circuit breaker utilizing vacuum interrupters is available in all ANSI ratings, plus several special ratings to provide maximum application flexibility. These breakers feature reduced size and light weight (650 lbs. Max).

Performance

VAC-CLAD Metal-Clad Switchgear offers a total design concept of cell, breaker and auxiliary equipment to meet the user needs. The design criteria was full compliance with ANSI, IEEE, and NEMA standards. Conformance to industry standards assures a high level of performance and permits the specifier with ease and accuracy to define a level of performance developed by the industry for its needs.

The applicable industry standards are:

- | | |
|---------|--|
| ANSI | American National Standards Institute |
| C37.010 | Application guide for ac high voltage circuit breakers rated on a symmetrical current basis |
| C37.100 | Definitions for power switchgear |
| C37.04 | Rating structure for ac high voltage circuit breakers |
| C37.06 | Preferred ratings for ac high voltage circuit breakers as rated on a symmetrical current basis |
| C37.07 | Factors for reclosing service |
| C37.09 | Test Procedure for ac high voltage circuit breakers |
| C37.11 | Power circuit breaker control |
| C37.20 | Switchgear assemblies including metal-enclosed bus |
| C37.24 | Guide for evaluating the effect of solar radiation |
| NEMA | National Electrical Manufacturers Association |
| SG-4 | Power Circuit Breakers |
| SG-5 | Power Switchgear Assemblies |

Performance

Cell Features

Breaker Compartment

Interphase barrier is cell mounted. As an additional safety feature, a definite action is required to remove the interphase barrier. Interlocks prevent breaker insertion, unless interphase barrier is in place.

The photo shows the breaker compartment with breaker removed and illustrating the cell mounted interphase barriers.

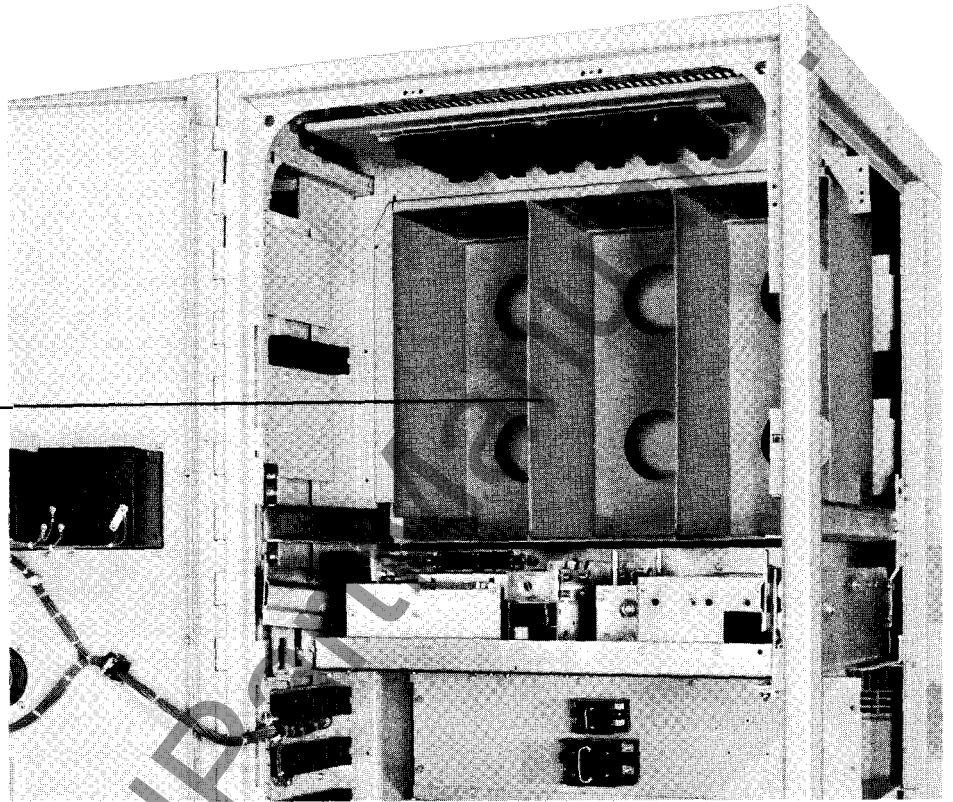

#11 gauge steel shutters prevent accidental contact with primary voltage live parts, when the breaker is withdrawn.

The photo shows the breaker compartment with interphase barriers removed exposing the #11 gauge steel shutters.

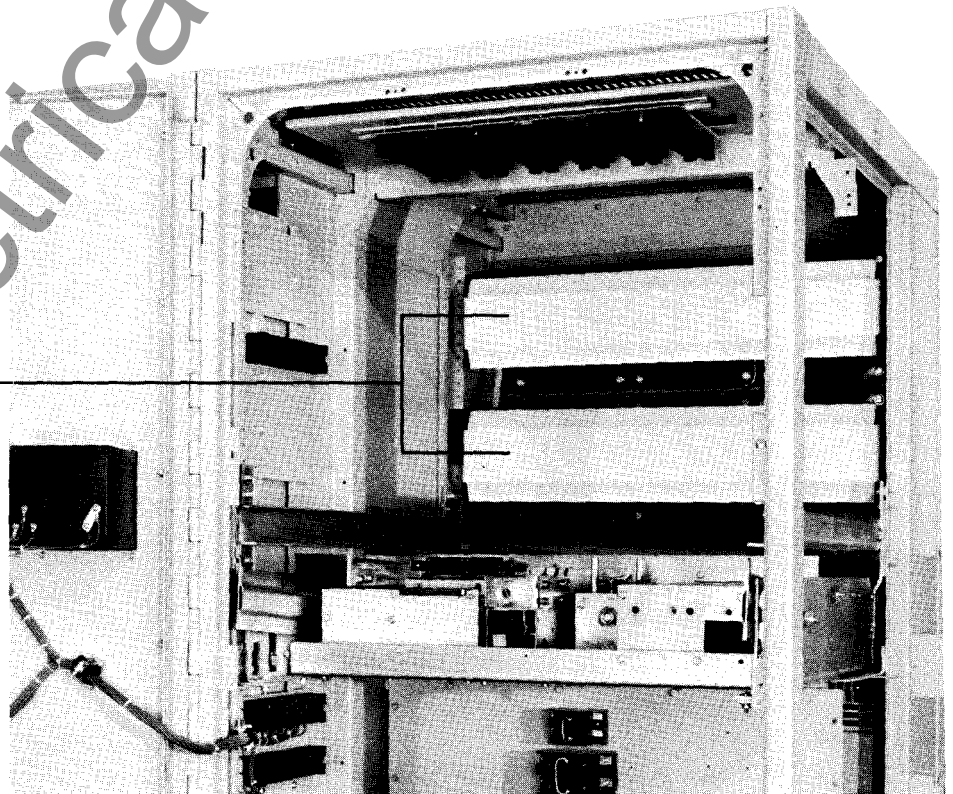

www.ElectricalPK.com



Performance

Cell Features

The breaker compartment is shown with barriers removed and the automatic steel shutters forced into the open position.

Primary insulating tubes (15 Kv porcelain – 5 Kv flame retardant, track resistant glass polyester) and current transformer location are shown in this view. Primary stationary cell studs are also visible.

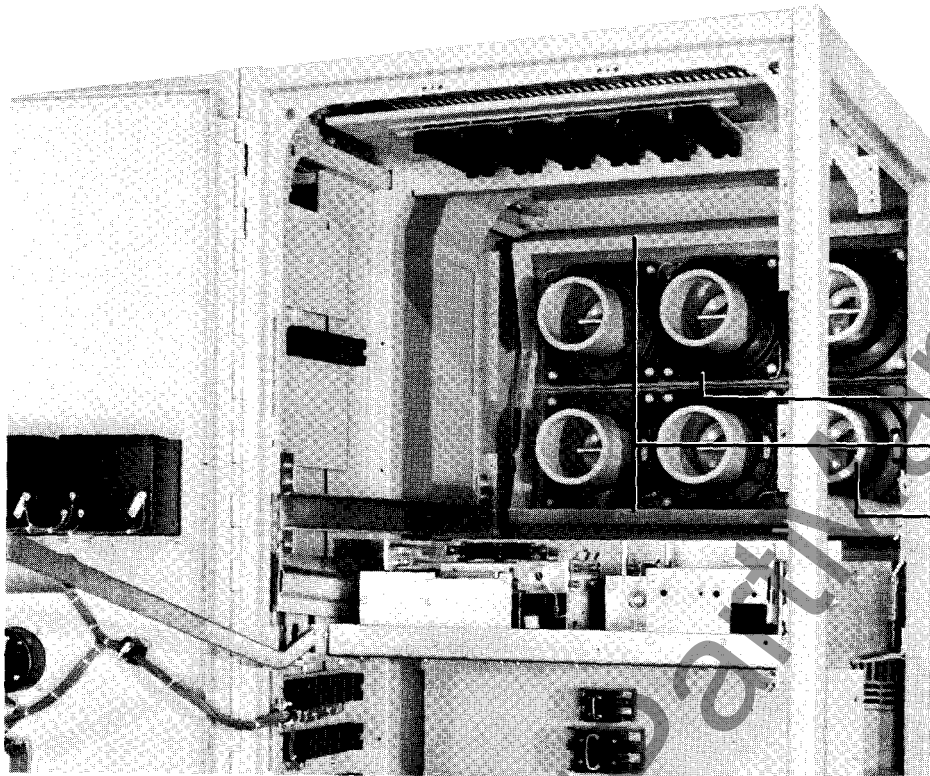

- Current Transformers
- Automatic Steel Shutters
- Primary Insulating Tubes

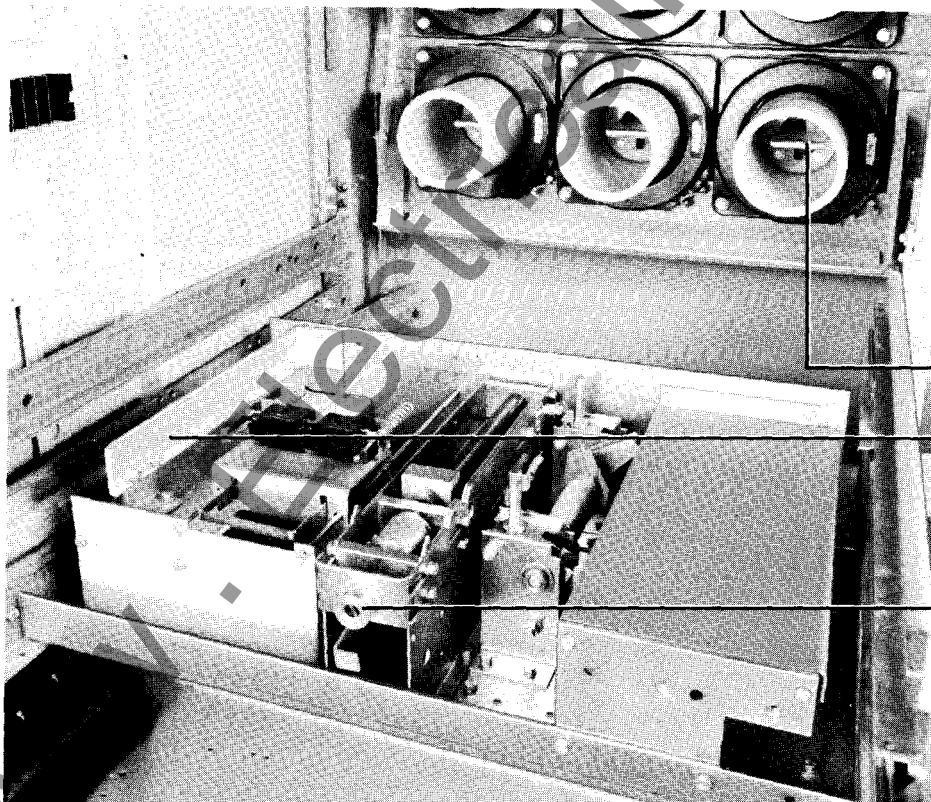

The mechanism for levering the breaker is a unique cell mounted design. This levering system incorporates all the safety interlocks to render the breaker mechanically and electrically trip-free during the levering procedure. In addition, the system is spin-free at the end of the breaker travel, in or out, which prevents over tightening and possible damage. Further, the ground bus, visible on the left, is engaged by a disconnecting finger on the breaker, so the breaker is grounded throughout the travel.

- Cell Studs
- Ground Bus
- Levering Mechanism

Note: Shutters should be removed or forced into the open position only when the unit is de-energized. Shutters are shown in the open position for illustrative purposes only.

Performance

Cell Features

Main Bus

The main bus standard conductor is aluminum for 2000 amps and below. All main bus has fluidized bed epoxy flame retardant track resistant insulation. The bolted bus connections are tin plated for positive contact and low resistance, with each joint insulated with easily installed boots.

The main bus supports are flame retardant track resistant glass polyester with porcelain inserts at 15 Kv.

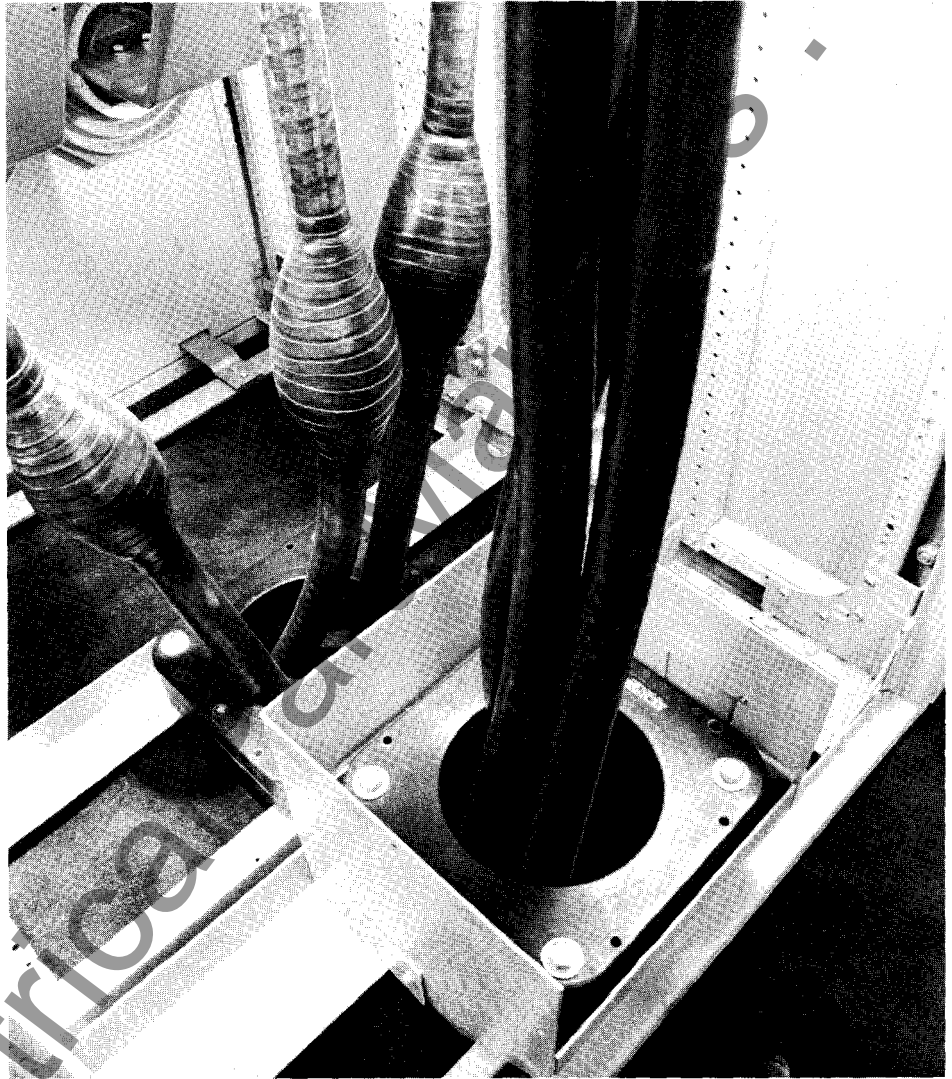
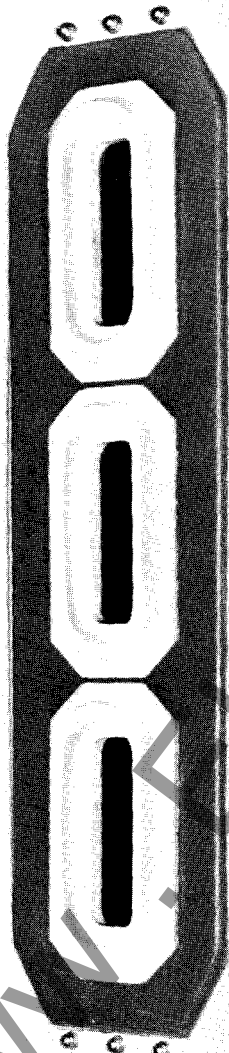

Cable Compartment

The cable compartment in a typical two-high unit provides ample space for cable termination and stress cones (up to 4-750 MCM per phase). In this view, the cover is removed to show the zero sequence current transformers. The stand-off supports are porcelain. Pothead terminations are easily accommodated. Top or bottom entrance is standard.



Performance

Cell Features

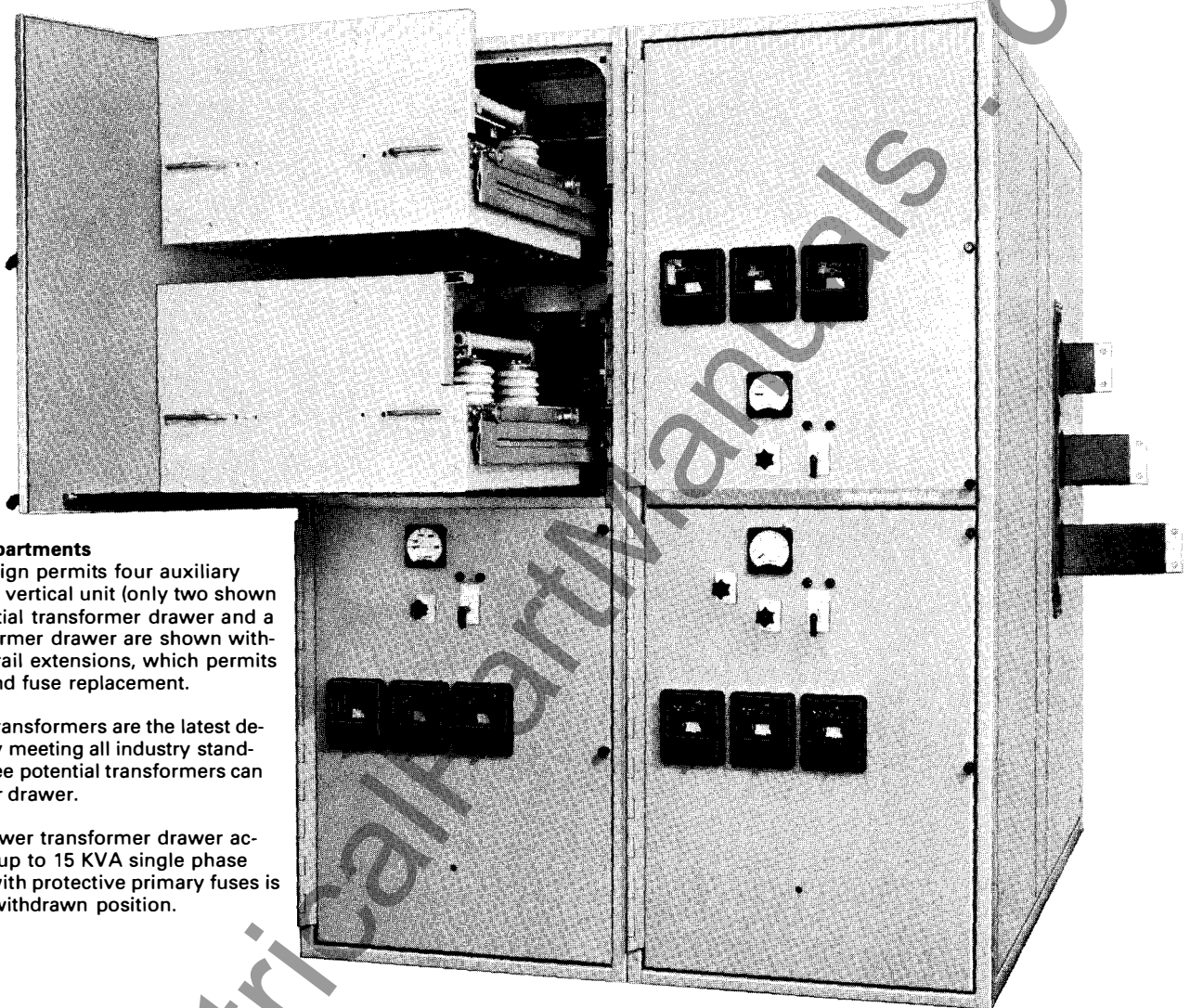

Auxiliary Compartments

VAC-CLAD design permits four auxiliary drawers in one vertical unit (only two shown here). A potential transformer drawer and a control transformer drawer are shown withdrawn on the rail extensions, which permits easy testing and fuse replacement.

- ① The potential transformers are the latest design cast epoxy meeting all industry standards. Up to three potential transformers can be supplied per drawer.
- ② The control power transformer drawer accommodating up to 15 KVA single phase transformers with protective primary fuses is shown in the withdrawn position.

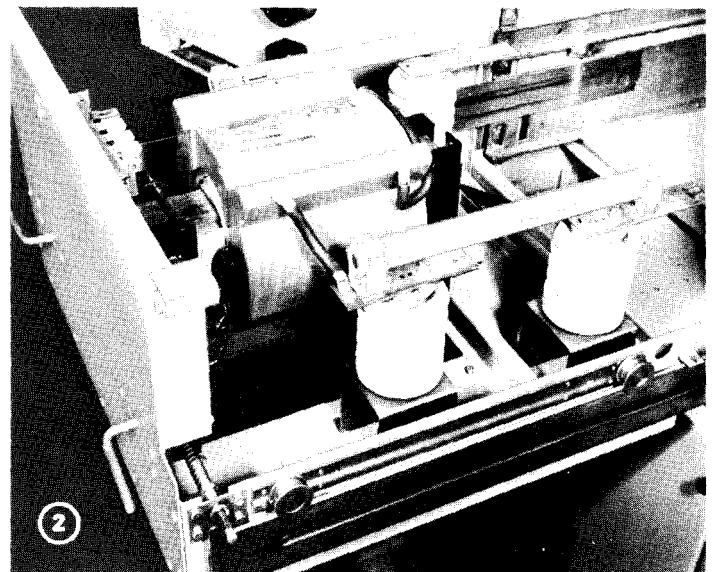
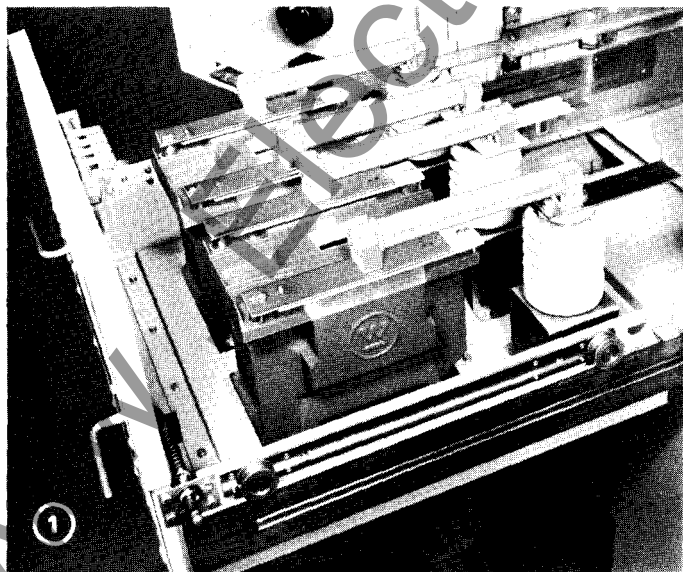

Performance

Breaker Features

The Type VCP circuit breaker, utilizing vacuum interrupters, is compact and light weight. The breaker includes four major components.

- (1) Vacuum interrupter pole units
- (2) Stored energy mechanism enclosed in metal housing
- (3) Porcelain supports for mounting vacuum interrupter pole unit, and
- (4) Primary disconnecting contacts.

Porcelain Insulation

The Type VCP breaker utilizes porcelain insulation (including operating rod) on all live parts to ground.

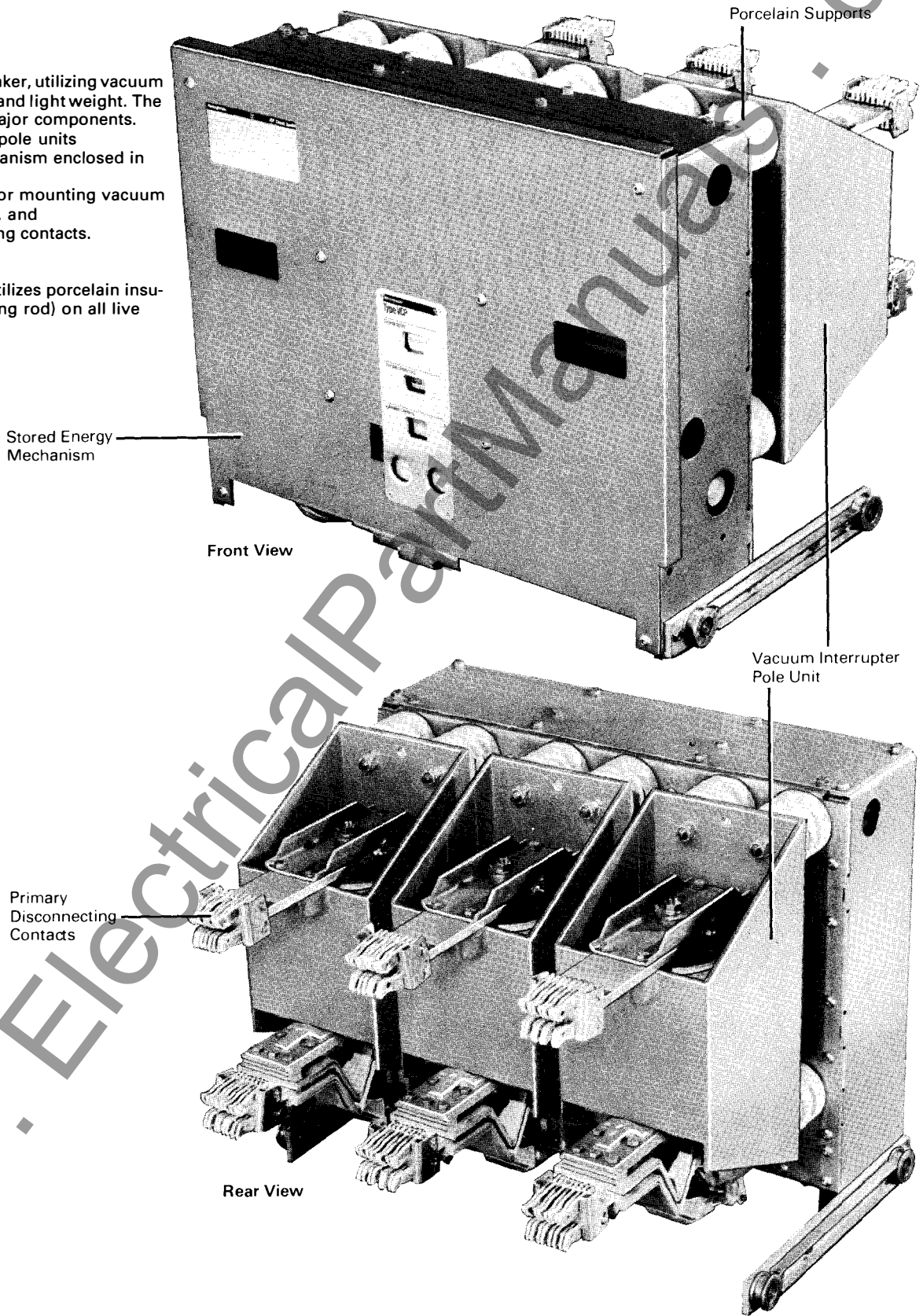



www.electrical.com

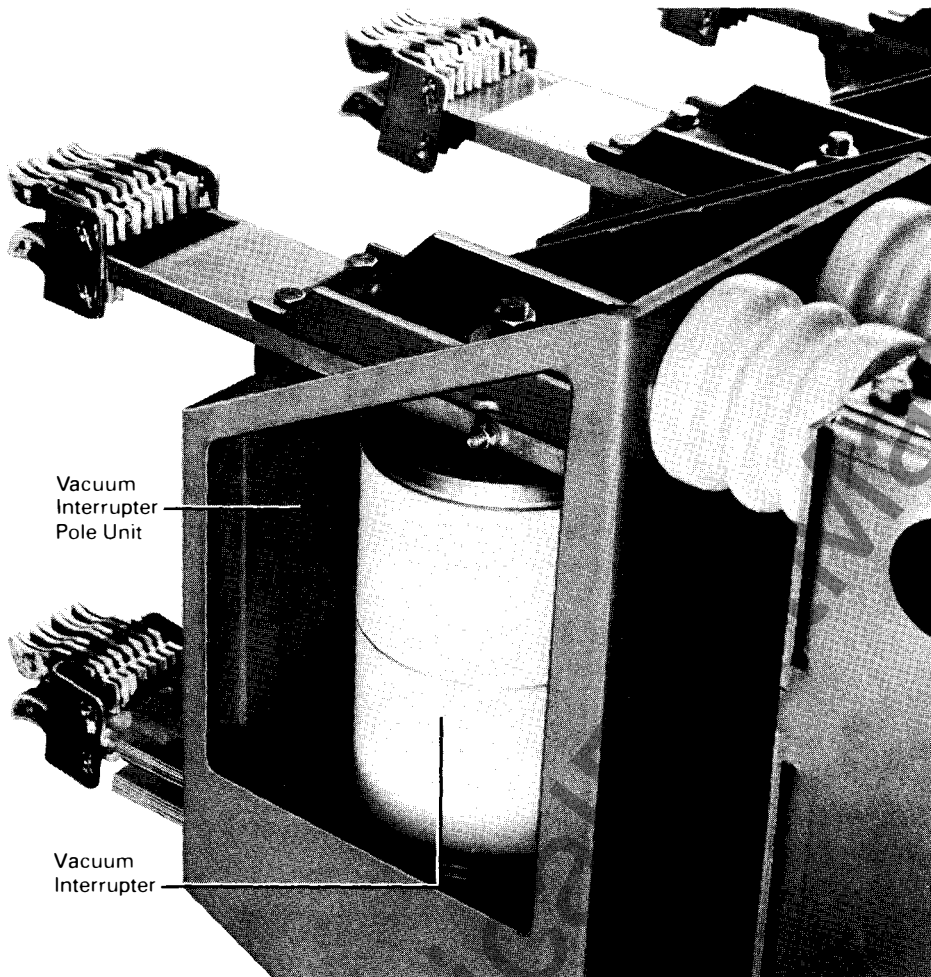

Performance

Breaker Features

Vacuum Interrupter Mounting

An important feature is the vacuum interrupter mounting in a self-contained, self-aligning glass polyester housing (shown with one side cut away), which can be removed as a complete unit. Glass polyester insulation is flame retardant, and track resistant with high mechanical strength, especially selected for this application.

Breaker Front Panel

The 11 gauge steel breaker front panel is designed with the operator in mind. The breaker function indicators and controls are accessible and visible. They are: breaker-open/close, closing spring-charged/discharged, close and trip buttons, and operation counter.

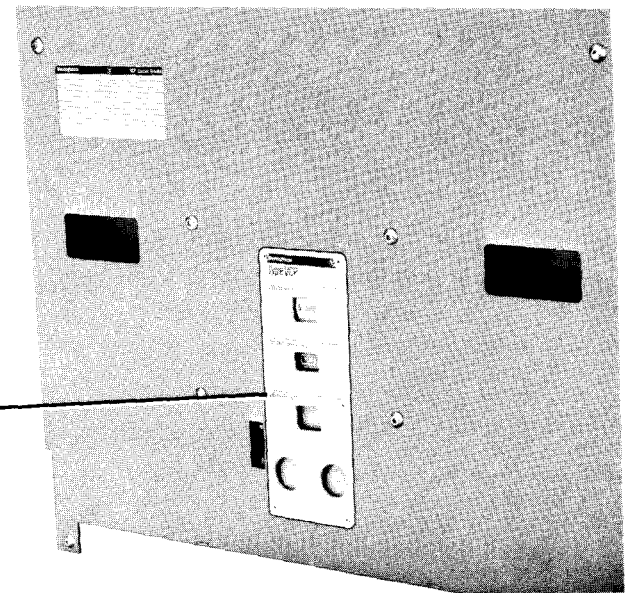
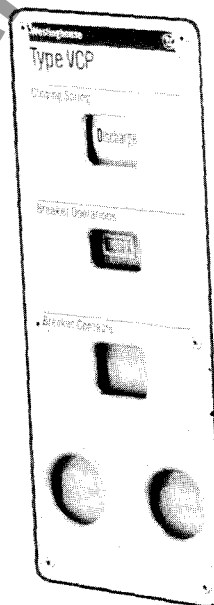

**Performance
Breaker Features
Stored Energy Mechanism**

Breaker front panel removed exposing the stored energy mechanism.

The stored energy mechanism is vertically mounted on the front of the breaker for easy access. There is one basic mechanism for all ratings and is of rugged fabricated steel construction for reliable operation and long life. It is available for either DC or AC operation.

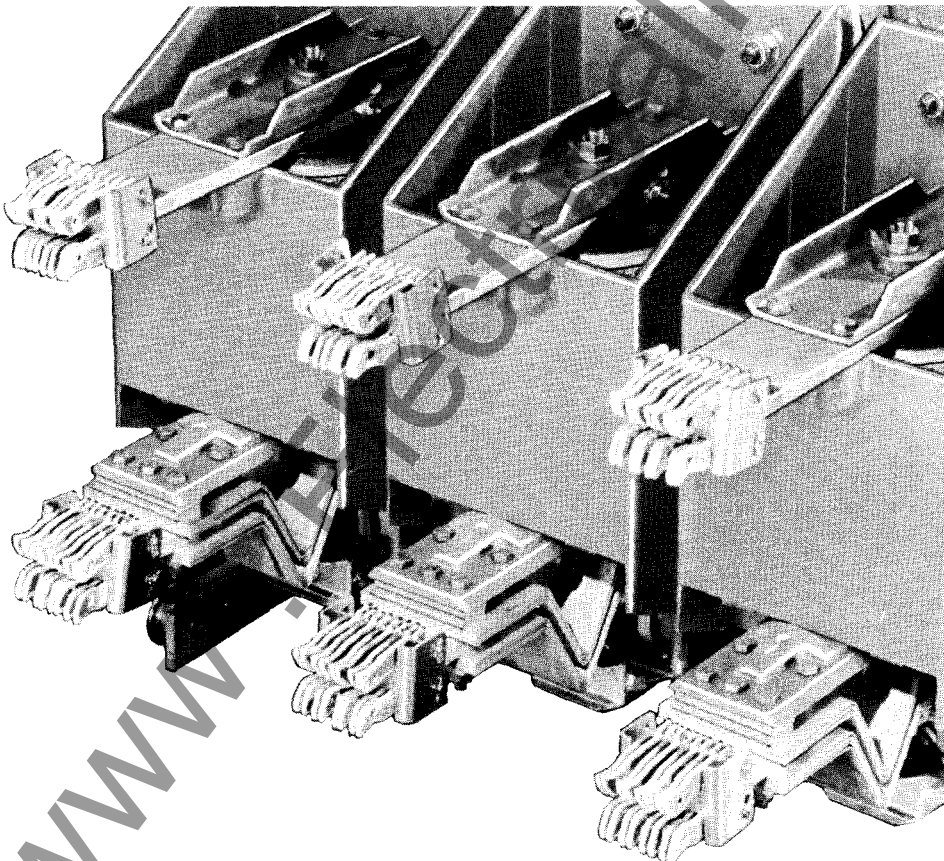
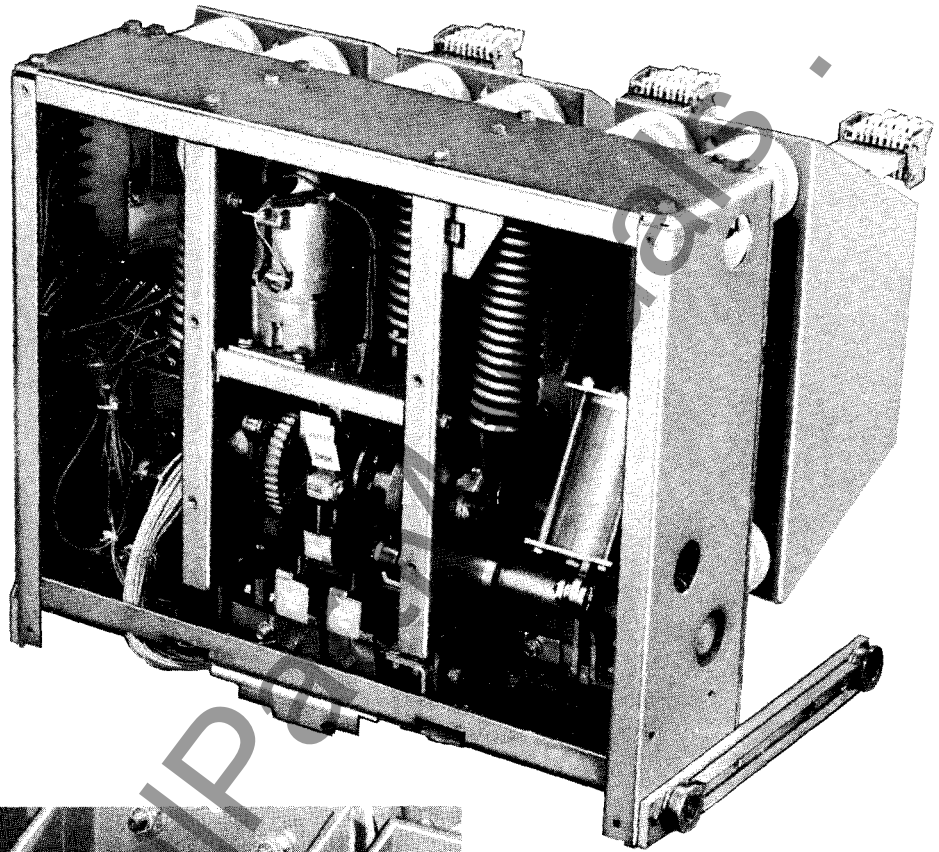

Primary Disconnecting Contacts

The primary disconnecting contacts are silver-plated copper-spring biased to maintain contact pressure. The primary contact design of the configuration shown is for 2000 amp continuous and below. The 3000 amp design uses a cylindrical configuration with individual leaf springs for contact pressure. Both designs have a long service life record, having been successfully used on previous designs of Westinghouse breakers.

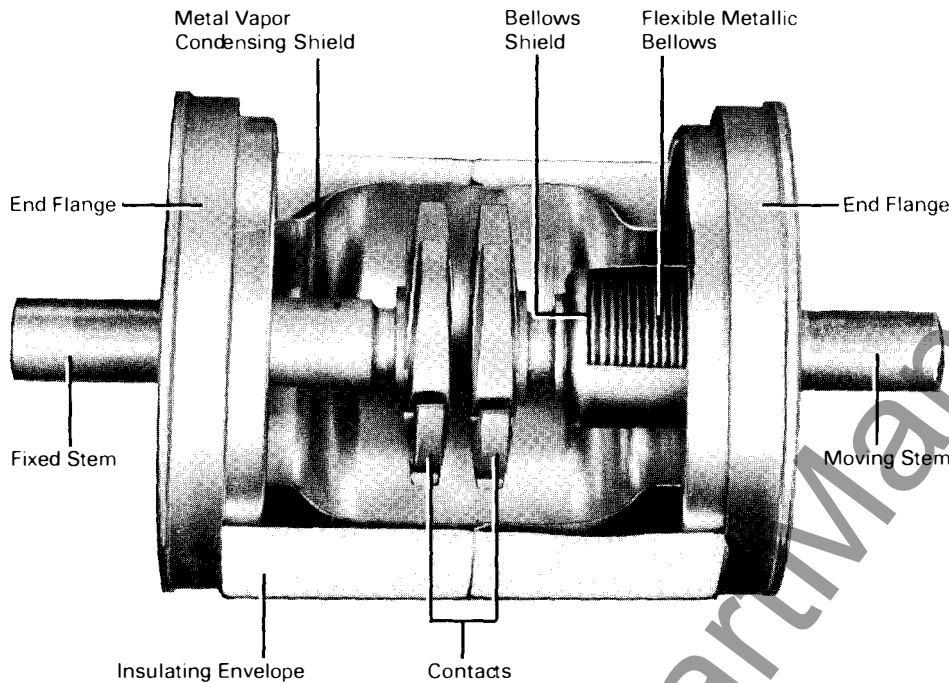

Performance Breaker Features

Vacuum Interrupter

The Type VCP breaker for VAC-CLAD Metal-Clad utilizes vacuum interrupters for interruption and switching functions. Vacuum interruption was chosen for VAC-CLAD due to the characteristics of vacuum interrupters – enclosed interrupter, small size and weight, interrupting time (high speed), long life, reduced maintenance, and environmental compatibility (low noise, no arc by-products, and minimum mechanical shock).

Arc interruption is simple and fast. The vacuum interrupter is shown. In the closed position normal current flows thru the interrupter. When a fault occurs and interruption is required, the contacts are quickly separated. An arc is drawn between the contact surfaces and is rapidly moved around the slotted electrode surface by self-induced magnetic effects, which prevents gross electrode erosion and the formation of hot spots on the surface. The arc burns in an ionized metal vapor, which continually leaves the contact area and condenses on the surrounding metal shield.

At current zero, the arc extinguishes, vapor production ceases; and very rapid dispersion, cooling, recombination, and deionization of the metal vapor plasma together with the fast condensation of metal vapor products cause the vacuum condition to be quickly restored – hence the separated contacts withstand the transient recovery voltage.

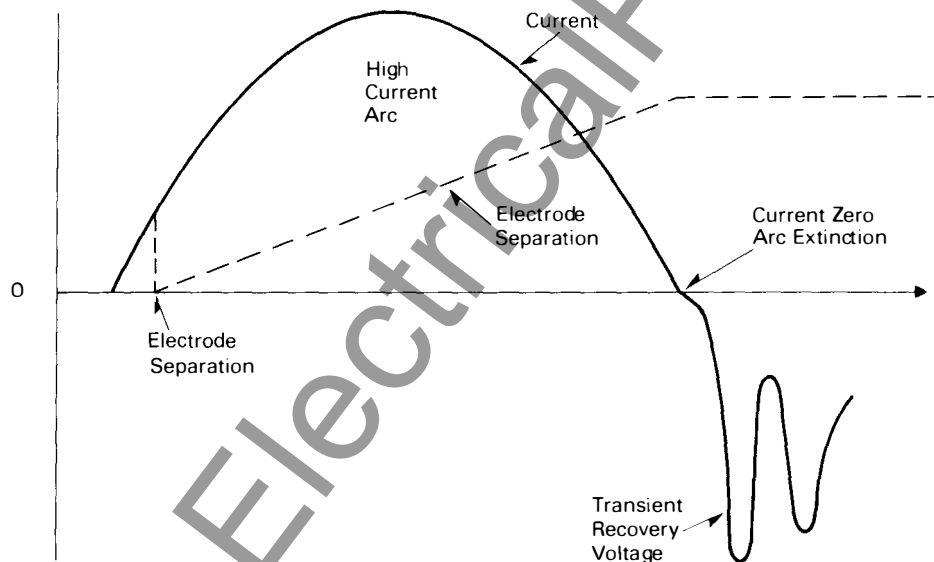

The current, voltage, and contact separation interrelationship is illustrated above.

www.ElectricalPart.com

com

**Safety
Cell and Breaker Features**

VAC-CLAD Metal-Clad Switchgear incorporates many outstanding safety features, which meet or exceed those required by metal-clad standards.

Some of the outstanding features are:

Safety Metal Shutters

Steel shutters (breaker driven) rotate automatically into position to cover the insulating tubes to provide metal barriering of the cell stationary studs when the breaker is withdrawn from the connected position.

Grounded Metal Barriers

Grounded metal barriers separate all compartments, completely enclosing major parts of the primary circuit, main bus, breaker, potential transformers and control power transformers. These barriers must be removed to gain access to any energized compartment. All control devices are separated from high-voltage circuits by grounded metal barriers.

Levering System

Operators and equipment are both protected by a variety of interlocks on the breaker assembly.

1. A breaker cannot be levered unless the interrupter contacts are open.
2. Breaker is trip-free mechanically and electrically during levering.
3. Levering mechanism disengages (spins-free) when the breaker levering is completed (in or out).
4. Closed door levering.

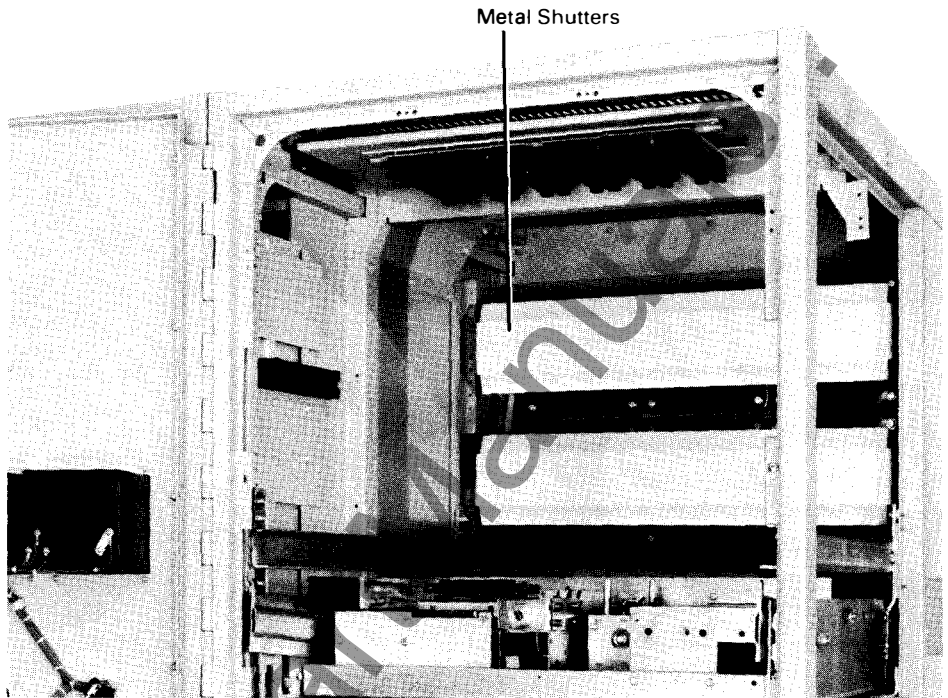

VAC-CLAD Cell with Interphase Barrier Removed

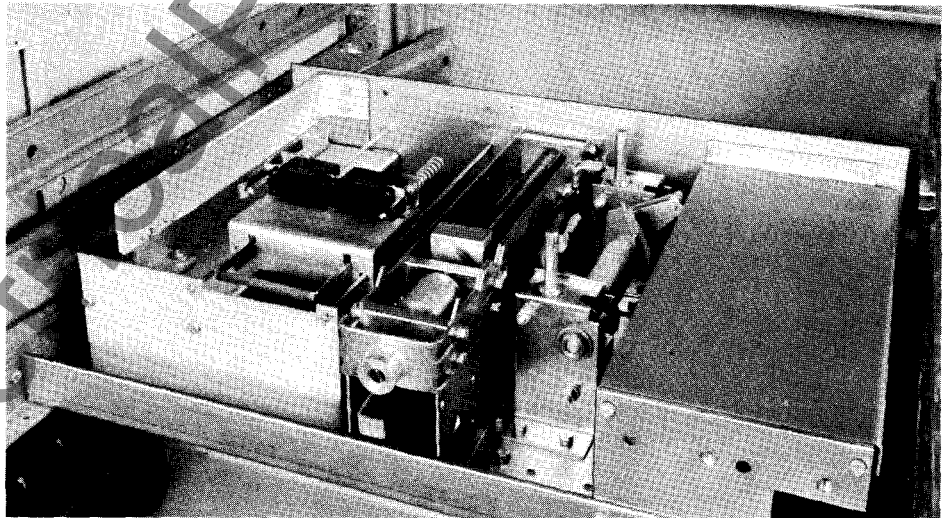

Cell Mounted Levering System

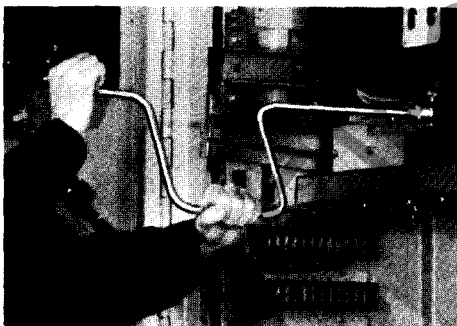

Levering Crank Operation (with door open for illustrative purposes)

5. Discharge of closing spring as breaker is withdrawn from the cell.
6. A latch secures the breaker in the disconnected or test position.

Breaker

- Breaker is grounded during levering and in the connected position.
- Front panel – steel barrier.
- Coding plates provide that only correct breaker rating can be installed in cell.

WWW



Maintenance

Cell Features

Auxiliary Equipment

Control power transformers with current-limiting fuses and potential transformers are drawer-mounted in enclosed compartments. These compartments are automatically disconnected and grounded, when the drawer is withdrawn from the compartment on the extendable rails.

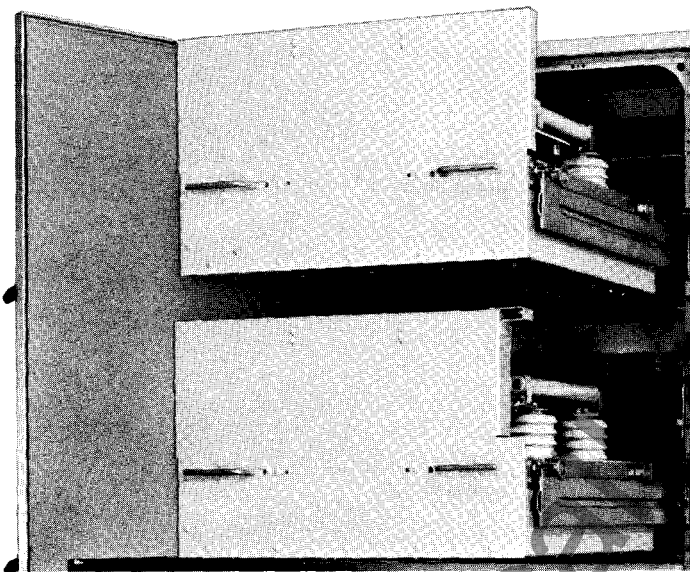

Current Transformers

Current transformers are accessible from the front. This design and front accessibility permit adding or changing transformers when the unit is deenergized without handling high-voltage connections or breaking primary insulation.

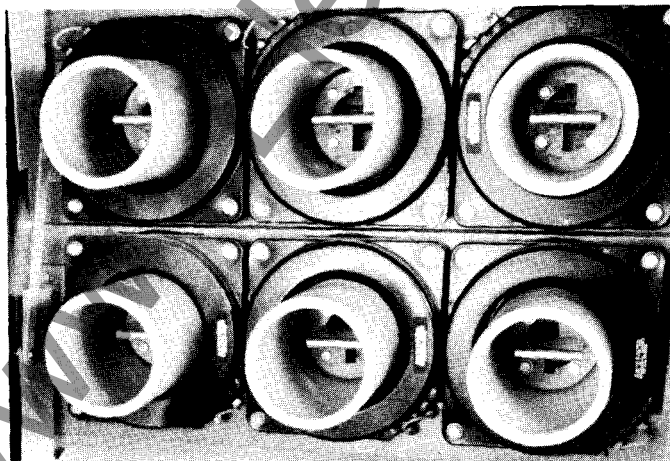

Cable Accessibility

The design provides adequate space for cable termination in the two high arrangement with cable for each circuit separated by metal barriers. Barriers are easily removed as shown.

Maintenance

Breaker Features

- Normal inspection – Breaker can be withdrawn on extendable rails for easy access without requiring separate lifting device.
- Mechanical inspection – Easy inspection and accessibility is afforded by the front mounted stored-energy mechanism. The same basic mechanism is used in all ratings, which requires a minimum investment in spare parts.

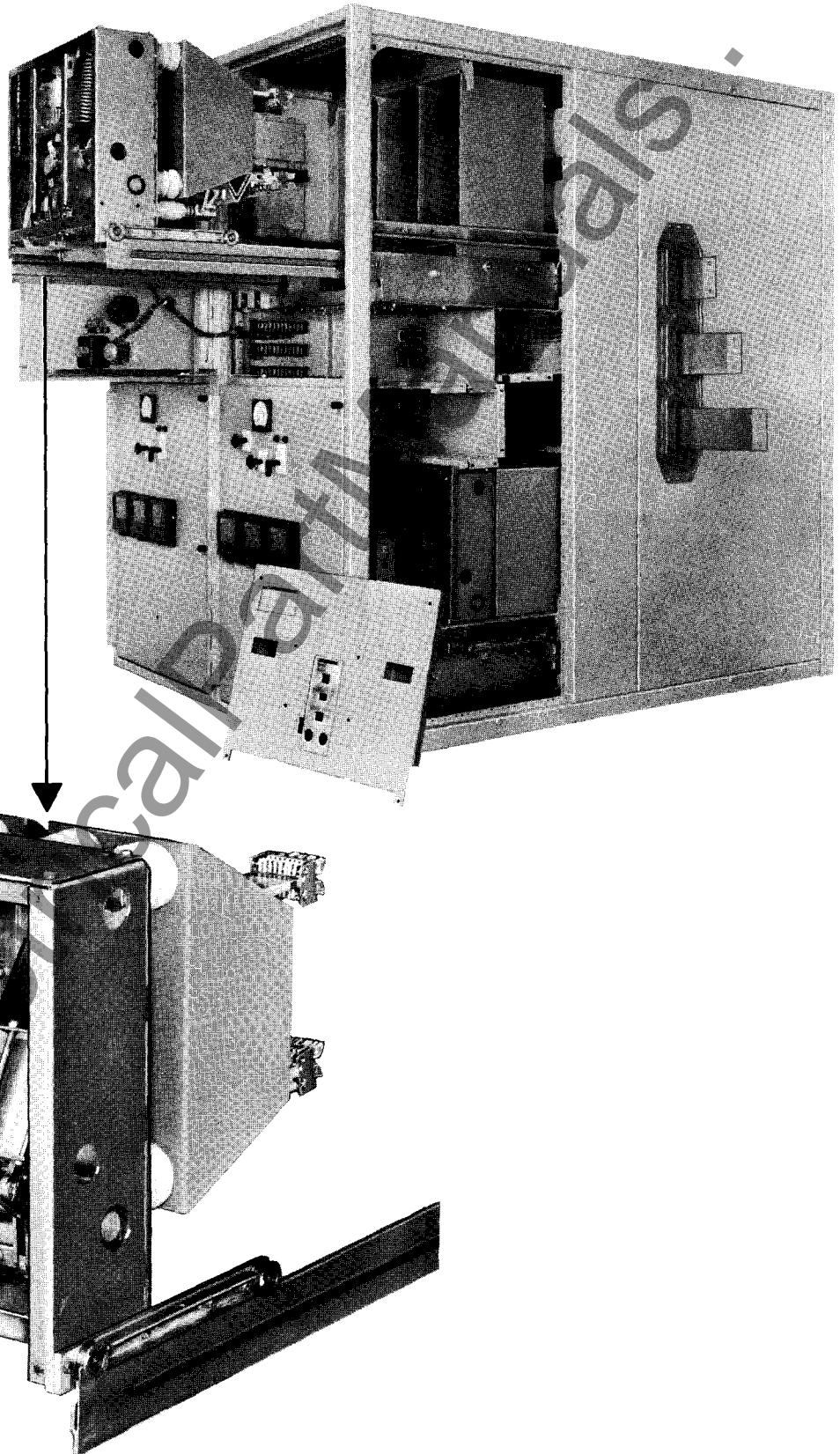



Maintenance

Breaker Features

- The interphase barrier assembly is part of the switchgear cell. When the breaker is withdrawn, inspection of the breaker is unobstructed.

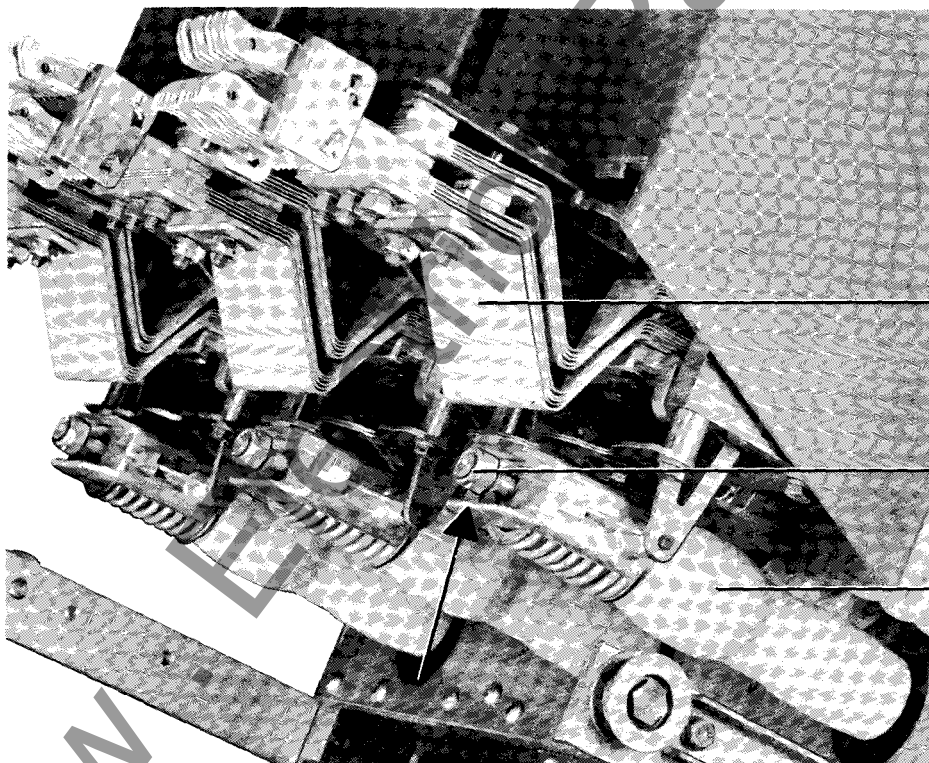

Vacuum Interrupter/Main Conductor Current Transfer

Current transfer from the vacuum interrupter moving stem to the breaker main conductor is a non-sliding design – thus eliminating the maintenance required with sliding type transfer arrangements.

Vacuum interrupter contact wear indicator
Clearly visible, wear-gap (contact erosion) indicators, magnify contact wear about 250%. The contact wear requires only an occasional check.

Porcelain operating rod easily cleaned.

Reduced Maintenance

Due to the inherent long life characteristics of the vacuum interrupter and the reliable stored-energy mechanism, the type VCP breaker requires minimum maintenance.

Space Utilization

VAC-CLAD Switchgear has been designed for efficient use of space. In many situations, total required floor space may be reduced by as much as 50% compared to conventional switchgear.

The rail extension feature for breaker drawout provides for side access for breaker lifting, which reduces breaker withdrawal space requirements. Compare this with other designs, which require front lifting.

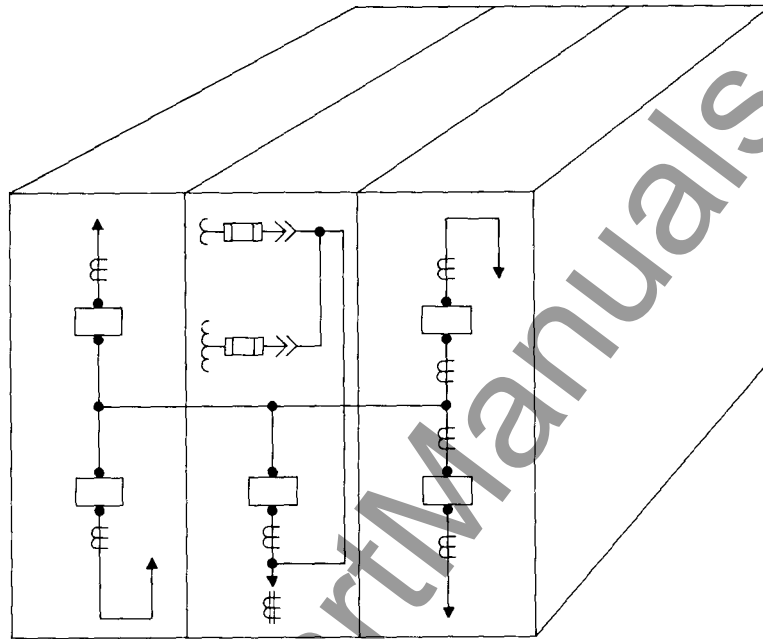

VAC-CLAD

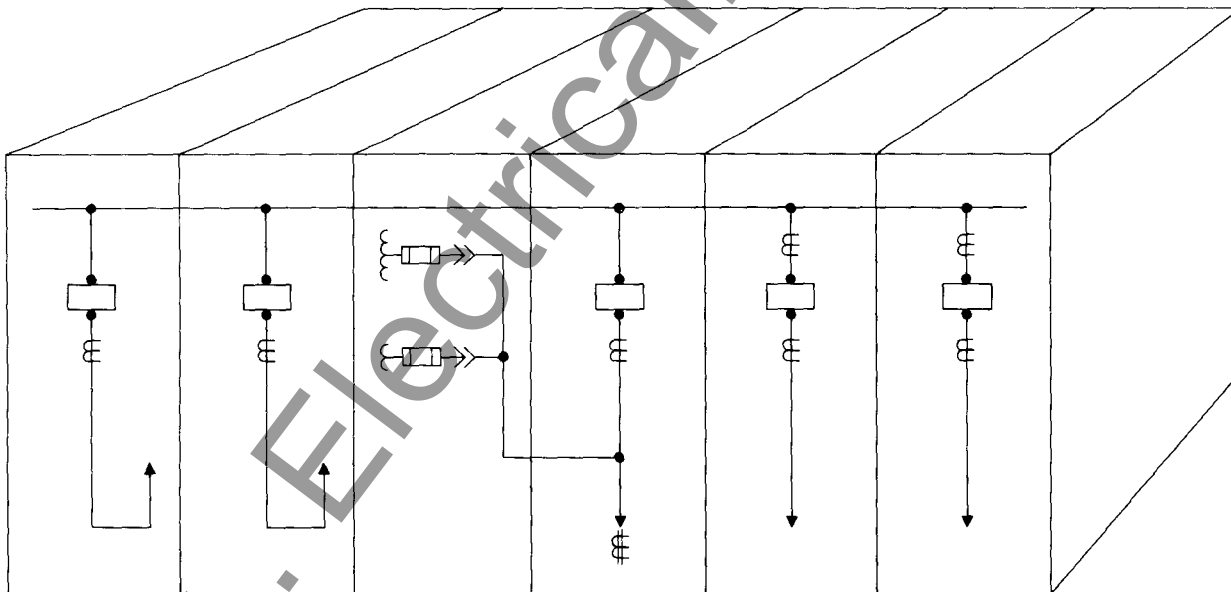

Conventional Switchgear

www.ElectricalPartManuals.com



Application Flexibility

VAC-CLAD has the flexibility to meet most installation conditions or requirements.

- One-high combinations can be provided.
- Unitized and bolted construction provides for ease of assembly, initial flexibility of installation, and future expansion or modification.
- Rear compartments are designed for either top or bottom entry of cable or bus runs.
- Provisions for six current transformers (4 per phase) on both the bus and line side of circuit breakers .
- Provisions for as many as four sets of drawout transformers in one vertical section.
- Indoor and outdoor (aisleless and sheltered aisle).
- Complete ANSI rating range available, plus several special ratings.

Reliability

Reliability is a fundamental aspect of VAC-CLAD Metal-Clad Switchgear. It was the fundamental consideration of engineering design, material selection, use and design of components, manufacturing, test procedures, shipping and handling to assure the user of on-site reliability.

• Engineering Design

The VAC-CLAD designers' primary assigned objective was a reliable product. All parts and operational functions were conceived with reliability in mind. This design objective manifests itself in three ways: 1. a minimum number of parts; 2. selection of quality material; 3. maximum use of tested, proved parts. All design criteria were set above the levels required for proper equipment functioning.

• Material Selection

Specific technical disciplines were assigned the task of material selection and verification by laboratory tests for the specific application – i.e., porcelain, glass polyester, fluidized bed epoxy, breaker mechanism parts, etc.

• Components

The vacuum interrupters were designed specifically for the ratings and other factors required for Metal-Clad Switchgear: interrupting, voltage, and mechanical and electrical life ratings, mounting requirements, and many others. The vacuum interrupters, by the nature of the manufacturing procedures, are produced by the most exacting quality and reliability techniques.

Other components, such as auxiliary switches, bus insulation, instrument transformers and control wire, were all subjected to reliability procedures peculiar to the particular type of component.

• Manufacturing

Because VAC-CLAD Metal-Clad Switchgear is a highly tooled product, it has a high degree of accuracy and consistency of parts. The most modern manufacturing techniques and facilities are used to make this switchgear. The facilities include computer-aided drafting and manufacturing-information systems, and numerical controlled machines, process equipment and order follow.

• Design/Proof Tests

VAC-CLAD Metal-Clad Switchgear meets all applicable ANSI, IEEE, and NEMA standards. The design criteria dictated that all tests demonstrate performance above the requirements of the standards. The ANSI test series is basic test criteria and includes interruption (over the complete current range), BIL, dielectric, continuous current, mechanical life, and thermal and environmental conditions.

The design/proof testing of VAC-CLAD Switchgear is the most extensive ever performed by the Westinghouse Switchgear Division which has always maintained the highest test standards for its metal-clad equipment.

• Production Tests

Circuit Breaker

- Each breaker draw-out unit is checked for alignment with a master cell fixture that verifies all interfaces and interchangeability.
- All circuit breakers are operated over the range of minimum to maximum control voltage.
- Interrupter contact gap is factory set.
- One-minute dielectric test is performed on each breaker per ANSI Standards.
- Final inspection and quality check.

Housing

- Master breaker fixture is inserted into each breaker cell to ensure alignment.
- One-minute dielectric test per ANSI Standards is applied to both primary and secondary circuits.
- Operation of wiring, relays, and other devices is verified by an operational sequence test.
- Final inspection and quality check.

• Shipping and Handling

Complete assemblies and breakers have been shipped from one location to another to verify the packing and handling procedures and assure the customer that the equipment will arrive in excellent condition.

Supplemental Device

• Ground and Test Device

The ground and test device is a drawout element that may be inserted into a Metal-Clad Switchgear housing in place of a circuit breaker to provide access to the primary circuits to permit the temporary connection of grounds or testing equipment to the high voltage circuits. High potential testing of cable or phase checking of circuits are typical tests which may be performed. The devices are insulated to suit the voltage rating of the switchgear and will carry required levels of short circuit current.

Both manual and electrically operated ground and test devices are available. These devices include six studs for connection to primary circuits. On the manual device, selection and grounding are accomplished by cable connection. On the electrically operated device, a two position switch provides for correct selection of the proper primary circuit. Grounding is accomplished by an electrically operated stored energy ground switch.

Notice

Before using ground and test devices it is recommended that each user develop detailed operating procedures consistent with safe operating practices. Only qualified personnel should be authorized to use ground and test devices.

Standard Accessories:

- 1 – Test Jumper
- 1 – Levering Crank
- 1 – Maintenance Tool
- 1 – Lifting Yoke
- 1 – Set Rail Clamps
- 1 – Transport Dolly
- 1 – Portable Lifter (Optional)
- 1 – Test Cabinet (Optional)

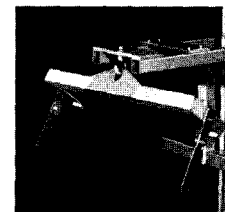

Universal Breaker
Lifting Yoke
For User's Lifting
Device

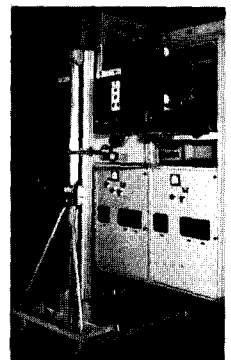

Optional Portable
Lifter

Standardized Function Designs

Standardized designs have been pre-engineered to provide ease of selection of control and protection functions. These designs are incorporated in a computer aided design program. By selection of standard arrangements, complete mechanical drawings and bill of material can be provided with the proposal in sufficient detail that they constitute drawings for approval. Obviously, this procedure shortens the total cycle time, thus assuring the shortest possible delivery.

See Application Data 32-264 for functions available.

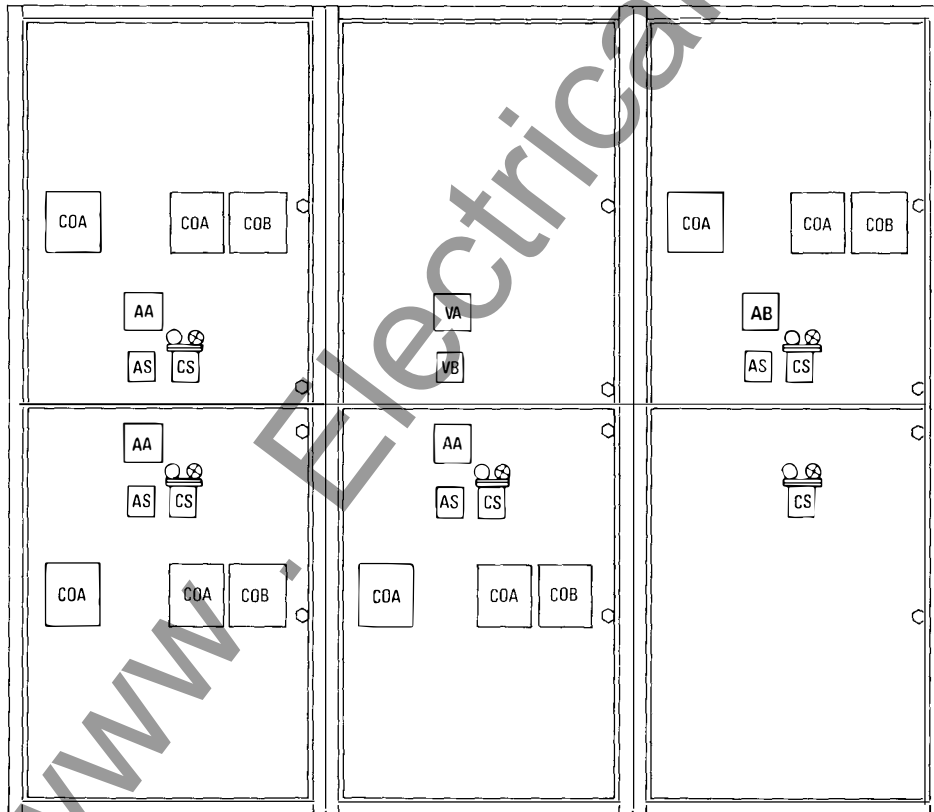
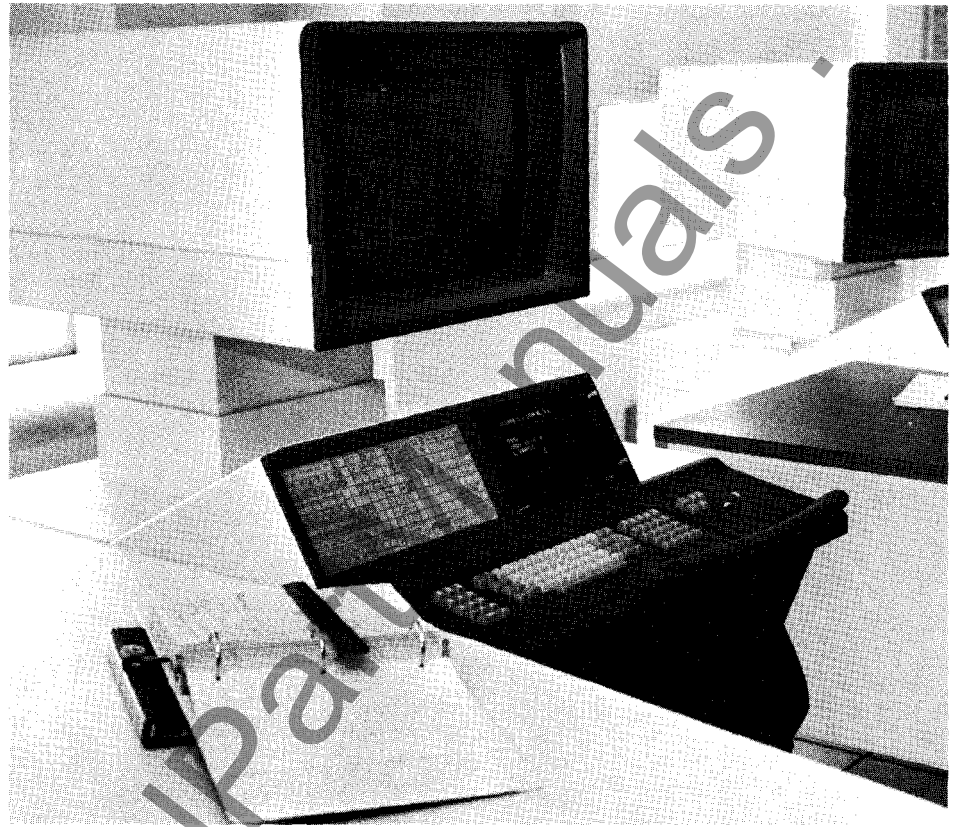

List of Components

ITEM	DESCRIPTION
AA	AMMETER, AC, KA241 0-1200A
AB	AMMETER, AC, KA241, 0-2000A
AB27	MOLDED CASE, AB, 2P, 70A
AS	AMMETER SWITCH, H2
COA	O.C. RELAY, CO8, 1-12A, 6-144A
COB	O.C. RELAY, CO8, 5-2.5A, 2-48A
COVA	O.C. REL. VOLT RES. COVB, 2-6, 10-40
CPD	CAPACITOR TRIP DEVICE
CS	CONT. SWITCH, BKR, W2
CT1	COPPER CONDUCTOR, TINNED 1200A
CT2	COPPER CONDUCTOR, TINNED 2000A
CTX	CURRENT TRANSFORMER
DL3	D.O. CPT. ONE PH, L-L, 15KVA 12470-120/240
FHF2	FUSE HOLDER, FIXED, 2P
FHF3	FUSE HOLDER, FIXED, 3P
FHP2	FUSE HOLDER, PULLOUT, 2P
FQ6	FUSE, 6A
F30	FUSE, 30A
O	GREEN LIGHT
GB	GROUND BUS, COPPER



Weights and Dimensions

**Typical Weights (Pounds)
Assemblies (Less Breakers)**

Type of* Vertical Section	Main Bus Rating Amps	Indoor	Aisle-Less	Sheltered-Aisle Including Aisle	
				Single Row	Double Row
B/B	1200	2400	3000	4200	7200
	2000	2500	3100	4300	7400
	3000	2600	3200	4400	7600
B/A or A/B	1200	2300	2900	4100	7000
	2000	2400	3000	4200	7200
	3000	2500	3100	4300	7400
A/A	1200	2000	2600	3800	6400
	2000	2100	2700	3900	6600
	3000	2220	2800	4000	6800
B	1200	2200	2800	4000	6800
	2000	2300	2900	4100	7000
	3000	2400	3000	4200	7200

Breakers

Type of Breaker	Current Rating Amps	Lbs.	Type of Breaker	Current Rating Amps	Lbs.
50VCP250	1200	450	150VCP500	1200	450
	2000	550		2000	550
	3000	650		3000	650
50VCP350	1200	450	150VCP750	1200	450
	2000	550		2000	550
	3000	650		3000	650
75VCP500	1200	450	150VCP1000	1200	450
	2000	550		2000	550
	3000	650		3000	650

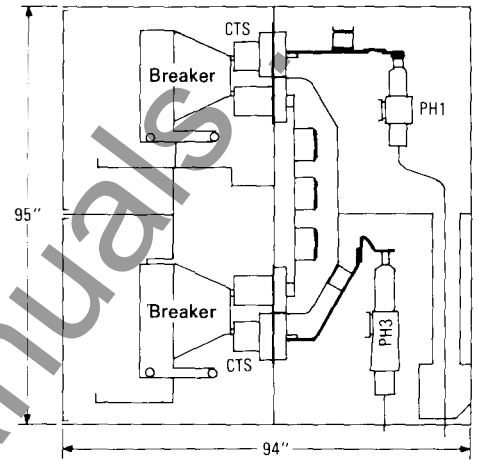

Indoor

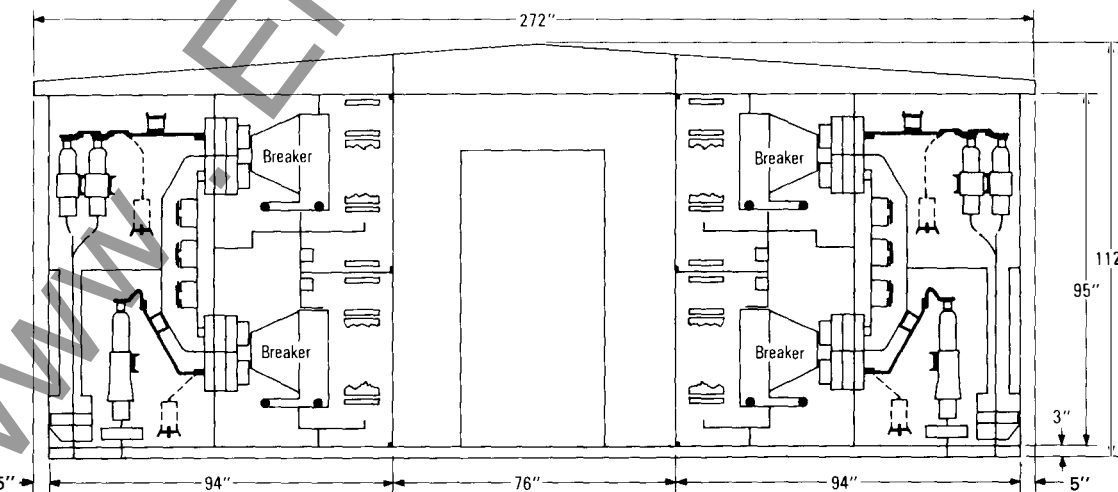
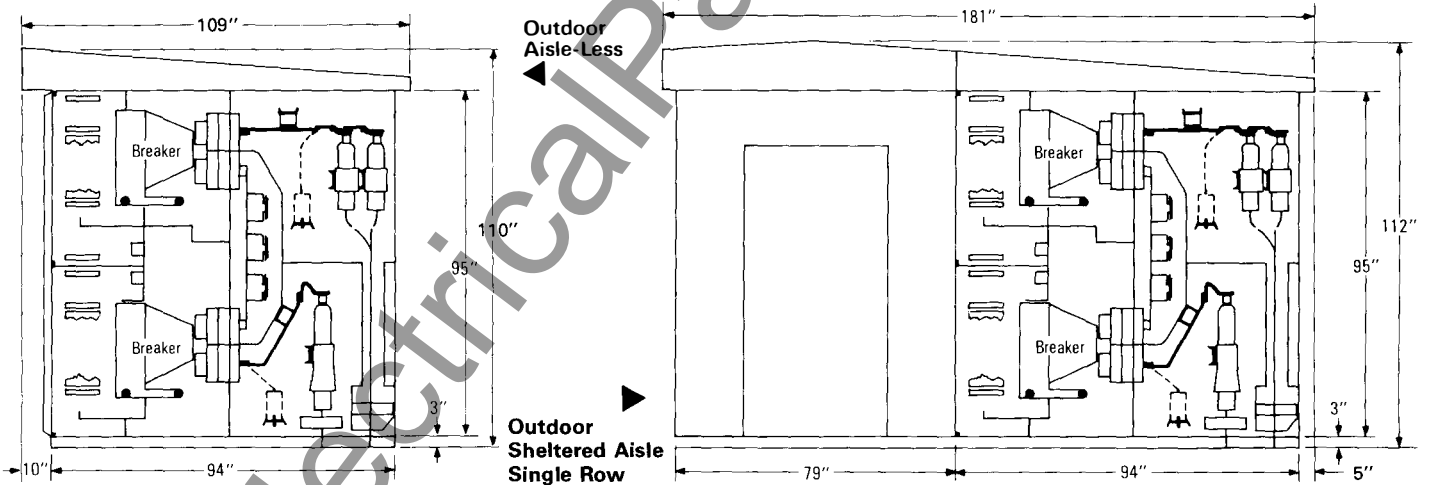

* See Page 22
for Available
Configurations.

Outdoor
Sheltered Aisle
Double Row

Typical Units

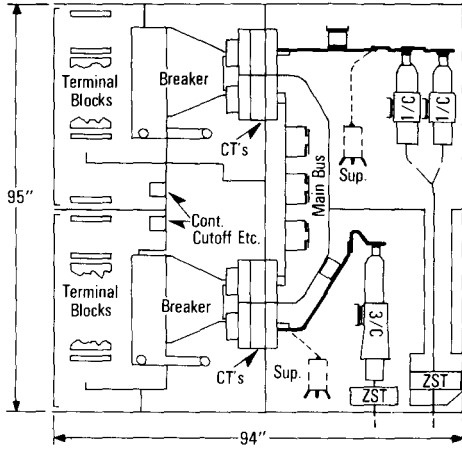

36" Wide Typical Breaker/Breaker Vertical Section

- 1 - 1200/2000/3000 Amp. main bus
- 2 - Type VCP breakers 1200/2000 Amp. in 2 - high configuration
- 4 - Current transformers per phase ANSI ratings.
 - Potheads 1/C or 3/C
 - Surge suppressors, if desired.
 - Zero sequence current transformer (ZST)

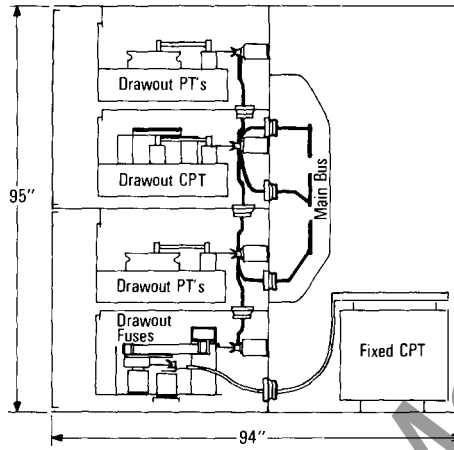

36" Wide Typical Auxiliary/Auxiliary Vertical Section

- 1 - 1200/2000/3000 Amp. main bus. Illustrating maximum utilization of auxiliary compartment with 4 - high drawout auxiliaries and fixed mounted control power transformer.

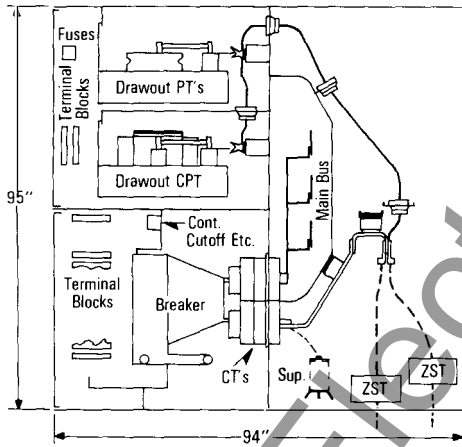

36" Wide Typical Auxiliary/Breaker Vertical Section

- 1 - 1200/2000/3000 Amp. main bus
- 1 - Type VCP breaker 1200/2000 Amp. in lower position
- 1 - Drawout potential transformer drawer
 - 2 - L-L with fuses
 - 3 - L-G with fuses
- 1 - Drawout control power transformer drawer
 - CPT - 15 KVA max - single phase
 - Zero sequence current transformers (ZST)
 - Surge suppressors, if desired.

Available Configurations

1200 Amp Breaker	1200 Amp Breaker	1200 Amp Breaker
1200 Amp Breaker	2000 Amp Breaker	Drawout Auxiliary
Drawout Auxiliary	2000 Amp Breaker	Drawout Auxiliary
1200 Amp Breaker	Drawout Auxiliary	2000 Amp Breaker
Vented Auxiliary Compartment (Non-Drawout)	Drawout Auxiliary	2000 Amp Breaker
3000 Amp Breaker	Drawout Auxiliary	1200 Amp Breaker



com

Table 1: Application: Available Breaker Types Rated on Symmetrical Current Rating Basis

Identification	Rated Values						Related Required Capabilities ^③							
	Nominal Voltage Class	Nominal 3-Phase MVA Class	Voltage Rated Maximum Voltage	Rated Voltage Range Factor	Insulation Level Rated Withstand Test Voltage	Current Rated Continuous Current at 60 Hz	Rated Interrupting Time	Rated Permissible Tripping Delay	Rated Max. Voltage Divided By K	Current Values Maximum Sym. Interrupting Capability	3 Sec. Short-Time Current Carrying Capability	Closing and Latching Capability (Momentary)		
Circuit Breaker Type	Kv Class	MVA Class	E Kvrms	K	Low Frequency Kvrms	Impulse Kv Crest	Amperes	KA rms	Cycles	Sec.	E/K Kvrms	KA rms	KA rms	KA rms
VCP Vacuum Circuit Breaker														
50 VCP250	4.16	250	4.76	1.24	19	60	1200	29	5	2	3.85	36	36	58
H 50 VCP250 ^①							2000							
50 VCP350		350		1.19			1200	41			4.0	49	49	78
75 VCP 500	7.2	500	8.25	1.25	36	95	1200	33	5	2	6.6	41	41	66
150 VCP 500		500					1200	18				23	23	58 ^①
H 150 VCP500 ^①			2000											
150 VCP750	13.8	750	15	1.30	36	95	1200	28	5	2	11.5	36	36	58
H 150 VCP750 ^①							2000	37				48	48	77 ^①
150 VCP1000		1000					3000							

① Non-Standard Breaker with High Momentary Rating available for Special Applications.

② For 3 phase and line to line faults, the sym interrupting capability at a Kv operating voltage

$$= \frac{E}{K_v} \text{ (Rated Short-Circuit Current)}$$

But not to exceed KI.

Single line to ground fault capability at a Kv operating voltage

$$= 1.15 \frac{E}{K_v} \text{ (Rated Short-Circuit Current)}$$

But not to exceed KI.

The above apply on predominately inductive or resistive 3-phase circuits with normal-frequency line to line recovery voltage equal to the operating voltage.

③ For Reclosing Service, the Sym. Interrupting Capability and other related capabilities are modified by the reclosing capability factor obtained from the following formula:

$$R(\%) = 100 - \frac{C}{6} \left[(n-2) + \frac{15-T_1}{15} + \frac{15-T_2}{15} + \dots \right]$$

Where C = KA Sym. Interrupting Capability at the Operating Voltage but not less than 18.

n = Total No. of Openings.

T₁, T₂, etc. = Time interval in seconds except use 15 for time intervals longer than 15 sec.

Note: Reclosing Service with the standard duty cycle 0 + 15s + CO Does not require breaker Capabilities modified since the reclosing capability factor R = 100%.

④ Tripping may be delayed beyond the rated permissible tripping delay at lower values of current in accordance with the following formula:

$$T \text{ (seconds)} = Y \left[\frac{KI \text{ (K Times Rated Short-Circuit Current)}}{\text{Short-Circuit Current Through Breaker}} \right]^2$$

The aggregate tripping delay on all operations within any 30 minute period must not exceed the time obtained from the above formula.

www.ElectricalPartManual.com

www.ElectricalPartManuals.com