

Compact
Interpact
Compact CM

Compact 1991 new products

A short presentation of our most significant innovations.

You will find all relevant technical information in this catalogue.

remote control units for Compact C101N/H/L and C161N/H/L

These remote control units are available in standard and synchro (for C161N/H/L) versions.

The combination Compact C101N/H/L or C161N/H/L + remote control unit replaces the Compact TC160N/L with built-in remote control.

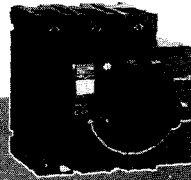

See pages 44, 70 and 74

Compact C801/C1001/C1251N/H/L ST

With a new generation of Solid State Trip Units, offering an answer to all network protection requirements:

- extended setting ranges;
- RMS reading;
- thermal memory;
- a universal Trip Unit (STR 55).

A total protection open to Data Transmission Systems, able to meet any requirement with a large range of combinable options.

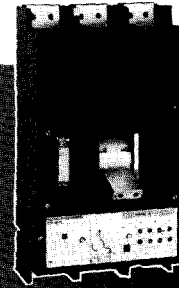

See pages 17 and 94

two drawout chassis for Compact C801 to C1251N/H/L ST

- universal chassis (same approach as Masterpact);
 - through door drawing in and out,
 - through door closing and opening of the breaker,
 - meets all the requirements for incoming breakers;
- basic chassis:
 - drawing in and out with door open,
 - through door closing and opening of the breaker.

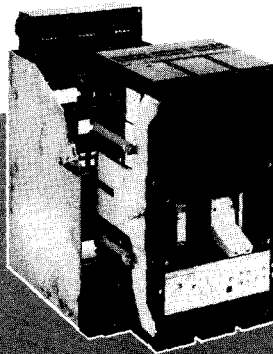

See page 13

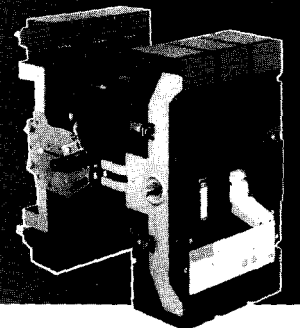

See page 13

new performances for H type

65 kA, according to IEC 947-2 for C101H, C250H, C400H ST, C630H and C630H ST.

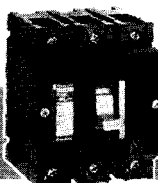

See page 8

Compact system

Compact circuit breakers with thermal-magnetic trip units

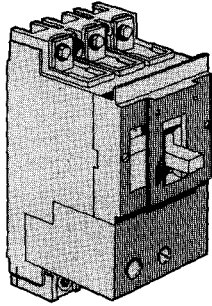

circuit protection and control



D type

protection with low magnetic threshold



G type

selectivity for protection against short-circuit

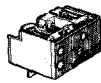

SA SB type

protection of motor starters direct current protection



MA type

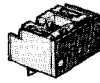

P type

Compact circuit breakers with control units (solid state trip units)

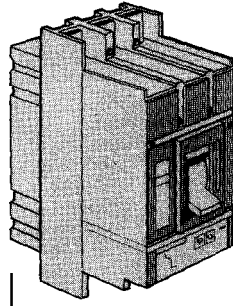

all protections available

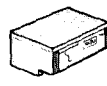

ST204S, ST204SB
STR25DE
STR35SE
STR35ME
STR35GE
STR55UE
STR45BE

models and add-ons

residual current protection

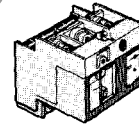

with Vigi module: Vigicompact⁽¹⁾

fully visible break

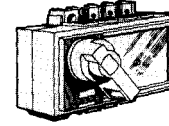

with Visu module: Visucompact

auxiliaries and accessories



electrical auxiliaries

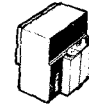

remote control



accessories



connection

page N°

description	6	10	10	10	10	10	10	10	12	13	15	14	15	15
characteristics	19	32	32	32	32	32	20	36	42		54	44	57	61
parts numbers														
C100E	66										67		67	
C225E	66										67	67	67	
C400E	66										67	67	67	
C600E	66										67	67	67	
C100NF	66													67
C101N/H/L	70	70	71	71	71				71		73	71	73	73
C161N/H/L	74	74	76	76	76				75		77	75	77	77
C250N/H/L	78	78	78	78	78				79	80	81	80	81	81
C401N/H/L	82	82		82		82			83	86	87	88	87	87
C630N/H/L	88	88		88		88			89	92	93	94	93	93
C400N/H/L ST							84		85	86	87	88	87	87
C630N/H/L ST							90		91	92	93	94	93	93
C801N/H/L ST							94	94	97	100	98	99	98	98
C1001N/H/L ST							95	95	97	100	98	99	98	98
C1251N/H/L ST							96	96	97	100	98	99	98	98
dimensions	119						119		119	110				

Compact CM

Interpact load break switches

Compact CM with control units (solid state trip units)

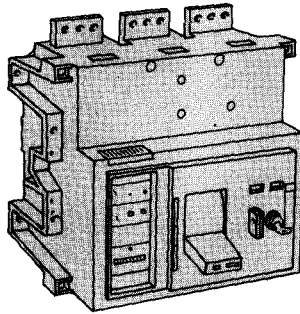

Interpact load break switches

Compact type NI load break switches

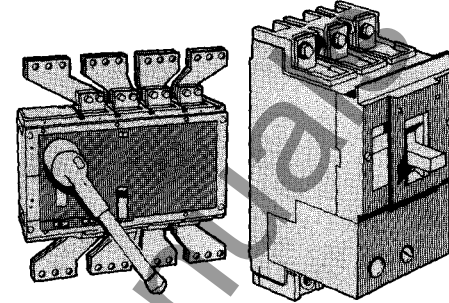

source changeover

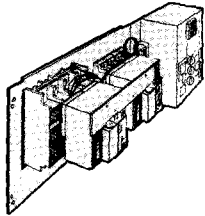

automatic and manual source changeover

circuit protection and control

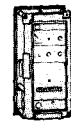

STCM1

selectivity for protection against short-circuit

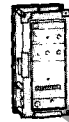

STCM2
STCM3

auxiliaries and accessories

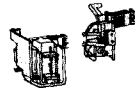

electrical auxiliaries



accessories



remote control



connection

auxiliaries and accessories



electrical auxiliaries



accessories



connection

auxiliaries and accessories



electrical auxiliaries



accessories



remote control



connection

Fupact fuse switches

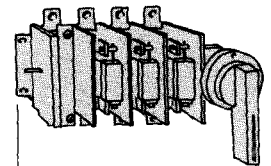

14

50

150

151

151

154

154

154

160

150

150

156

159

161

161

106

107

108

110

111

103

112

113

114

114

115

101

101

101

101

101

101

101

101

101

73

77

81

87

93

98

98

163

138 140

119 119 141

www.ElectricalPartManuals.com

Compact 11 to 1250 A

Compact system

	page
standards and description	6
various trip unit functions	10
residual current protection	12
withdrawable Compact Visucompact	13
remote control automatic source changeover	14
auxiliaries	15
accessories	
Compact UL listed circuit breakers	16

www.ElectricalPartManagers.com

Compact system presentation

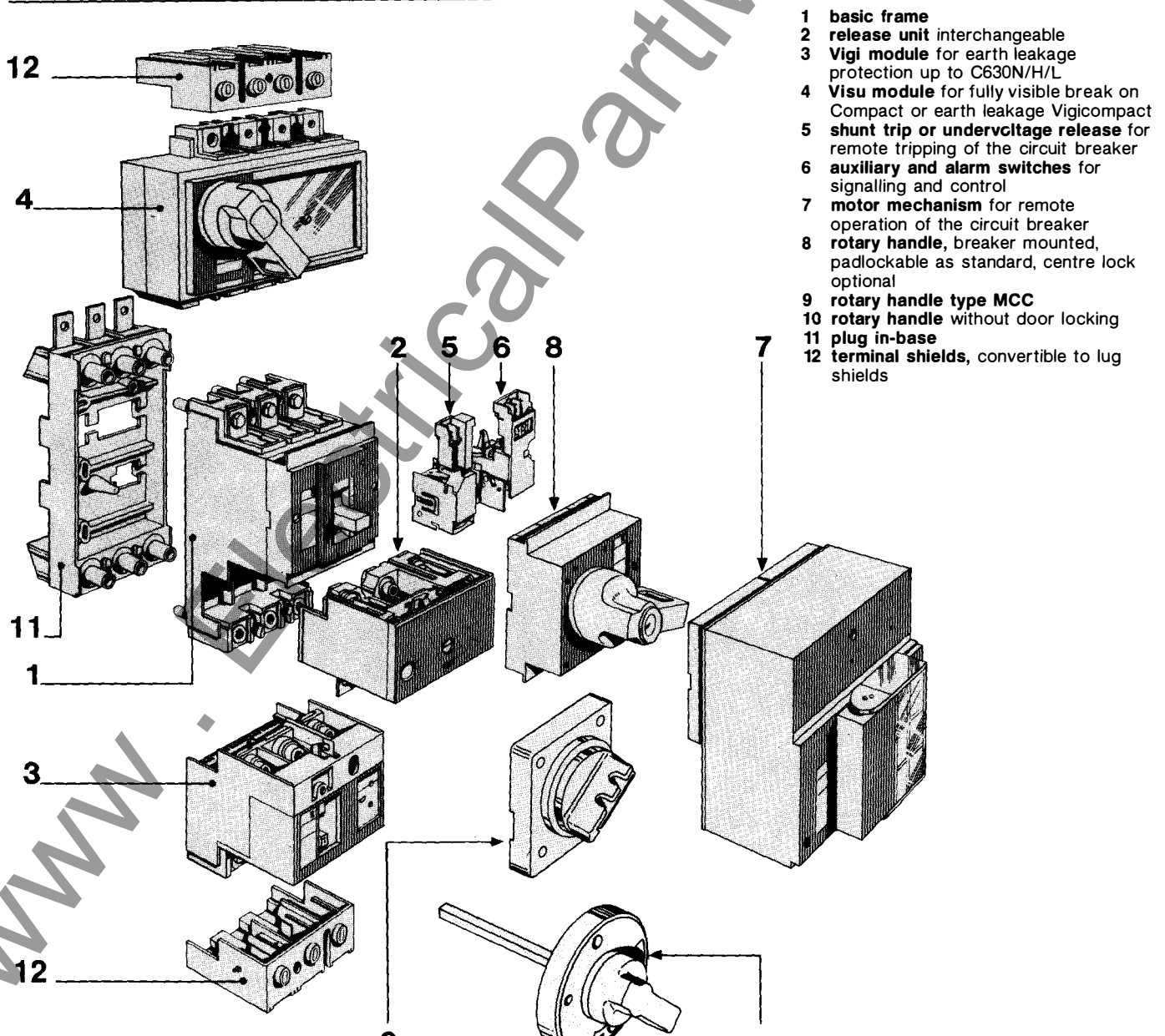
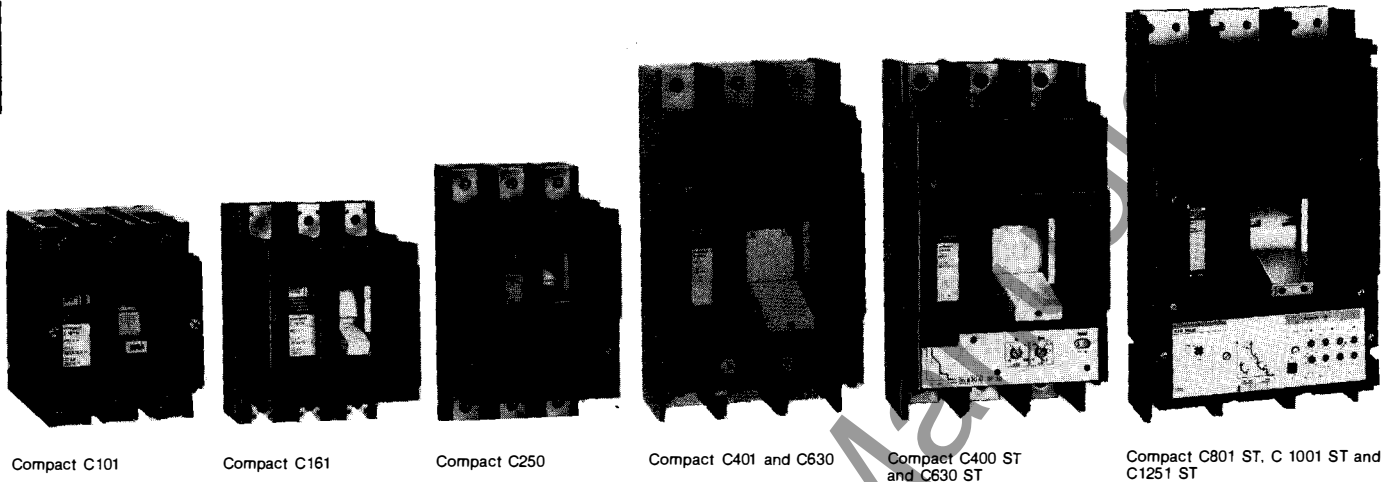

description

Compact moulded case circuit breakers come in single-pole, two-pole, three-pole and four-pole versions. Available in fixed or drawout patterns, they are designed for the control and protection of electric circuits. Compact circuit breakers are equipped with trip units providing:

- protection against overloads by adjustable thermal releases or solid state trip units (control units),
- protection against short circuits by adjustable magnetic releases or solid state trip units (control units) (fixed threshold for C101 and C161N/H/L).

4 levels of performances

Compact circuit breakers can meet 4 levels of performances:

- Compact E type (economical),
- Compact N type (standard),
- Compact H type: different from the standard Compact by its high breaking capacity,
- current limiter Compact L type with a very high breaking capacity (see table: rating and breaking capacities).

modular design

Compact circuit breakers and switches are designed as modular, easy-to-fit, bolt-on, screw-on or clip-in units for simple design and layout of electrical installations and easy modifications.

The shunt trip or undervoltage release, and the auxiliary and alarm switches are fitted inside the breaker, avoiding all risk of contact with live parts on all the Compact range.

tropicalisation

Compact and derived breakers as well as their auxiliaries are tropicalised. They meet the following standards:

IEC 68-2-30	Damp heat
IEC 68-2-2	Dry heat
IEC 68-2-11	Salt mist
IEC 68-2-1	Cold temperatures withstand.

degree of protection

(standard IEC 529).

installation and type of operating

C101/N/H/L to C1251N/HST

switchgear with terminal shields

visible handle	IP40
----------------	------

switchgear in enclosures or cubicles

visible handle	IP40
----------------	------

direct rotary handle	IP40
----------------------	------

extended rotary handle	IP55
------------------------	------

motor mechanism	IP40
-----------------	------

Compact system presentation

ratings and breaking capacities

(415/380 V - Icu according to IEC 947-2)

Stickers identify breaking capacity:

N: standard

H: high

L: very high

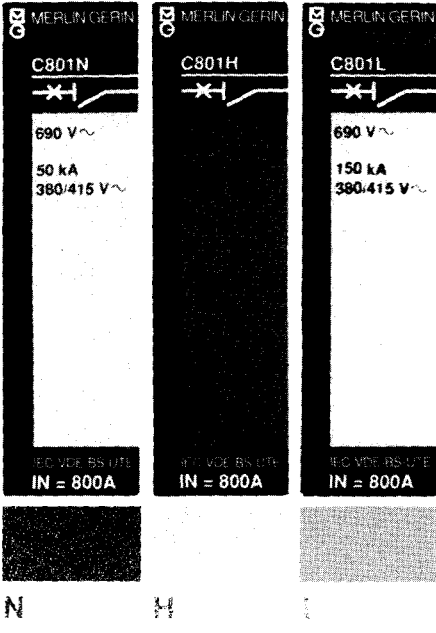

	C101H	C101L
	C161H	C161L
	C250H	C250L
	C401H	C400H ST
		C401L - C400L ST
	C630H - C630H ST	C630L - C630L ST
	C801H ST	C801L ST
	C1001H ST	C1001L ST
	C1251H ST	
		CM1250H ST
		CM1600H ST
		CM2000H ST
		CM2500H ST

standards

Merlin Gerin low voltage devices comply with all international and national standards, such as IEC, UL, JIS, CSA.

In particular, they perfectly meet the requirements of new IEC 947-2, which progressively replaces IEC 157-1.

The Merlin Gerin Compact circuit breakers are also approved for marine applications, and are recognised by the following authorities:

- Bureau Veritas (BV);
- Lloyd's Register of Shipping (LRS);
- Registro Italiano Navale (RINA);
- Germanischer Lloyd (GL);
- USSR Register of Shipping (USSR RS);
- Det Norsk Veritas (DNV);
- American Bureau of Shipping (ABS);
- Korean Register of Shipping (KRS).

IEC 947 new standards

A new series of standards for low voltage switch and controlgears: for circuit breakers, IEC 947-2.

It takes into account technical and technological progress made in the past years, as well as the real conditions of use of the breakers. The main development:

- **clarification of the notion of breaking capacity:**
 - Icu, ultimate breaking capacity: maximum assumed fault current (low likelihood),
 - Ics, breaking capacity during operation (% of Icu): smaller value of fault current, with a greater likelihood in real applications;
- **definition of two categories of devices, according to their capacity for chronometric selectivity:**
 - A category: not designed for chronometric selectivity,
 - B category: specifically designed to carry out chronometric selectivity;
- **recognition and definition of the disconnection capacity;**
- **new sequences of test, aiming at taking into account the real situations met in installations.**

maximum safety

- positive break indication: the handle position reflects the position of the main contacts;
- shock wave withstand: 8 kV (sea level);
- very low level of leakage current, checked on new devices and on devices having undergone sequences of tests representative of the "end of service life".

Those characteristics specified by IEC 947.2 ensure a major improvement of the user safety.

All Compact breakers comply with them and are therefore suitable for disconnection.

They bear the symbol "circuit breaker disconnecter" on the front cover:

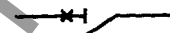

- double case insulation of front face (class II device) allowing class II installations with breaker control from outside.

Compact system presentation

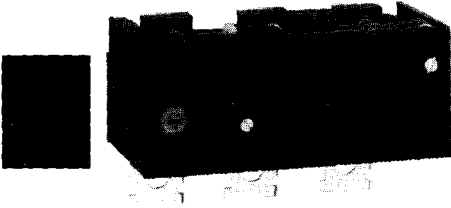

Compact breakers offer various protections, depending on their trip unit.

Two ranges of trip units, from 15 to 3200 A ratings:

- thermal magnetic trip units,
- solid state control units, offering simple protection and monitoring solutions for LV distribution networks:
- greater adjustment accuracy.

A single control unit can offer several types of protections.

- easy factory and on-site checks.
- new functions, such as load monitoring and fault indication.

thermal magnetic trip units

protection	rated current (A)									
	10	100	160	250	400	630	1 250	2 000	3 200	
standard	type D									
low threshold	type G									
short circuits with selectivity	type SA									
short circuits with SELLIM (3) system selectivity	type SB									
motors	type MA (1)									
direct current	type P (2)									

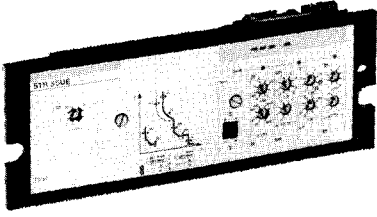

solid state control units

protection	rated current (A)									
	10	100	160	250	400	630	1 250	2 000	3 200	
standard			ST 204S	STR 25DE STR 35SE/ME STR 55UE		ST-CM1 ST-CM3				
low threshold			ST 204S	STR 35GE STR 55UE		ST-CM1 ST-CM2				
short circuits with selectivity			ST 204S	STR 35SE/ME STR 55UE		ST-CM1 ST-CM3				
short circuits with SELLIM (3) system selectivity			ST 204SB	STR 45UE						
motors				STR 35ME STR 55UE						

www.ElectricalPartManuals.com

Compact system presentation

residual current protection: Vigicomact, Compact circuit breaker with separate relay

residual current protection

Residual current protection is used to provide several important functions:

- protection of persons against indirect contact (IT, TT and TN grounding systems);
- additional protection of persons against direct contact;
- protection of equipment and property against the risk of damage or fire caused by earth fault currents.

The devices presented below are protected against inadvertent tripping.

residual current protection by an add-on module

Vigicomact

The Vigicomact is made up of a Compact C101N/H/L to C630N/H/L ST circuit breaker with one of the following types of clip-in Vigi modules:

- **REH** for the Vigicomact C101N/H/L to C250N/H/L;
- **RMM** for the Vigicomact C101N/H/L and C161N/H/L;
- **REM** for the Vigicomact C401N/H/L to C630 N/H/L ST.

The Vigi modules are interchangeable and may be fitted with lead seals.

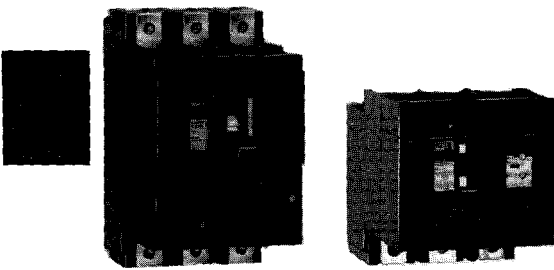

Compact



Vigi module

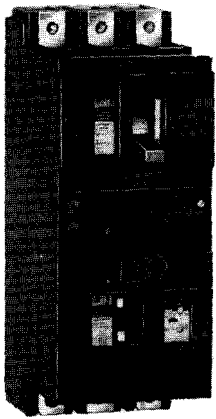

Vigicomact

residual current protection by a separate residual current relay

Compact with Vigirex and separate toroid type sensor

This type of residual current protection can be implemented on all Compact circuit breakers from C101 N/H/L to C1251 N/H ST and on Compact type NI load break switches.

It consists of:

- a Compact circuit breaker or load break switch;
- a voltage release;
- a separate Vigirex residual current relay;
- a separate toroid type sensor.

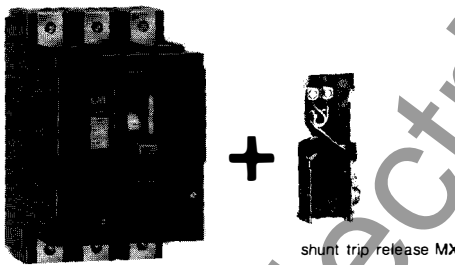

Compact C250N



shunt trip release MX

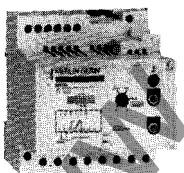

Vigirex RH50

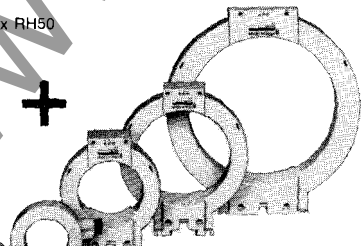

withdrawable Compact Visucompact circuit breaker for the fully visible break

withdrawability

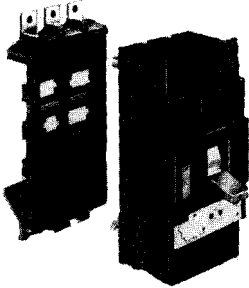

plug-in Compact base

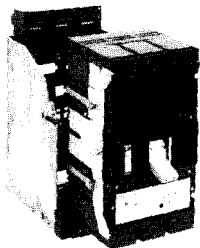

universal chassis

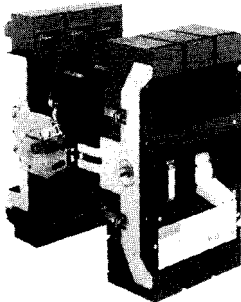

standard chassis (C1251)

withdrawable Compact

The withdrawable function allows:

- removal of circuit breaker without touching live parts;
- fast interchanging of devices;
- prewiring of extra fixed parts ready for easy fitting of the moving portion when additional outgoing circuits become necessary.

All withdrawable Compact circuit breakers come with an automatic tripping device eliminating all danger of on-load withdrawal. The auxiliary circuits are disconnected at the same times as the power circuits.

C101N/H/L to C630N/H/L ST can be made withdrawable by adding:

- either a set of connecting pins and a plug-in base;
- or a drawout chassis⁽¹⁾.

C801N/H/L ST to C1251N/H ST can be supplied with:

- universal chassis, meeting all the requirements for incoming breakers:
 - through door drawing in and out,
 - through door closing and opening of the breaker;
- standard chassis:
 - drawing in and out with door open
 - through door opening and closing of the breaker.

⁽¹⁾ except for C101.

fully visible break

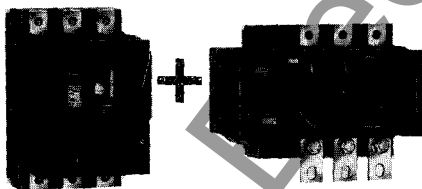

Compact

Visu module

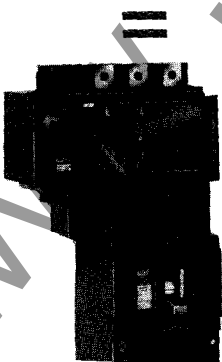

Visucompact

Fully visible break requires visual evidence of isolation between supply and load circuits (safety of persons). This function is provided by Visucompact circuit breakers, in two versions:

- fixed Visucompact, from C161N to C1251N ST, comprising:
 - a fixed Compact circuit breaker,
 - a Visu module, which can be locked in "OFF" position (padlock or keylock). The Visu module provides the fully visible break indication;
- drawout Visucompact C801N ST to C1251N ST, comprising:
 - a fixed part (Compact of the considered rating) with safety shutters preventing access to the power contacts and a "disconnected position" padlocking device,
 - a universal chassis.

Compact system presentation

remote control automatic source changeover

remote control

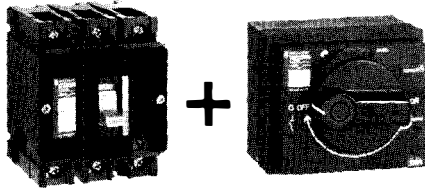

Compact

motor mechanism

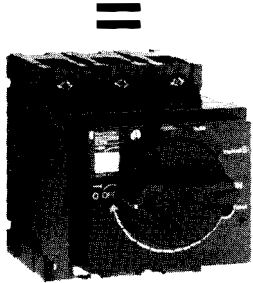

motorised Compact

Remote control allows remote opening and closing of the breaker, positive break indication being maintained:

It can act:

- on orders from push-buttons, switches, relays, programmable controller (1)...

- locally by action on the mechanical devices on front of the breaker.

From C101N/H/L to C1251N/H ST, remote control is achieved by an adaptable motor mechanism, easily fitted on the front of the Compact circuit breaker:

- T type (C101N/H/L to C1251N/H ST) enables:

- daily opening and closing of a circuit from a control desk,
- load shedding, restoring on non priority circuits,
- automatic source changeover;

- TS type (C161N/H/L to C1251N/H ST) offering, in addition of T type function, the possibility of performing high speed closing for synchrocoupling operations.

For the Compact C101 to C1251N/H/L the T and TS(2) type motor mechanism:

- are equipped with a padlockable toggle, (padlock hasp $\varnothing 6$ to 9 mm).

The toggle, which indicates the 3 circuit breaker positions, enables manual resetting. This control can, on option, be locked by 1 Ronis or Profalux keylock (except on the source changeovers).

- can be associated with an SDE(2) contact to perform remote resetting, after opening by MX or MN voltage release. If tripping due to an overcurrent or insulation fault (with Vigi module) occurs, manual resetting is compulsory in all cases on the circuit breaker (no remote resetting).

Auxiliaries

The Compact circuit breakers equipped with a motor mechanism can be fitted with the same auxiliaries as the manually controlled circuit breaker.

(1) through a low level interface.

(2) except for C101 and C161.

automatic source changeover

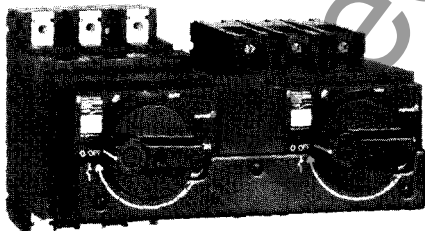

C250 to C1251N/H/L

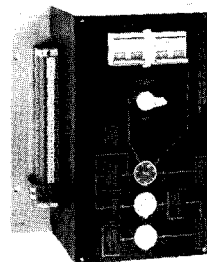

automatism

The automatic source changeovers of the Compact range are composed of:

- a base plate

- 2 Compact (circuit breakers or switch) rating 15 to 1250 A with mechanical and electrical interlock.

These breakers can be:

- the same,
- different with respect to type rating or trip unit

- 2 type motor mechanism (1 per breaker);

- an automatism plate in one single piece with terminal block for external connections.

remote indications
remote tripping

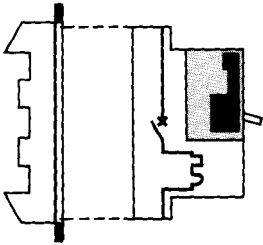

2 OF block

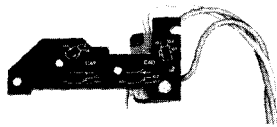

CAM block

front operation

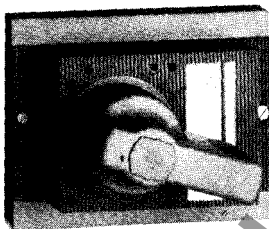

Direct rotary handle

installation

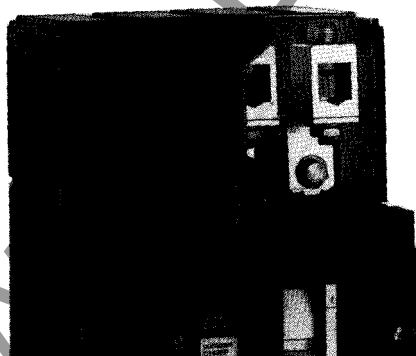

auxiliary switches,
voltage releases

A range of auxiliary contacts, shunt trips and undervoltage releases equips all Compact circuit breakers and their derived products. These auxiliaries are fitted inside the circuit breaker without any difficulty. Regarding particularly the Compact C100E to C600E and C101N/H/L to C1251N/H ST, they are simply clipped in without any risk of contact with the live parts.

standard auxiliaries

- **OF contact double throw switch**
Used for a signal or a control linked with the "OFF" or "ON" position.
- **SD contact double-throw switch**
Used for indication when the breaker opens on any fault (overload, short circuit, earth leakage, tripping by MX or MN).
- **SDE contact**
Used for indication when the breaker opens on an electrical fault (overload, short circuit or earth leakage).
- **MX voltage release** for shunt tripping;
- **instantaneous or delayed MN voltage release** for undervoltage tripping.

standard auxiliaries

For Visu module or rotary operating handle

- **CAM early break contact** with advanced action before the operation of the main contacts of the switch (opening or closing depending on the way the contact is fitted). Generally used to initiate an early break on downstream devices.

rotary handle

Compact C101N/H/L to C1251N/H ST circuit breakers can be equipped with rotary handles:

- **standard direct rotary handle**;
- **type MCC direct rotary handle**, for Compact C101N/H/L to C250N/H/L.
- **extended rotary handle with door locking** when circuit breaker is in "ON" position; available with short or long extension shaft;
- **extended rotary handle without door locking**, with short extension shaft.

A large range of accessories is available for easy installation and operation of Compact circuit breakers.

Sealing accessories for tamperproofing of Compact cover, terminal shields and settings.

Label holders, adaptable to the front face of Compact circuit breakers for identification purposes.

Door cut-out grommet designed to cover the perimeter of the door cut-out for the handle, making a precise door cut-out unnecessary.

Tight bellows designed to seal the handle passage through the door.

Locator designed to prevent the moving part of a Compact N or H from being plugged into the base of a Compact L.

Terminal shields designed to prevent direct contact with live connection parts.

Compact system presentation

Compact circuit breaker
UL listed

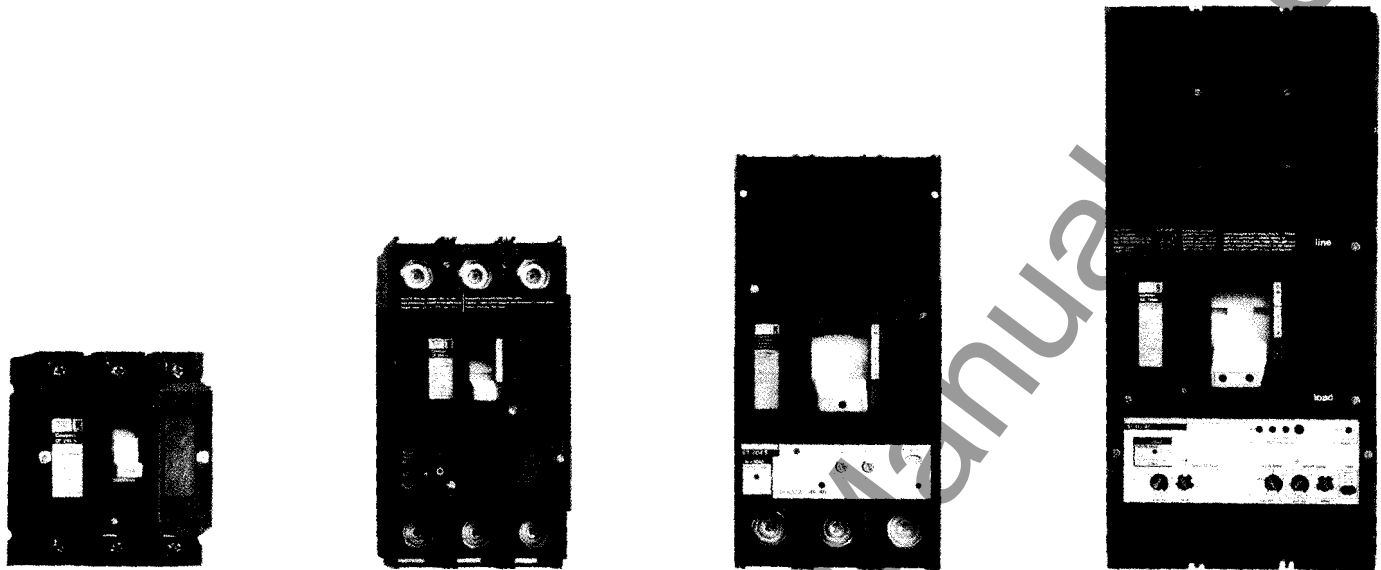

CK 800 N

breaking capacity

- N:** normal
- H:** high breaking
- L:** current limiting

Note all circuit breakers from CE to CM range are standard rated, except for:

- CK: type NN & HH
- CM: type NN which are 100% rated.

max rating

frame size

- CM:** 3000 A 3-pole
 - CK:** 1200 A 3-pole
 - CJ:** 600 A 3-pole
 - CF:** 250 A 2-pole and 3-pole
 - CE:** 100 A 1-pole, 2-pole, 3-pole
- 480 V: CE 104
600 V: CE 106

Approvals for North America

Specifications for low voltage circuit breakers in the USA and CANADA are very different from those in most other industrialised countries and stipulate special approvals for all devices. The necessary approval is delivered by Underwriters Laboratories in the USA (indicated by the UL mark) and by the Canadian Standards Association in Canada (CSA Mark).

The Compact UL range

The UL range includes devices rated from 15 to 3000 A and offers three breaking capacity levels. It differs from the IEC range by:

- device designations: see opposite;
- performance indications based on American voltages, e.g. 600 V 60 Hz. See table opposite;
- cable connectors complying with UL 486 B for copper and aluminium cables;
- rating plug on solid state trip units: American standards forbid the use of a circuit breaker for which the long time setting could be adjusted to a value exceeding the thermal withstand of the cables or busbars. To meet this requirement, it is necessary either to offer a large number of different ratings or a basic breaker with rating plugs determining the maximum setting value. Consult us for appropriate documentation.

www.ElectricalWorld.com

Compact 11 to 1 250 A

2 characteristics

	page
mccb's selection table of	
Compact C100E to C600E	19
Compact C100NF to C1251N ST	20
Compact C101H to C1251H ST	22
Compact C101L to C1001L ST	24
cascading	26
thermal magnetic trip unit selection	32
solid state trip unit selection	36
Vigicompact selection	42
remote control selection	44
automatic source changeover	50
auxiliaries	54
accessories	57
installation	61

www.ElectricalPartMarket.com



www.ElectricalPartManuals.com

characteristics

selection table: circuit breakers

com

economical range (type E)		Compact with thermal magnetic trip unit									
		Compact		C100E		C225E		C400E		C600E	
electrical characteristics											
rated current In (A)	40 °C	100	225	400	600						
	50 °C	95	213	380	560						
rated insulation voltage Ui (V)	60 °C	90	200	360	520						
		500	500	500	500						
rated operational voltage Ue (V)	AC 50/60 Hz	500	500	500	500						
	DC										
number of poles		3	3	3	3						
rated ultimate breaking capacity	200/240 V	25	25	30	30						
	AC Icu (kA rms) ⁽¹⁾ according to IEC 947.2	10	10	22	22						
(P1 according to IEC 157-1)	440 V	8	8	18	18						
	500 V										
rated ultimate breaking capacity	660/690 V										
	DC < 250 V										
Icu (kA) according to IEC 947.2 ⁽²⁾	500 V										
rated service breaking performances Ics (% of Icu)		50 %	50 %	50 %	50 %						
utilisation category											
rated admissible short time withstand current Icw	kA (rms)										
	t (s)										
disconnecter circuit breaker		■	■	■	■						
front face insulation class II		■	■	■	■						
rated impulse withstand voltage Uimp (kV)		8	8	8	8						
pollution degree		III	III	III	III						
safety perimeter		see schema page 63									
performance according to Nema	240 V	25	25	30	30						
	480 V	8	8	18	18						
rated breaking capacity AB1 (O-CO) according to Nema	600 V										
trip units	interchangeable										
	built-in	■	■	■	■						
thermal magnetic	type D	■	■	■	■						
	type G (generator protection)										
	type SA (selective)										
	type SB (selective Sellim)										
	type P (for direct current)										
	type MA (motor protection)										
solid state	type ST 204 S										
	type ST 204 SB										
	type STR 25 DE										
	type STR 35 GE/SE/ME										
	type STR 55 UE										
	type STR 45 BE										
models	Vigicompact (ELCB)										
	Visucompact (visible break CB)										
	automatic source changeover										
	manual source changeover										
auxiliaries	Compact switch type NI										
	auxiliary switch (OF, CAM)	■	■	■	■						
	alarm switch (SD, SDE)	■	■	■	■						
	shunt trip (MX); undervoltage release (MN)	■	■	■	■						
accessories	motor mechanism (T, TS)										
	terminal shields	■	■	■	■						
	connection accessories	■	■	■	■						
	padlocking device locking devices	■	■	■	■						
installation	rotary handles										
	versions front or rear connected	FC	RC	FC	RC	FC	RC	FC	RC		
	fixed	■	■	■	■						

WWW

www.artman.com

characteristics

selection table: circuit breakers (continued)

standard range (type N)		Compact with thermal magnetic trip unit							
Compact		C100NF		C101N		C161N		C250N	
electrical characteristics									
rated current I _n (A)	40 °C	100		100		160		250	
	50 °C	95		95		150		235	
	60 °C	90		90		140		220	
rated insulation voltage U _i (V)		690		690		690		690	
rated operational voltage U _e (V)	AC 50/60 Hz	277		690		690		690	
	DC			500		500		500	
number of poles		1		2, 3, 4		2, 3, 4		2, 3, 4	
rated ultimate breaking capacity	220/240 V	15 (14 at 277 V)		85		85		85	
	AC I _{cu} (kA rms) ⁽¹⁾ according to IEC 947.2	380/415 V		25		25		35	
	440 V	20		20		22		30	
	(P1 according to IEC 157-1)	500 V		14		14		15	
rated ultimate breaking capacity	DC < 250 V (2p)			25		35		50	
	I _{cu} (kA) according to IEC 947.2 ⁽²⁾	500 V (4p)		25		35		50	
rated service breaking performances I _{cs} (% of I _{cu})		50 %		50 %		50 %		50 %	
utilisation category		A		A		A		A	
rated admissible short time withstand current I _{cs}	kA (rms)								
disconnector circuit breaker	t (s)								
front face insulation class II		■		■		■		■	
rated impulse withstand voltage U _{imp} (kV)		8		8		8		8	
pollution degree		III		III		III		III	
safety perimeter		see schema page 63							
performance according to Nema	rated breaking capacity (O-CO)	240 V		15-14 at 277 V		85		85	
	according to Nema AB1	480 V		20		22		30	
		600 V		10		10		12	
trip units	interchangeable							■	
thermal magnetic	built-in	■		■		■		■	
	type D	■		■		■		■	
	type G (generator protection)			■		■		■	
	type SA (selective)							■	
	type SB (selective Selim)								
	type MA (motor protection)							■	
solid state	type P (for direct current)								
	type ST 204 S								
	type ST 240 SB								
	type STR 25 DE								
	type STR 35 GE/SE/ME								
	type STR 55 UE								
options	type STR 45 BE								
	fault indication								
	ground fault protection								
	load shedding								
models	communication								
	Vigicomact (ELCB)			■		■		■	
	Visucompact (visible break CB)					■		■	
	automatic / manual source changeover			■		■		■	
	Compact switch type NI			■		■		■	
auxiliaries	auxiliary switch (OF, CAM) / alarm switch (SD, SDE)			■		■		■	
	MX, MN, motor mechanism (T, TS)			■ (3)		■		■	
accessories	terminal shields			■		■		■	
	connection accessories	■ built-in		■ built-in		■		■	
	padlocking device / locking devices	■		■		■		■	
	rotary handles			■		■		■	
installation	versions front or rear connected	FC	RC	FC	RC	FC	RC	FC	RC
	fixed	■		■		■		■	
	plug-in			■		■		■	

characteristics

selection table: circuit breakers (continued)

high breaking capacity (type H)

Compact with thermal magnetic trip unit

Compact		C101H	C161H	C250H	C401H	
electrical characteristics						
rated current I _n (A)	40 °C	100	160	250	400	
	50 °C	95	150	235	380	
	60 °C	90	140	220	360	
rated insulation voltage U _i (V)		690	690	690	690	
rated operational voltage U _e (V)	AC 50/60 Hz	690	690	690	690	
	DC	500	500	500	500	
number of poles		3, 4	3, 4	3, 4	3, 4	
rated ultimate breaking capacity	220/240 V	100	100	100	100	
	AC I _{cu} (kA rms) ⁽¹⁾ according to IEC 947.2	380/415 V	65	50	65	50
rated service breaking performances I _{cs} (% of I _{cu}) (P1 according to IEC 157-1)	440 V	42	35	42	42	
	500 V	25 ⁽⁴⁾	14	18	18	
	660/690 V	10	10	10	12	
	DC < 250 V (2p)	50	50	85	85	
rated ultimate breaking capacity I _{cu} (kA) according to IEC 947.2 ⁽²⁾	500 V (4p)	50	50	85	85	
	rated service breaking performances I _{cs} (% of I _{cu})	50 %	25 %	50 %	50 %	
utilisation category		A	A	A	A	
rated admissible short time	kA (rms)					
withstand current I_{cw}	t (s)					
disconnecter circuit breaker		■	■	■	■	
front face insulation class II		■	■	■	■	
rated impulse withstand voltage	U _{imp} (kV)	8	8	8	8	
pollution degree		III	III	III	III	
safety perimeter		see schema page 63				
performance according to Nema	rated breaking capacity (O-CO)	240 V	100	100	100	100
	according to Nema AB1	480 V	42	35	42	42
		600 V	14	10	14	14
trip units	interchangeable					
	built-in	■	■	■	■	
	type D	■	■	■	■	
	type G (generator protection)	(3)	(3)	■	■	
	type SA (selective)		■	■	■	
	type SB (selective Sellim)			■	■	
thermal magnetic	type MA (motor protection)	■	■	■	■	
	type P (for direct current)				■	
	solid state					
	type ST 204 S					
type ST 204 SB						
type STR 25 DE						
type STR 35 GE/SE/ME						
type STR 55 UE						
type STR 45 BE						
options	fault indication					
	ground fault protection					
	load shedding					
	communication					
models	Vigicompact (ELCB)	■	■	■	■	
	Visucompact (visible break CB)					
	automatic / manual source changeover	■	■	■	■	
	Compact switch type NI					
auxiliaries	auxiliary switch (OF, CAM) / alarm switch (SD, SDE)	■	■	■	■	
	MX, MN, motor mechanism (T, TS)	■ (6)	■	■	■	
accessories	terminal shields	■	■	■	■	
	connection accessories	■ built-in	■	■	■	
	padlocking device / locking devices	■	■	■	■	
	rotary handles	■	■	■	■	
installation	versions front or rear connected	FC RC	FC RC	FC RC	FC RC	
	fixed	■ ■	■ ■	■ ■	■ ■	
	plug-in	■ ■	■ ■	■ ■	■ ■	

(1) defined for a power factor of:
 0.5 if 6 < kA rms < 10
 0.3 if 10 < kA rms < 20
 0.25 if 20 < kA rms < 50
 0.2 if kA rms > 50

(2) L/R ≤ 0.015 s

(3) consult us

(4) 15 kA for 15 A rating

(5) withdrawable version

(6) consult us

characteristics

selection table: circuit breakers (continued)

very high breaking capacity
(type L)

Compact with thermal magnetic trip unit



Compact

C101L

C161L

C250L

C401L

electrical characteristics

rated current I_n (A)	40 °C	100	150	235	350
	50 °C	95	140	223	325
	60 °C	90	130	211	300
rated insulation voltage U_i (V)		690	690	690	690
rated operational voltage U_e (V)	AC 50/60 Hz	690	690	690	690
	DC	500	500	500	500
number of poles		3, 4	3, 4	3, 4	3, 4
rated ultimate breaking capacity	220/240 V	150	150	150	150
AC I_{cu} (kA rms) ⁽¹⁾ according to IEC 947.2	380/415 V	150	150	150	150
	440 V	125	150	150	150
(P1 according to IEC 157-1)	500 V	100	100	100	100
	660/690 V	50	50	50	50
rated ultimate breaking capacity	DC < 250 V (2p)	100	100	100	100
I_{cu} (kA) according to IEC 947.2 ⁽²⁾	500 V ^(4p)	100	100	100	100
rated service breaking performances I_{cs} (% of I_{cu})		50 %			
utilisation category		A	A	A	A
rated admissible short time withstand current I_{cw}	kA (rms)				
disconnector circuit breaker	t (s)				
front face insulation class II					
rated impulse withstand voltage	U_{imp} (kV)	8	8	8	8
pollution degree		III	III	III	III
safety perimeter		see schema page 63			
performance according to Nema	rated breaking capacity (O-CO)	240 V	150	150	150
	according to Nema AB1	480 V	125	150	150
		600 V	50	50	65
trip units	interchangeable				
	built-in				
thermal magnetic	type D				
	type G (generator protection)	(3)	(3)		
	type SA (selective)				
	type SB (selective Sellim)				
	type MA (motor protection)				
	type P (for direct current)				
solid state	type ST 204 S				
	type ST 240 SB				
	type STR 25 DE				
	type STR 35 GE/SE/ME				
	type STR 55 UE				
	type STR 45 BE				
options	fault indication				
	ground fault protection				
	load shedding				
	communication				
models	Vigicompact (ELCB)				
	Visucompact (visible break CB)				
	automatic / manual source changeover				
	Compact switch type NI				
auxiliaries	auxiliary switch (OF, CAM) / alarm switch (SD, SDE)				
	MX, MN, motor mechanism (T, TS)				
accessories	terminal shields				
	connection accessories				
	padlocking device / locking devices				
	rotary handles				
installation	versions front or rear connected	FC	RC	FC	RC
	fixed				
	plug-in				

(1) defined for a power factor of:
 0.5 if $6 < kA_{rms} \leq 10$
 0.3 if $10 < kA_{rms} \leq 20$
 0.25 if $20 < kA_{rms} \leq 50$
 0.2 if $kA_{rms} > 50$
 (2) $L/R \leq 0.015$ s
 (3) consult us
 (4) withdrawable version

characteristics cascading according to IEC 947-2

220/240 V network
upstream:
downstream:
Multi 9 and Compact

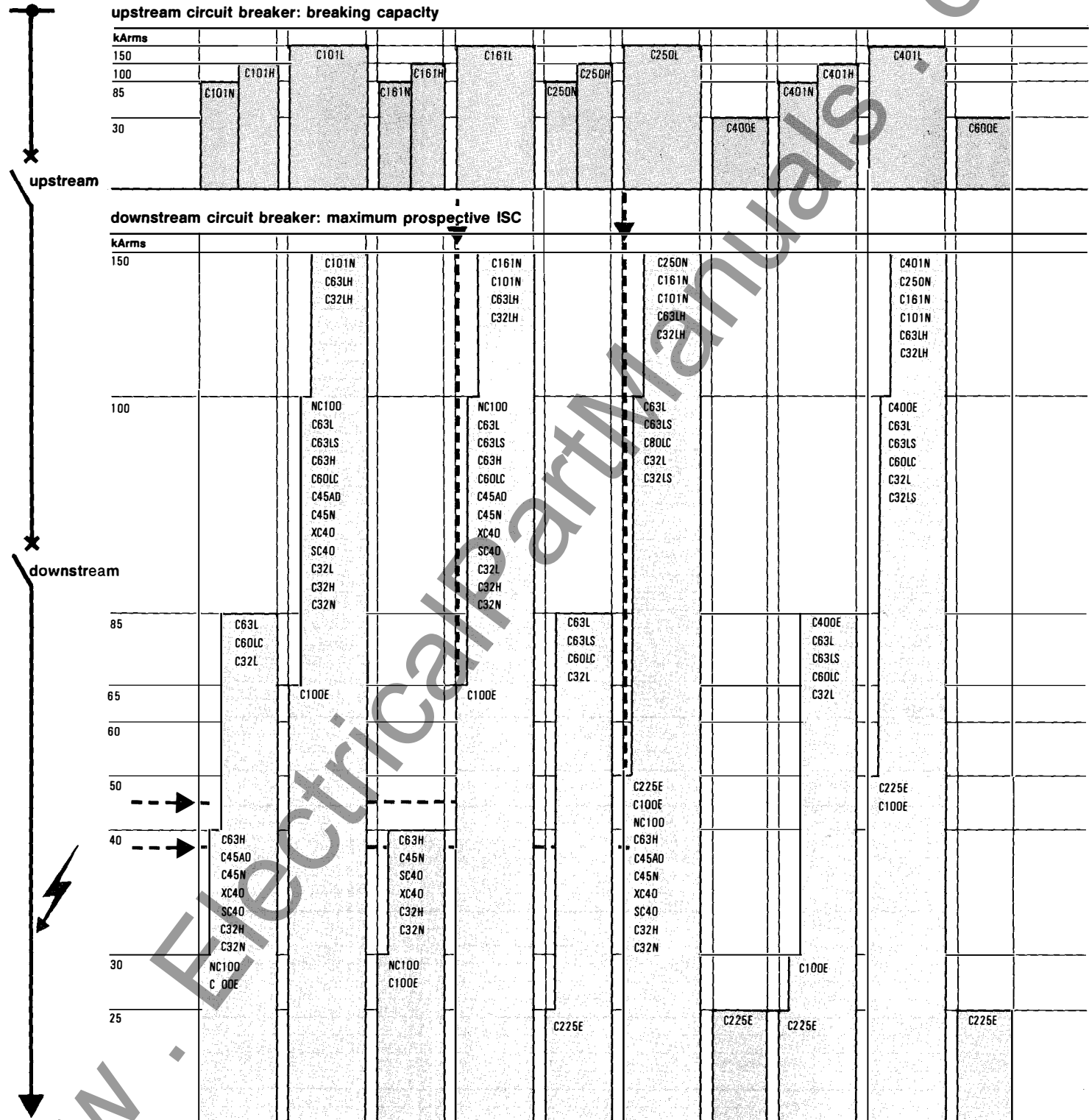

Example: 220/240 V network

Note: For clarity, the C400N, H or L ST and the C630N, H or L ST have been omitted from the above bar graphs since their cascading characteristics are identical to these of the C401N, H or L and the C630N, H or L respectively.

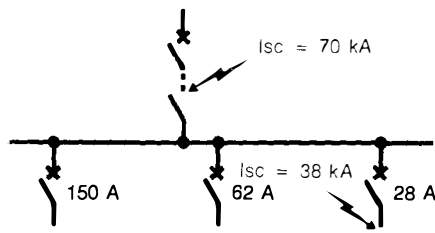

By installing a C250L circuit breaker (breaking capacity 150 kA) at the upstream end of the installation, and with an I_{sc} of 38 kA on the busbars, it is possible to install a C32N circuit breaker (breaking capacity 16 or 12 kA depending on the curve) on the 28 A outgoing line, a NC100 circuit breaker (breaking capacity 15 or 12 kA depending on the curve) on the 62 A outgoing line and a C161N circuit breaker (breaking capacity 85 kA)

kArms	C630L		C801H		C801L		C1001H		C1001L		C1251H		CN Masterpact
150													
100	C630N	C630H											
85			C801N				C1001N						
30													
kArms													
150		C630N C401N C250N C161N C101N			C801N C630N C401N C250N C161N				C1001N C801N C630N C401N C250N C161N C101N				
100		C600E C400E		C801N C630N C401N C250N C161N	C600E C400E			C1001N C801N C630N C401N C250N C161N C101N	C600E C400E			C1251N C1001N C801N C630N C401N C250N C161N C101N	C1251N C1001N C801N C630H C401H
85	C600E C400E		C600E C400E	C600E C400E			C600E C400E	C600E C400E		C600E C400E		C600E C400E	
65													
60						C100E				C100E			
50		C225E C100E											
40													
30	C100E						C225E C100E	C225E C100E			C225E C100E	C225E C100E	
25	C225E		C225E C100E	C225E C100E									

Example: 380 V network (3P + N) with three-phase and single-phase (phase + neutral) outgoing lines.

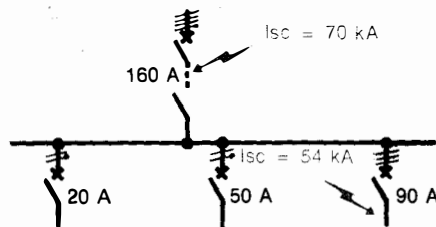

By installing a 4-pole C161L circuit breaker (breaking capacity 150 kA) at the upstream end of the installation, and with an I_{sc} of 54 kA on the busbars, it is possible (see pages 28 and 29) to install a 3-pole C100E circuit breaker on the 90 A outgoing line (see above table for single-phase outgoers), a 2-pole C63H circuit breaker (breaking capacity 12 kA) on the 50 A outgoing line and a C32N circuit breaker (breaking capacity 16 or 12 kA depending on the curve) on the 20 A

characteristics cascading (continued) according to IEC 947-2

380/415 V network⁽¹⁾
 upstream:
 downstream:
 Multi 9 and Compact

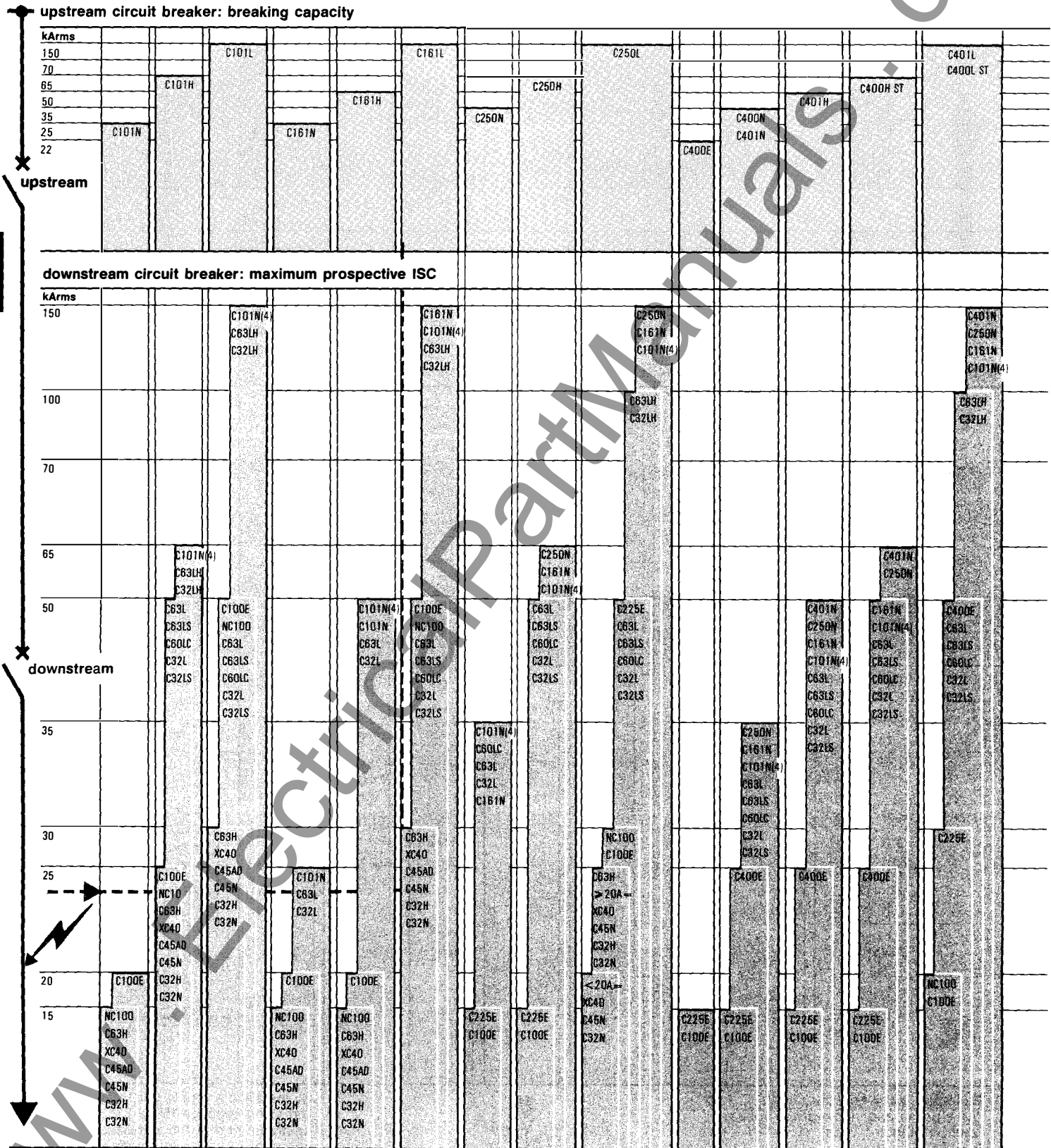

Example: 380 V network

Note: For clarity, the C630N, H or L ST have been omitted from the above bar graphs since their cascading characteristics are identical to these of the C630N H or L respectively.

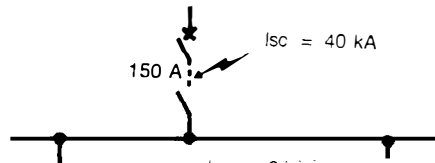

By installing a C161L circuit breaker (breaking capacity 150 kA) at the upstream end of the installation, and with an Isc of 24 kA on the busbars, it is possible to install a C32N circuit breaker (breaking

characteristics cascading according to IEC 947-2

44
upst.
Compact
downstr.
Compact

www.electricalpartsmagazine.com

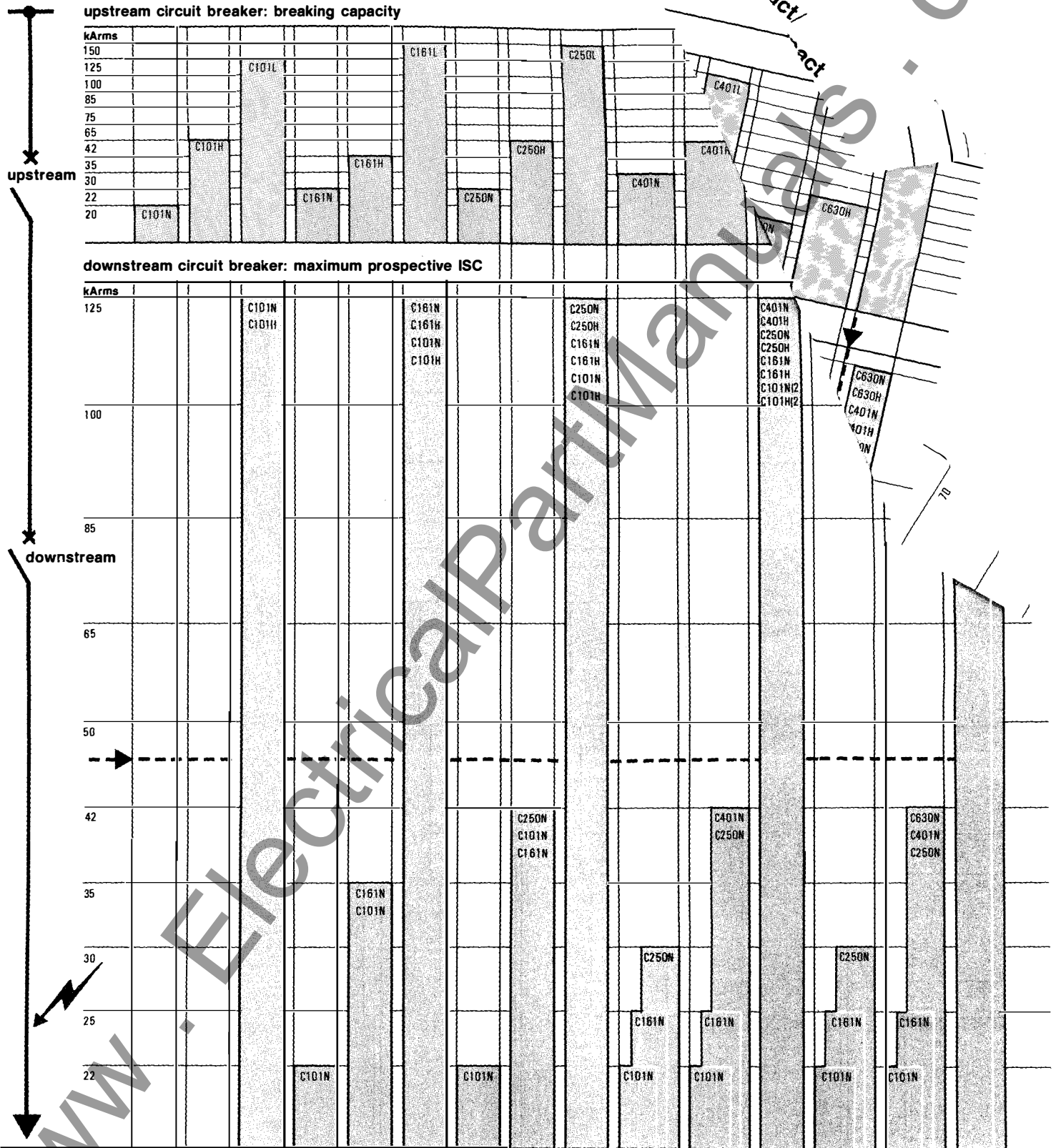

Example: 440 V network

Note: For clarity, the C400N, H or L ST and the C630N, H or L ST have been omitted from the above bar graphs since their cascading characteristics are

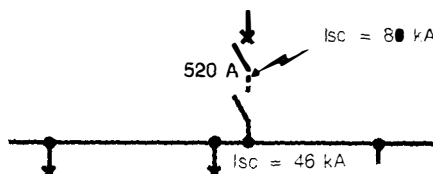

By installing a C630L circuit breaker (breaking capacity 150 kA) at the upstream end of the installation, and with an Isc of 48 kA on the busbars, it is possible to install

kArms														
150														
125														
100			C801L				C1001L							MP H2
85													CM-H	
75														MP H1
65		C801N	C801H				C1001H						CM-N	
42						C1001N				C1251N		C1251H		
35														
30														
22														
20														
125														
100				C801N C801H C630N C630H C401N C401H			C1001N C1001H C801N C801H C630N C630H C401N C401H							
85				C250N C250H			C250N C250H						CM-N	
65				C1001N C801N			C1001N C801N			C1251N C1001N C801N	C1251N C1001N C801N	C1251N C1001N C801N	C1251N C1001N C801N	C1251N C1001N C801N
50				C630H C401H	C161N C161H C101N(2) C101H(2)		C630H C401H	C161N C161H C101N(2) C101H(2)		C630H C401H				
42		C630N C401N	C630N C401N			C630N C401N	C630N C401N			C630N C401N	C630N C401N		C630N C401N	
35														
30														
25	C250N	C250N				C250N	C250N			C250N	C250N			
22														

www.ElectricalPartManuals.com

characteristics selection table: thermal magnetic trip units

for Compact		C100E	C225E	C400E	C600E
release unit	interchangeable built-in	■	■	■	■
standard trip unit					
type D thermal magnetic	thermal Ir (A) continuous current setting	fixed threshold rating Ir at: 40°C 50°C 60°C	fixed threshold rating Ir at: 40°C 50°C 60°C	fixed threshold rating Ir at: 40°C 50°C 60°C	fixed threshold rating Ir at: 40°C 50°C 60°C
		15 15 14 14 20 20 19 18 30 30 29 27 40 40 38 36 50 50 48 45 60 60 57 54 80 80 76 72 100 100 95 90	125 125 117 109 150 150 142 132 175 175 165 155 200 200 187 172 225 225 213 200	250 250 236 221 300 300 285 269 350 350 326 300 400 400 380 360	500 500 470 440 600 600 560 516
	magnetic I _{rm} (A) min. and max. threshold 2 poles loaded	fixed threshold rating I _{rm}	fixed threshold rating I _{rm}	fixed threshold rating I _{rm}	fixed threshold rating I _{rm}
		15 130 20 160 30 240 40 320 50 400 60 500 80 640 100 800	125 875 150 1050 175 1750 200 2000 225 2250	250 2500 300 3000 350 3500 400 4000	500 5000 600 6000
other trip units					
type G low magnetic release	thermal magnetic I _{rm} (A) max. and min. threshold 2 poles loaded				
type SA selective release	thermal magnetic I _{rm} (A)				
	instantaneous protect. I (A)				
type SB Sellim selective release (full discrimination with all downstream breaker)	thermal magnetic I _{rm} (A)				
type MA magnetic release only	thermal magnetic I _{max} (A) maximum continuous current at 65 °C I _{rm} (A) max. and min. threshold 2 poles loaded				

characteristics selection table: thermal magnetic trip units (continued)

for Compact		C250N C250H	C250L																																															
release unit	interchangeable built-in	■	■																																															
standard trip units																																																		
type D thermal-magnetic 	thermal	adj. 0.7 to 1 × I _r	adj. 0.7 to 1 × I _r																																															
	I _r (A) continuous current setting	<table border="1"> <thead> <tr> <th>rating</th> <th>I_r at:</th> <th>N/2</th> <th></th> </tr> <tr> <td></td> <td>40 °C</td> <td>50 °C</td> <td>60 °C (A)</td> </tr> </thead> <tbody> <tr> <td>D125</td> <td>125</td> <td>120</td> <td>115</td> </tr> <tr> <td>D160</td> <td>160</td> <td>152</td> <td>144</td> </tr> <tr> <td>D200</td> <td>200</td> <td>190</td> <td>180</td> </tr> <tr> <td>D250</td> <td>250</td> <td>235</td> <td>220</td> </tr> </tbody> </table>	rating	I _r at:	N/2			40 °C	50 °C	60 °C (A)	D125	125	120	115	D160	160	152	144	D200	200	190	180	D250	250	235	220	<table border="1"> <thead> <tr> <th>rating</th> <th>I_r at:</th> <th>N/2</th> <th></th> </tr> <tr> <td></td> <td>40 °C</td> <td>50 °C</td> <td>60 °C (A)</td> </tr> </thead> <tbody> <tr> <td>D125</td> <td>125</td> <td>120</td> <td>115</td> </tr> <tr> <td>D160</td> <td>160</td> <td>152</td> <td>144</td> </tr> <tr> <td>D200</td> <td>200</td> <td>190</td> <td>180</td> </tr> <tr> <td>D250</td> <td>235</td> <td>223</td> <td>211</td> </tr> </tbody> </table>	rating	I _r at:	N/2			40 °C	50 °C	60 °C (A)	D125	125	120	115	D160	160	152	144	D200	200	190	180	D250	235	223
rating	I _r at:	N/2																																																
	40 °C	50 °C	60 °C (A)																																															
D125	125	120	115																																															
D160	160	152	144																																															
D200	200	190	180																																															
D250	250	235	220																																															
rating	I _r at:	N/2																																																
	40 °C	50 °C	60 °C (A)																																															
D125	125	120	115																																															
D160	160	152	144																																															
D200	200	190	180																																															
D250	235	223	211																																															
	magnetic	adjustable	adjustable																																															
	I _{rm} (A) min. and max. threshold 2 poles loaded	<table border="1"> <thead> <tr> <th>rating</th> <th>I_{rm}</th> </tr> </thead> <tbody> <tr> <td>D125</td> <td>625 to 1250</td> </tr> <tr> <td>D160</td> <td>800 to 1600</td> </tr> <tr> <td>D200</td> <td>1000 to 2000</td> </tr> <tr> <td>D250</td> <td>1250 to 2500</td> </tr> </tbody> </table>	rating	I _{rm}	D125	625 to 1250	D160	800 to 1600	D200	1000 to 2000	D250	1250 to 2500	<table border="1"> <thead> <tr> <th>rating</th> <th>I_{rm}</th> </tr> </thead> <tbody> <tr> <td>D125</td> <td>625 to 1250</td> </tr> <tr> <td>D160</td> <td>800 to 1600</td> </tr> <tr> <td>D200</td> <td>1000 to 2000</td> </tr> <tr> <td>D250</td> <td>1250 to 2500</td> </tr> </tbody> </table>	rating	I _{rm}	D125	625 to 1250	D160	800 to 1600	D200	1000 to 2000	D250	1250 to 2500																											
rating	I _{rm}																																																	
D125	625 to 1250																																																	
D160	800 to 1600																																																	
D200	1000 to 2000																																																	
D250	1250 to 2500																																																	
rating	I _{rm}																																																	
D125	625 to 1250																																																	
D160	800 to 1600																																																	
D200	1000 to 2000																																																	
D250	1250 to 2500																																																	
other trip units																																																		
type G low magnetic release	thermal	same as D type	same as D type																																															
	magnetic	adjustable	adjustable																																															
	I _{rm} (A) max. and min. threshold 2 poles loaded	<table border="1"> <thead> <tr> <th>rating</th> <th>I_{rm}</th> </tr> </thead> <tbody> <tr> <td>G200</td> <td>500 to 1000</td> </tr> <tr> <td>G250</td> <td>500 to 1000</td> </tr> </tbody> </table>	rating	I _{rm}	G200	500 to 1000	G250	500 to 1000	<table border="1"> <thead> <tr> <th>rating</th> <th>I_{rm}</th> </tr> </thead> <tbody> <tr> <td>G200</td> <td>500 to 1000</td> </tr> <tr> <td>G250</td> <td>500 to 1000</td> </tr> </tbody> </table>	rating	I _{rm}	G200	500 to 1000	G250	500 to 1000																																			
rating	I _{rm}																																																	
G200	500 to 1000																																																	
G250	500 to 1000																																																	
rating	I _{rm}																																																	
G200	500 to 1000																																																	
G250	500 to 1000																																																	
type SA selective release	thermal	same as D type	same as D type																																															
	magnetic	fixed threshold	fixed threshold																																															
	I _{rm} (A)	<table border="1"> <thead> <tr> <th>rating</th> <th>I_{rm}</th> </tr> </thead> <tbody> <tr> <td>SA125</td> <td>1000</td> </tr> <tr> <td>SA160</td> <td>1280</td> </tr> <tr> <td>SA200</td> <td>1600</td> </tr> <tr> <td>SA250</td> <td>2000</td> </tr> </tbody> </table>	rating	I _{rm}	SA125	1000	SA160	1280	SA200	1600	SA250	2000	<table border="1"> <thead> <tr> <th>rating</th> <th>I_{rm}</th> </tr> </thead> <tbody> <tr> <td>SA125</td> <td>1000</td> </tr> <tr> <td>SA160</td> <td>1280</td> </tr> <tr> <td>SA200</td> <td>1600</td> </tr> <tr> <td>SA250</td> <td>2000</td> </tr> </tbody> </table>	rating	I _{rm}	SA125	1000	SA160	1280	SA200	1600	SA250	2000																											
rating	I _{rm}																																																	
SA125	1000																																																	
SA160	1280																																																	
SA200	1600																																																	
SA250	2000																																																	
rating	I _{rm}																																																	
SA125	1000																																																	
SA160	1280																																																	
SA200	1600																																																	
SA250	2000																																																	
	instantaneous protect. I (A)	3000	3000																																															
type SB Sellim selective release (full discrimination with all downstream breaker)	thermal		same as D type																																															
	magnetic		fixed threshold																																															
	I _{rm} (A)		<table border="1"> <thead> <tr> <th>rating</th> <th>I_{rm}</th> </tr> </thead> <tbody> <tr> <td>SB125</td> <td>1250</td> </tr> <tr> <td>SB160</td> <td>1600</td> </tr> <tr> <td>SB200</td> <td>2000</td> </tr> <tr> <td>SB250</td> <td>2500</td> </tr> </tbody> </table>	rating	I _{rm}	SB125	1250	SB160	1600	SB200	2000	SB250	2500																																					
rating	I _{rm}																																																	
SB125	1250																																																	
SB160	1600																																																	
SB200	2000																																																	
SB250	2500																																																	
type MA magnetic release only	thermal	without	without																																															
	magnetic	adjustable	adjustable																																															
	I _{max} (A) maximum continuous current at 65 °C I _{rm} (A) max. and min. threshold 2 poles loaded	<table border="1"> <thead> <tr> <th>rating</th> <th>I_{max}</th> <th>I_{rm}</th> </tr> </thead> <tbody> <tr> <td>MA250</td> <td>250</td> <td>1600 to 3200</td> </tr> </tbody> </table>	rating	I _{max}	I _{rm}	MA250	250	1600 to 3200	<table border="1"> <thead> <tr> <th>rating</th> <th>I_{max}</th> <th>I_{rm}</th> </tr> </thead> <tbody> <tr> <td>MA250</td> <td>250</td> <td>1600 to 3200</td> </tr> </tbody> </table>	rating	I _{max}	I _{rm}	MA250	250	1600 to 3200																																			
rating	I _{max}	I _{rm}																																																
MA250	250	1600 to 3200																																																
rating	I _{max}	I _{rm}																																																
MA250	250	1600 to 3200																																																



www.electricalpartmanuals.com

C401 C401H	C401L	C630N C630H	C630L
adj. 0.75 to 1 × I _r ⁽¹⁾	adj. 0.75 to 1 × I _r ⁽¹⁾	adj. 0.75 to 1 × I _r ⁽¹⁾	adj. 0.75 to 1 × I _r ⁽¹⁾
rating I _r (A) N/2 40 °C 50 °C 60 °C (A) D321 320 305 290 160 D401 400 380 360 200 for direct current P1 P2 without thermal P3	rating I _r at: N/2 40 °C 50 °C 60 °C (A) D321 320 305 290 160 D401 350 325 300 200 for direct current P1 P2 without thermal P3	rating I _r at: N/2 40 °C 50 °C 60 °C (A) D321 320 305 290 160 D401 400 380 360 200 D500 500 475 450 250 D630 630 595 550 320 for direct current: P1 P2 without thermal P3	rating I _r at: N/2 40 °C 50 °C 60 °C (A) D321 320 305 290 160 D401 400 380 360 200 D500 500 475 450 250 D630 560 525 490 320 for direct current: P1 P2 without thermal P3
adjustable	adjustable	adjustable	adjustable
rating I _{rm} D321 1600 to 3200 D401 2000 to 4000 for direct current: P1 800 to 1600 P2 1200 to 2500 P3 2000 to 4000	rating I _{rm} D321 1600 to 3200 D401 2000 to 4000 for direct current: P1 800 to 1600 P2 1200 to 2500 P3 2000 to 4000	rating I _{rm} D321 1600 to 3200 D401 2000 to 4000 D500 2500 to 5000 D630 3200 to 6300 for direct current: P1 800 to 1600 P2 1200 to 2500 P3 2000 to 4000 P4 3200 to 6300	rating I _{rm} D321 1600 to 3200 D401 2000 to 4000 D500 2500 to 5000 D630 3200 to 6300 for direct current: P1 800 to 1600 P2 1200 to 2500 P3 2000 to 4000 P3 3200 to 6300
protection carried out by C400N/H ST equipped with ST204S trip unit (see page 36)	protection carried out by C400L ST equipped with ST204S trip unit (see page 36)	protection carried out by C400N/H ST equipped with ST204S trip unit (see page 36)	protection carried out by C400L ST equipped with ST204S trip unit (see page 36)
protection carried out by C400N/H ST equipped with ST204S trip unit (see page 36)	protection carried out by C400L ST equipped with ST204S trip unit (see page 36)	protection carried out by C400N/H ST equipped with ST204S trip unit (see page 36)	protection carried out by C630L ST equipped with ST204S trip unit (see page 36)
	protection carried out by C400L ST equipped with ST204SB trip unit (see page 36)		protection carried out by C630L ST equipped with ST204SB trip unit (see page 36)
without adjustable	without adjustable	without adjustable	without adjustable
rating I _{max} I _{rm} MA321 320 2000 to 4000	rating I _{max} I _{rm} MA321 320 2000 to 4000	rating I _{max} I _{rm} MA500 500 3200 to 6300	rating I _{max} I _{rm} MA500 500 3200 to 6300

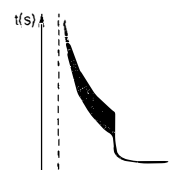

control units types of protection

Instantaneous control units ST 204 S selective control unit ST 204 SB

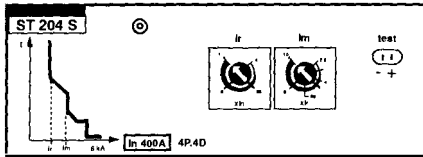

The ST 204 S control unit, for general purpose, offers two levels of protection:

- adjustable long time protection against overload;
- instantaneous for protection against short circuits. In addition, the ST204 SB control unit offers an adjustable short time protection against short circuits, and allows full continuity of service with SELLIM system.

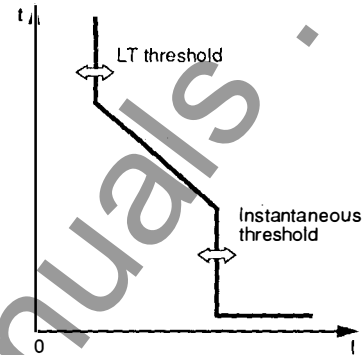

Adjustments of protections

Instantaneous control unit STR 25 DE

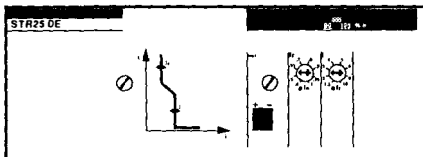

The STR 25 DE control unit, for general purpose, offers two levels of protection:

- adjustable long time protection against overload;
- adjustable instantaneous protection against short circuit. The thresholds are given for 1, 2 or 3 poles on load.

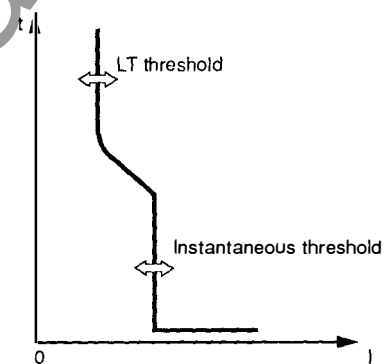

Adjustments of protections

version with fine setting for long time protection is available.

Selective control units STR 35 SE/GE/ME

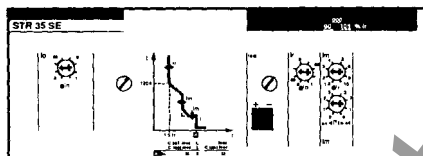

The STR 35 SE, GE and ME control units offer the following protections:

- adjustable long time protection against overload, with Off position for the ME version;
- adjustable short time protection against short circuit;
- adjustable short time delay for selectivity;
- fixed instantaneous protection against short circuit.

The thresholds are given for 1, 2 or 3 poles on load. These control unit types meet each requirement for selective applications and generator protection (STR 35 GE).

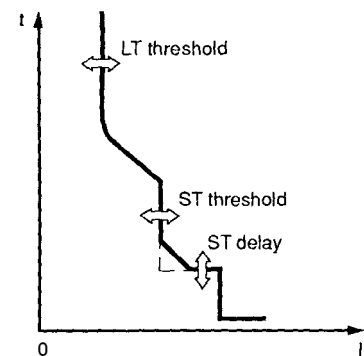

Adjustments of protections

Universal control unit STR 55 UE

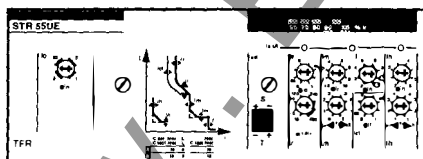

The STR 55 UE control unit offers the following protections:

- adjustable long time protection against overload;
- adjustable long time delay for selectivity;
- adjustable short time protection against short circuit;
- adjustable short time delay for selectivity;
- adjustable instantaneous protection against short circuit.

The thresholds are given for 1, 2 or 3 poles on load. This control unit can be adjusted for any type of network protection: distribution selective, generator, motor etc.

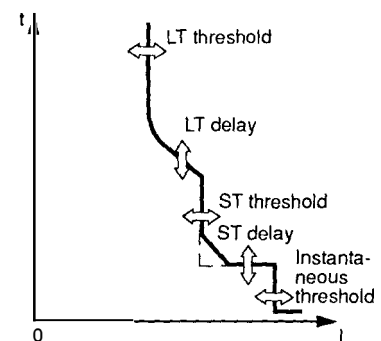

Adjustments of protections

Available with all types of options; with or without being prepared for communication.

Sellim control unit STR 45 BE

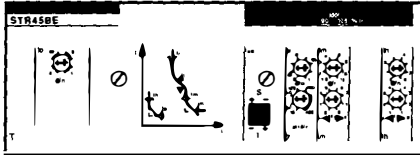

The STR 45 BE control unit offers the following protections:

- adjustable long time protection against overload;
 - adjustable long time delay for selectivity;
 - adjustable short time protection against short circuit;
 - adjustable short time delay for selectivity;
- The thresholds are given for 1, 2 or 3 poles on load.
The Sellim system offers maximum continuity of service due to full selectivity and cascading.

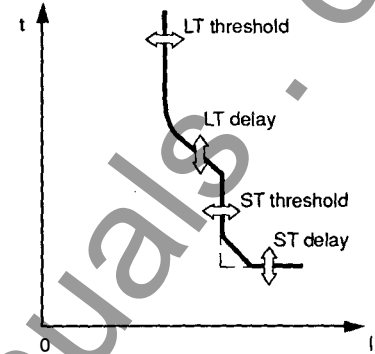

Adjustments of protections

Available with all types of options except fault indication, always prepared for communication.

optional functions (for universal and Sellim control unit only)

Load monitoring (option R)

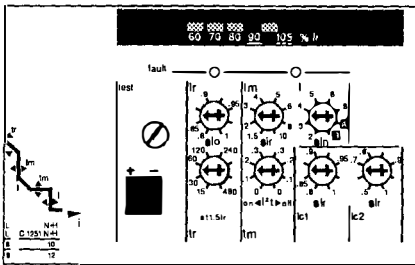

Two adjustable loads limits* depending on the long time delay adjustment activate opto-decoupled outputs (transistors) or send a signal via the communication outputs:
These two thresholds can be used in applications such as load shedding and reconnection, interlocks; alarms and so on.

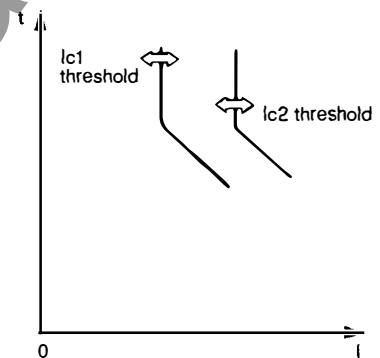

Adjustments of load monitoring

* When combined with option T there is only one threshold (Ic1).

Ground fault protection (option T)

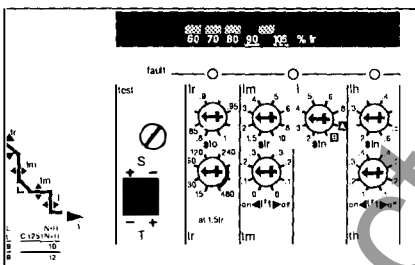

The ground fault protection is of residual type. One adjustable threshold depending on the nominal current I_n , with adjustable time delay will control the breaker.
It can be completed with a zone selective interlock (option Z), which will provide logical selectivity.
On request, the ground fault protection can be of source ground return type (type W) or protected neutral type.

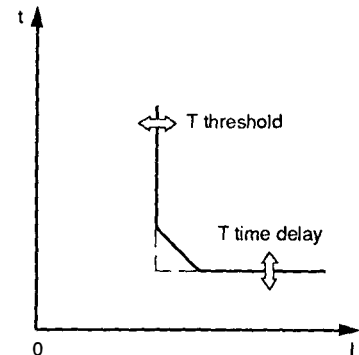

Adjustments of protections

Fault indication (option F)

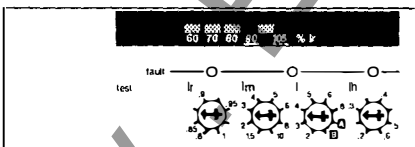

In addition to the standard fault indications (toggle, SD and SDE contacts), the fault indication enables to discriminate the three causes of tripping: overload (LT), short circuit (ST + inst.) or earth fault (T) with three LEDs.

Together with the fault indicators comes a load indicator, three LEDs indicating 60, 70 and 80 % of the long time setting in addition to the standard LED indicating 90 % and 105 % of the long time setting.
F option is not available on Sellim control units.

Option F requires an external power supply of 24 to 240 V 50/60 Hz or DC.

Communication (option C)

Transmitting data concerning all currents read by the CTs, all settings of the control unit including those of options T and R, load shedding orders, fault indications as given by option F, internal temperature warning when temperature, warning when temperature read by three internal

Note: All protection functions are self powered and require no external power supply. Fault indication, option F, requires the installation of an external power supply.

selection table

Compact	ST204S/SB	STR25DE	STR35SE	STR35ME	STR35GE	STR55UE	STR45BE
C400N/H/L ST	■						
C630N/H/L ST	■						
C801N/H ST		■	■	■	■	■	■
C1001N/H ST		■	■	■	■	■	■

characteristics ST control units selection

ST control units and optional functions selection table

control units characteristics

control units	ST204S	ST204SB	STR25DE	STR35SE
protection				
long time protection LT	N/2 setting $I_r = I_n \times \dots$	■ 0.4 - 1	■ 0.4 - 1	■ 0.4 - 1
	tripping between	1.05 - 1.20 × I_r	1.05 - 1.20 × I_r	1.05 - 1.20 × I_r
long time delay	time delay bands	120	120	120
	min. delay(s), at 1.5 × I_r	96	96	96
	max. delay(s), at 1.5 × I_r	120	120	120
	min. delay(s), at 6 × I_r		6.0	6.0
	max. delay(s), at 6 × I_r		7.5	7.5
	min. delay(s), at 7.2 × I_r		4.2	4.2
	max. delay(s), at 7.2 × I_r		5.2	5.2
short time protection ST	N/H type	2.5 to 10	none	1.5 - 10
setting $I_m = I_r \times \dots$	L type	2.5 to 10	none	1.5 - 10, max. 8 × I_n
short time delay	time delay bands			0 0.1 0.2 0.3
	no trip time (ms)			0 60 140 230
	max break time (ms)			60 140 230 350
instantaneous protection	C400/C630N/H/L ST	14 × I_n	8 × I_n	
	C801/C1001N/H ST			15 × I_n
	C801/C1001L ST			8 × I_n
	C1251N/H ST			12 × I_n
options				
	T			
	R			
	F			
	communication			

optional functions characteristics

ground fault protection (T)

available as standard residual current type, source ground return type, or protected neutral type

pick-up I_h	$I_h = I_n \times \dots$	0.2 to 0.6
	steps	0.2 - 0.25 - 0.3 - 0.35 - 0.4 - 0.45 - 0.5 - 0.6
	precision	± 15 %
time delay	$t_m = \text{band} \dots$	0.1 0.2 0.3 0.4
	max. no trip time (ms)	60 140 230 350
	max. breaking time (ms)	140 230 350 500
zone selective interlocking (Z)		working on both earth fault and short circuit protection
available on request		
thermal memory		as LT protection, C = 20 seconds
power supply		self powered

load monitoring and control (R)

2nd limit I_{c1}	$I_{c1} = I_r \times \dots$	0.8 to 1
	steps	0.8 - 0.85 - 0.88 - 0.9 - 0.93 - 0.95 - 0.98 - 1.0
	precision	± 8 %
time delay(s)	closing	$t_r/2$ ($t_r = \text{time delay for long time protection}$)
	opening	10 s
1st limit I_{c2}	$I_{c2} = I_r \times \dots$	0.5 to 1
	steps*	0.5 - 0.6 - 0.7 - 0.8 - 0.85 - 0.9 - 0.95 - 1.0
	precision	± 8 %
time delay(s)	closing	$t_r/4$ ($t_r = \text{time delay for long time protection}$)
	opening	10 s
transmission*		opto-decoupled outputs 100 mA triac type, 120 to 240 V 50/60 Hz, or signalling via the communication output, when the control unit is prepared for Com
power supply		self powered**

fault indications (F)

	3 front face LEDs	indicating cause of tripping I_r , I_m/I , I_h
	bargraph, 3 LEDs	60, 70, 80 % of I_r
	precision	± 6,6 %
resetting		automatically when resetting the breaker
power supply		24 to 240 V AC, 50/60 Hz or DC

communication (Com)

	transmitting data concerning	I_1 , I_2 , I_3 , I_{max} , $I_{neutral}$, all settings of the control unit, identification of plug (UL and JIS), load monitoring operations, fault indications, internal temperature, cause of malfunction.
power supply		self powered**

STR35ME	STR35GE	STR55UE	STR45BE (L type only)
0.4 - 1. OFF	0.4 - 1	0.4 - 1	0.4 - 1
1.05 - 1.20 x Ir	1.05 - 1.20 x Ir	1.05 - 1.20 x Ir	1.05 - 1.20 x Ir
120	15	15 30 60 120 240 480	15 30 60 120 240 480
96	12	12 24 48 96 192 384	12 24 48 96 192 384
120	15	15 30 60 120 240 480	15 30 60 120 240 480
6.0	0.75	0.75 1.50 3.00 6.0 12 24	0.75 1.50 3.00 6.0 12 24
7.5	0.94	0.94 1.88 3.75 7.5 15 30	0.94 1.88 3.75 7.5 15 30
4.2	0.52	0.52 1.04 2.08 4.2 8.3 16.7	0.52 1.04 2.08 4.2 8.3 16.7
5.2	0.65	0.65 1.30 2.60 5.2 10.4 20.8	0.65 1.30 2.60 5.2 10.4 20.8
1.5 - 10	1.5 - 10	1.5 - 10	1.5 - 10
1.5 - 10. max. 8 x In	1.5 - 10. max. 8 x In	1.5 - 10. max. 8 x In	1.5 - 10. max. 8 x In
0 0.1 0.2 0.3	0 0.1 0.2 0.30	0 0.1 0.2 0.3	0 0.1 0.2 0.3
0 60 140 230	0 60 140 230	0 60 140 230	0 60 140 230
60 140 230 350	60 140 230 350	60 140 230 350	60 140 230 350
15 x In	15 x In	2 - 15 x In	
8 x In	8 x In	2 - 8 x In	none
12 x In	12 x In	2 - 12 x In	

front face example

STR55 UE

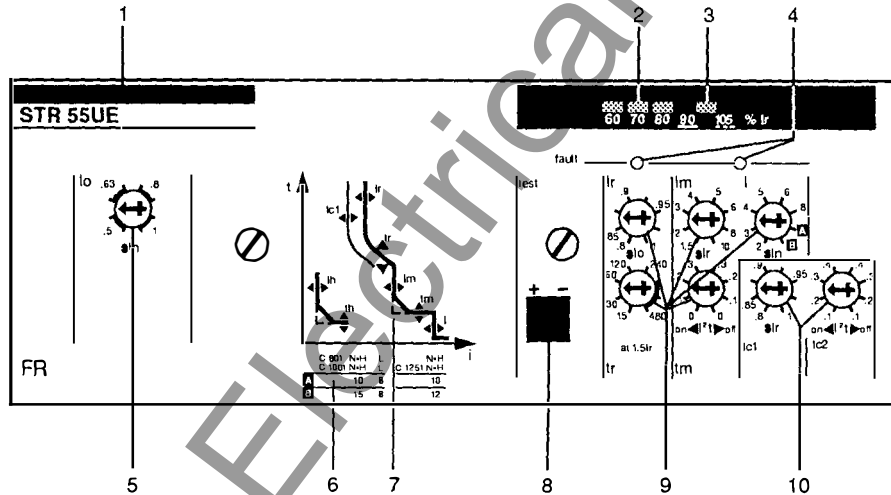

- 1 Control unit identification
- 2 Bar graph indicating the load in % of the long time setting (LEDs)
- 3 Alarm indicator (LED; fixed light when load exceeds 90 % of long time setting and flashing above 105 %)
- 4 Fault indicators (LEDs) discriminating the different causes of tripping: overload (Ir), short circuit (Im or Inst) or earth fault (T) (option)
- 5 Io, rough adjustment for long time protection (fine setting with Ir knob)
- 6 Table for the maximum settings of short time protection and instantaneous protection
- 7 Typical curve
- 8 Test kit connector
- 9 Overcurrent protection settings
- 10 Load monitoring settings (option)

* The lowest settings of Ic2 may not work properly if Ir setting and/or the load is below 0.5 In: Inad and/or setting _____ Ic2 setting _____

characteristics ST control units selection

control unit
optional functions
wiring diagram

general diagram for basic versions

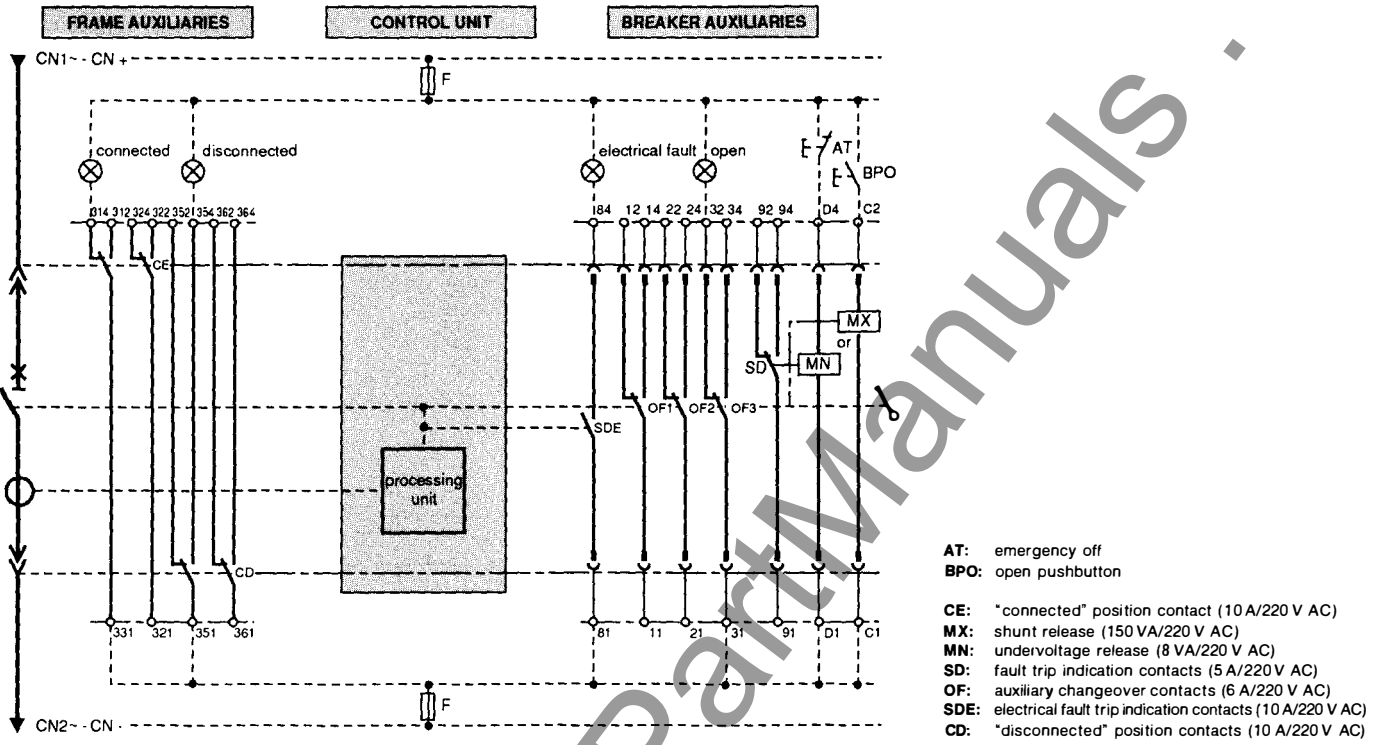

integrated option offer STR 55 UE RF STR 55 UE TRF

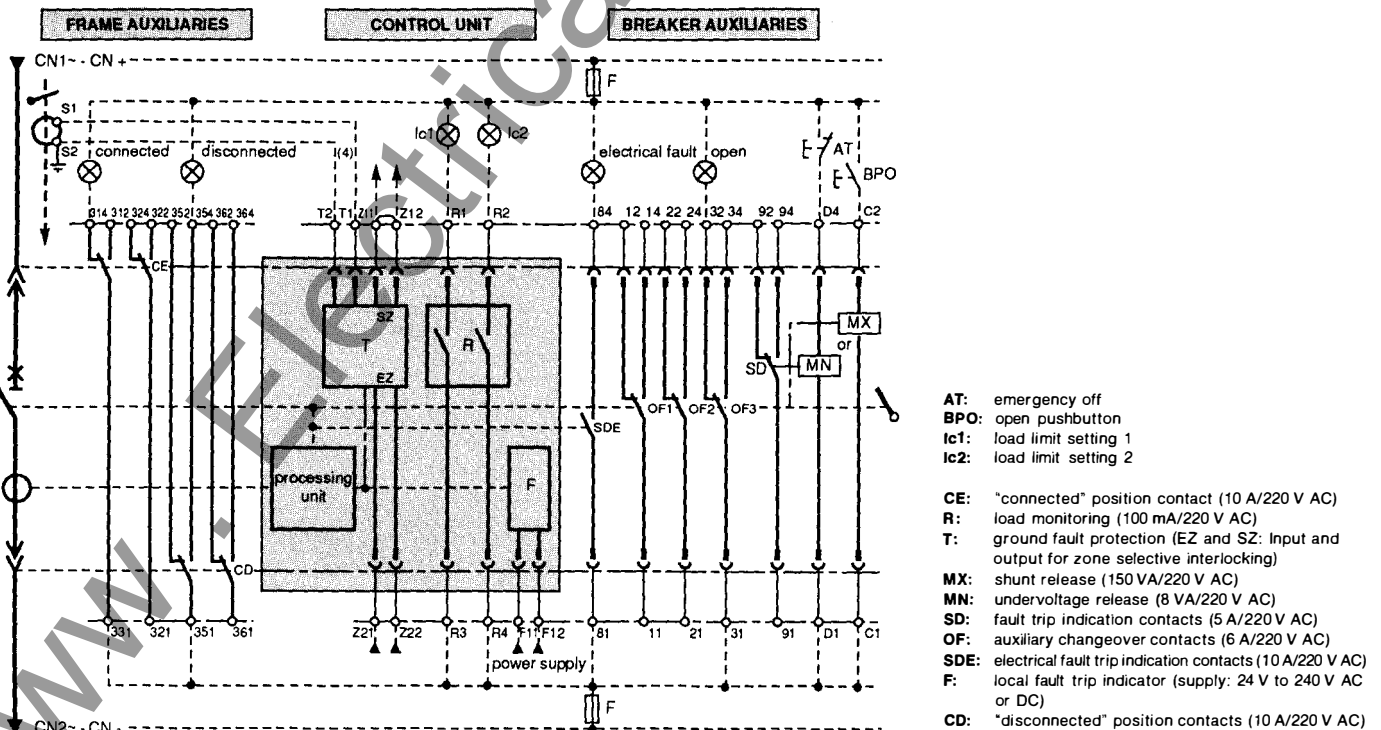

evolutive offer (prepared for telecommunication)
STR 55 UE + options FC/RFC/TFC/TRFC

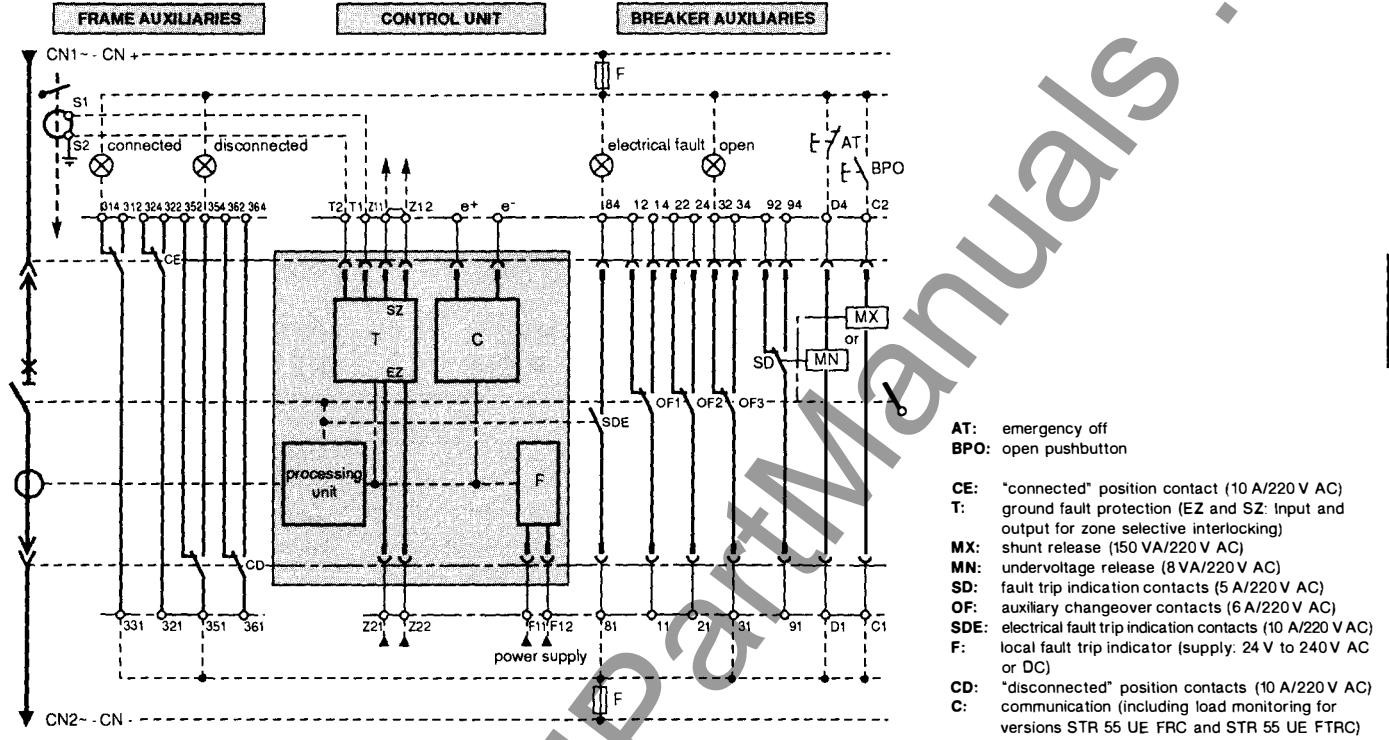

STR 45 BE (sellim) + options C/TC/RC/TRC

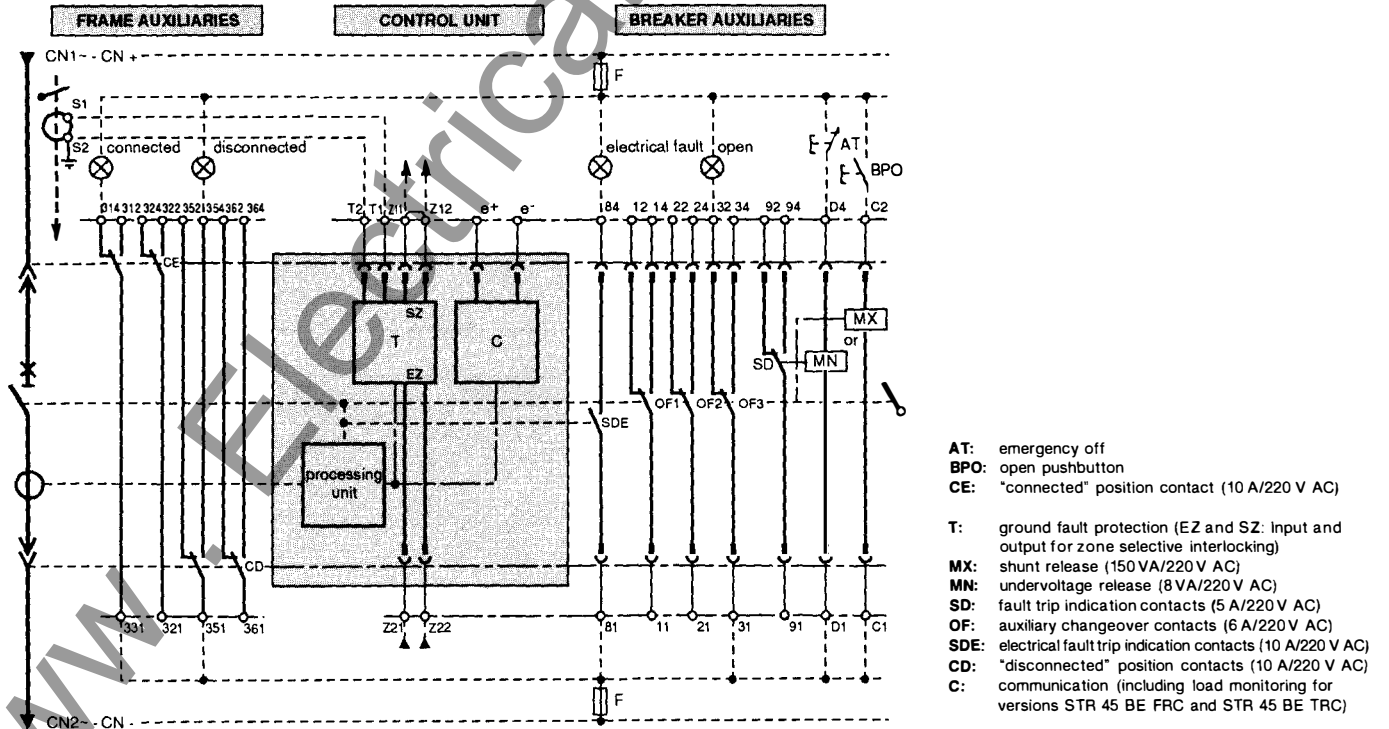

characteristics selection table: Vigicomact ELCB

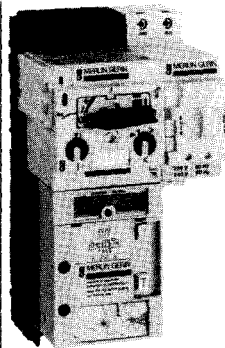

**TC40N
REH ●**

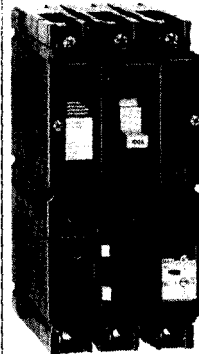

**C101N/H/L
REH or RMM**



**C161N/H/L
REH or RMM**

Vigicomact

electrical characteristics

rated current (A) at 40 °C		C101N/H/L	C161N/H	C161L
fixed	40	100	160	150
plug-in		100	160	150
rated voltage AC (V) 50/60 Hz +10% -15% ⁽⁵⁾	220 to 415	220 to 415 (500 for RMM)	220 to 415 (500 for RMM)	
number of poles	3, 4	3, 4	3, 4	
breaking capacity AC	same as TC40N	same as C101N/H/L	same as C161N/H/L	
trip unit				
accessories and auxiliaries				

Vigi module

type of Vigi module	REH40			REH101		RMM101	REH161		RMM161	
	sensitivity ⁽¹⁾ I Δ n (A) ⁽²⁾	HS	MS and LS	HS	MS and LS	MS	HS	MS and LS	MS	
intentional delay	step	0	0 I II	0	0 I II	without	0	0 I II	without	
delay (ms)		0	0 60 200	0	0 60 200	0	0	0 60 200	0	
trip time (ms) ⁽³⁾		40	40 150 370	40	40 150 370	50	40	40 150 370	50	
class		TO2	T2 on step 0	TO2	T2 on step 0	T2	TO2	T2 on step 0	T2	
auxiliary supply AC 50/60 Hz ⁽⁵⁾		built-in (self voltage)		built-in (self voltage)		without (self current)	built-in (self voltage)		without (self current)	
installation	versions	FC			FC	RC	FC		RC	
fixed		■			■	■	■		■ (4)	
plug-in		■			■	■	■ (4)		■	
dimensions (mm)	fixed FC	H	W	D	H	W	D	H	W	D
type N/H	3P	190	103	134	218	105	124	232	105	139
4P		190	122	134	218	140	124	232	140	139
weight (kg)	type N/H	3P			2.3		2.3		3.1	
4P		1.7			3.1		3.1		3.1	

Vigirex RCD

type of Vigirex	RH50 ⁽⁶⁾		RH53A	RH50 ⁽⁶⁾		RH53A
	I Δ n (A)	0.03-0.1-0.3-1-3	0.03-0.1-0.3-1-3	0.03-0.1-0.3-1-3	0.03-0.1-0.3-1-3	
intentional delay	step	0	0 I II	0	0 I II	
delay (ms)		0	0 90 250	0	0 90 250	
class		TO2	TO2 on step 0 with I Δ n = 0.03	TO2	TO2 on step 0 with I Δ n = 0.03	
auxiliary supply	AC 50/60 Hz	220/240	220/240 or 380/415	220/240	220/240 or 380/415	
connection						
circuit breaker MX or MN						
separated toroid (\varnothing in mm)	TN \varnothing 30 plug-in	■	■	■	■	
	PN \varnothing 50	■	■	■	■	
	IN \varnothing 80	■	■	■	■	
	MN \varnothing 120	■	■	■	■	
	SN \varnothing 200	■	■	■	■	
shielded wire	l = 100 mm	■	■	■	■	

Protection against transient fault currents: The Vigi modules are equipped with a filtering device preventing the inadvertent tripping due to transient overvoltage, radio waves...

They comply with international standards (withstand test to 8/20 μ s wave and impulse voltage 1.2/50 μ s, class A...). They are identified by this symbol.



The earth-leakage protection with Vigirex RCD is achieved by the combination of:

- a circuit breaker equipped with a shunt trip or an undervoltage release,
- a Vigirex RCD,
- a separate toroid

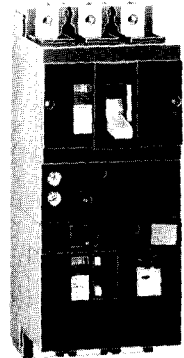

**C250N/H/L
REH**

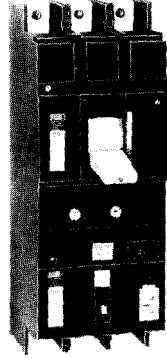

**C401N/H/L
C400N/H/L ST
REM**

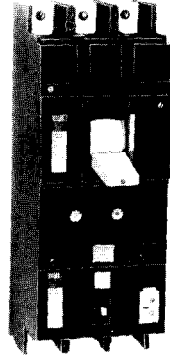

**C630N/H/L
C630N/H/L ST
REM**

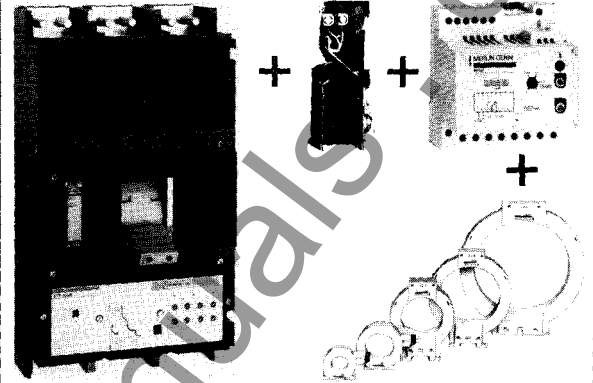

**C801N/H/L ST, C1001N/H/L ST,
C1251N/H ST**



C250N/H	C250L	C401N/H C400N/H ST	C401L C400L ST	C630N/H C630N/H ST	C630L C630L ST	
250	235	400	350	630	550	
250	235	360	30	550	520	
220 to 415		220 to 415		220 to 415		
3, 4		3, 4		3, 4		
same as C250N/H/L		same as C401N/H/L or C400N/H/L ST		same as C630N/H/L or C630N/H/L ST		same as C801N/H/L ST, C1001N/H/L ST or C1251N/H ST

REH250			REM401/400/630			REM401/400/630		
HS	MS and LS		MS and LS			MS and LS		
0.03	0.3-1-3-10		0.3-1-3-10-30			0.3-1-3-10-30		
0	0	I II	0	I	II	0	I	II
0	0	60 200	0	60	200	0	60	200
40	40	150 370	40	150	370	40	150	370
TO2	T2 on step 0		T2 on step 0			T2 on step 0		
built-in (self voltage)			built-in (self voltage)			built-in (self voltage)		
FC	RC		FC	RC		FC	RC	
	(4)							
H	W	D	H	W	D	H	W	D
350	140	145	410	157.5	171	410	157.5	171
350	185	145	410	210	171	410	210	171
5.2			7.8			7.8		
6.2			9.7			9.7		

RH50⁽⁶⁾	RH53A	RH50⁽⁶⁾	RH53A	RH50⁽⁶⁾	RH53A	RH50⁽⁶⁾	RH53A
0.03-0.1-0.3-1-3	0.03-0.1-0.3-1-3	0.03-0.1-0.3-1-3	0.03-0.1-0.3-1-3	0.03-0.1-0.3-1-3	0.03-0.1-0.3-1-3	0.03-0.1-0.3-1-3	0.03-0.1-0.3-1-3
0	0 I II	0	0 I II	0	0 I II	0	0 I II
0	0 90 250	0	0 90 250	0	0 90 250	0	0 90 250
TO2	TO2 on step 0 with IΔn = 0.03	TO2	TO2 on step 0 with IΔn = 0.03	TO2	TO2 on step 0 with IΔn = 0.03	TO2	TO2 on step 0 with IΔn = 0.03
220/240	220/240 or 380/415	220/240	220/240 or 380/415	220/240	220/240 or 380/415	220/240	220/240 or 380/415

(1) HS: high sensitivity
MS: medium sensitivity
LS: low sensitivity
(2) Tripping at IΔn, non tripping at IΔn/2
(3) Total breaking time at 2 IΔn
(4) Except for L type: consult us
(5) For other frequencies: consult us
(6) The RH50 Vigirex exists in inherent safety model

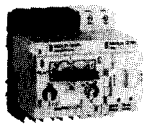
characteristics selection table: remote control

				
	TC40N/L	C101N/H/L	C161N/H/L	

circuit breaker

rated current I_n (A) for 40 °C	40	100	160
other characteristics	see below	see p. 20	see p. 20

remote control

		built-in	T101	T161	TS161			
functions	opening	■	■	■	■			
	closing	■	■	■	■ synchro			
	remote reset	on fault on MN/MX tripping	■ on request - with SDM ■ with SDM	■ consult us	■ consult us			
	generators synchro coupling automatic source changeover		■ consult us	■ consult us	■ synchro			
opening time (ms)	opening	50	300	300	500			
	closing	50	500	500	60			
mechanical endurance (co cycles IEC 947-2)		50000	C101N 12000	C101H/L 30000	C161N/L 12000	C161H 30000	C161N/L 10000	C161H 10000
	electrical endurance ⁽¹⁾ :	$I_n/2$	50000	12000	30000	12000	30000	10000
440 V - $\cos \phi = 0.8$	I_n	50000	6000	20000	6000	20000	6000	10000
nb opening by MX/MN		25000	3000	3000	3000	3000	3000	3000
maximum operating frequency (cycles/mn)		4	4	4	4	4	4	4
power supply (V) DC		24-48-110-125-220-250	24/30-48/60-110/125 220/250	24/30-48/60 110/125-220/250	110/127			
AC 50 Hz		110-127-220-240-380 415/440	110/127-220/240-380/415 440	110-127-220/240 380/415-440	110/127 220/240			
	AC 60 Hz	120-240-440-480	110/127-220/240-440	110/127-220/240 440	110/127 220/240			
consumption	DC (W)	opening	700	200	200	500		
		closing	700	200	200	500		
	AC (VA)	opening	500	250	250	500		
		closing	500	250	250	500		

electrical auxiliaries

OF contact	■	■	■
SD contact	■	■	■
SDE contact	■ (SDM)		
MX shunt trip		■	■
MN shunt trip	■ MN	■	■
MN with time delay 250-700 ms	■ MNR	■	■

(1) for 660 V: endurance 440 V x 0.7.

MCCB's with integrated remote control

	TC40N	TC40L
--	--------------	--------------

electrical characteristics

rated current (A) 40 °C	40	40
rated voltage (V) AC	660	660
number of poles	3-4	3-4
breaking capacity	220/240 V 30	100
AC 50/60 Hz	380/415 V 30	100
	440 V 10	100
	500 V 7	100
	660 V 4.5	10

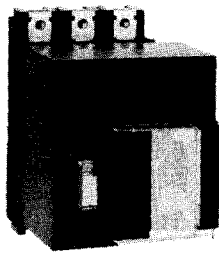

C250N/H/L

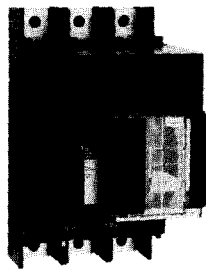

**C400N/H/L ST
C401N/H/L
C630N/H/L ST**

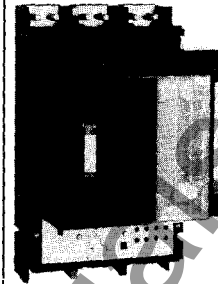

**C801N/H/L ST
C1001N/H/L ST
C1251N/H ST**

250	400-630	800-1000-1250 A
see p. 20	see p. 20	

	T250	TS250	T400/401/630	TS400/401/630	T801/1001/1251	TS801/1001/1251
	■	■	■	■	■	■
	■	■ synchro	■	■ synchro	■	■ synchro
	■ with SDE	■ with SDE	■ with SDE	■ with SDE	■ with SDE	■ with SDE
	■	■ synchro	■	■ synchro	■	■ synchro
	500	500	500	500	500	1500
	200	60	200	60	400	60
	12000	10000	10000	6000	10000	2500
	12000	10000	6000	6000	3000	2500
	6000	6000	3000	3000	1500	1500
	1200	1000	1000	1000	1000	1000
	2	2	2	2	2	2
	24-48/60-110/125 220/250	110/125	24-48/60-110/125 220/250	110/125	24-48/60-110/125 220/250	24/30-48/60 110/125
	110/127-220/240 380/415-440/480	110/127-220/240	110/127-220/240 380/415-440/480	110/127 220/240	110/127-220/240 380/415-440/480	110/127 220/240
	110/127-220/240 380/415-440/480	110/127-220/240	110/127-220/240 380/415-440/480	110/127 220/240	110/127-220/240 380/415-440/480	110/127 220/240
	500	500	500	500	500	400
	500	500	500	500	500	220
	110 V to 240 V 380 V to 480 V		110 V to 240 V 380 V to 480 V		110 V to 240 V 380 V to 480 V	
	500 700	500	500 700	700	500 700	400
	500 700	500	500 700	700	500 700	220

■	■	■
■	■	■
■	■	■
■	■	■
■	■	■
■	■	■

www.electricalmarketplace.com

electrical endurance by manual or T type remote control ($\cos \varphi 0.8 - 440 \text{ V}$)⁽¹⁾

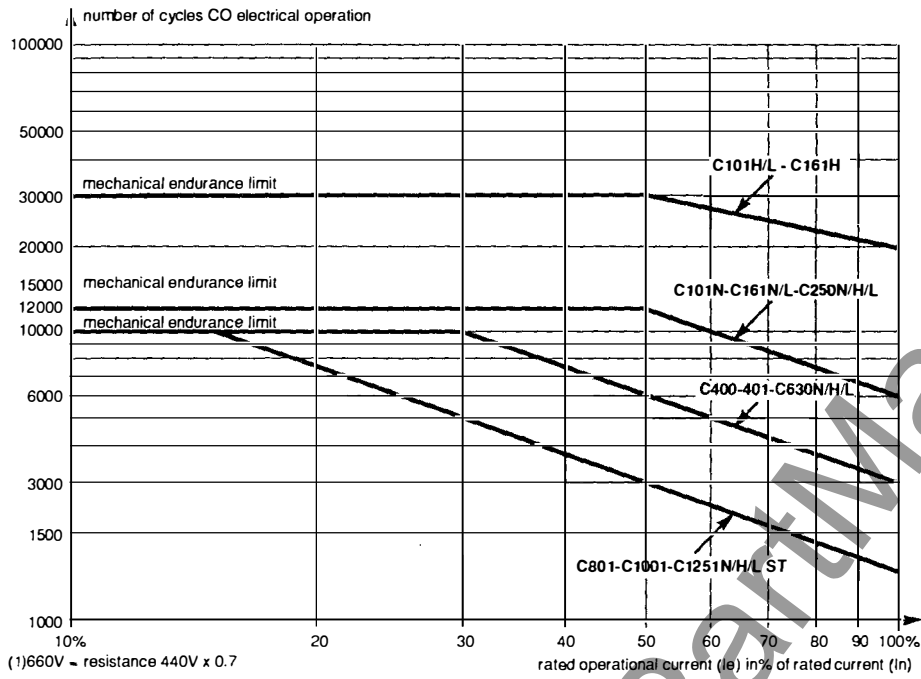

electrical endurance by TS type remote control ($\cos \varphi 0.8 - 440 \text{ V}$)⁽¹⁾

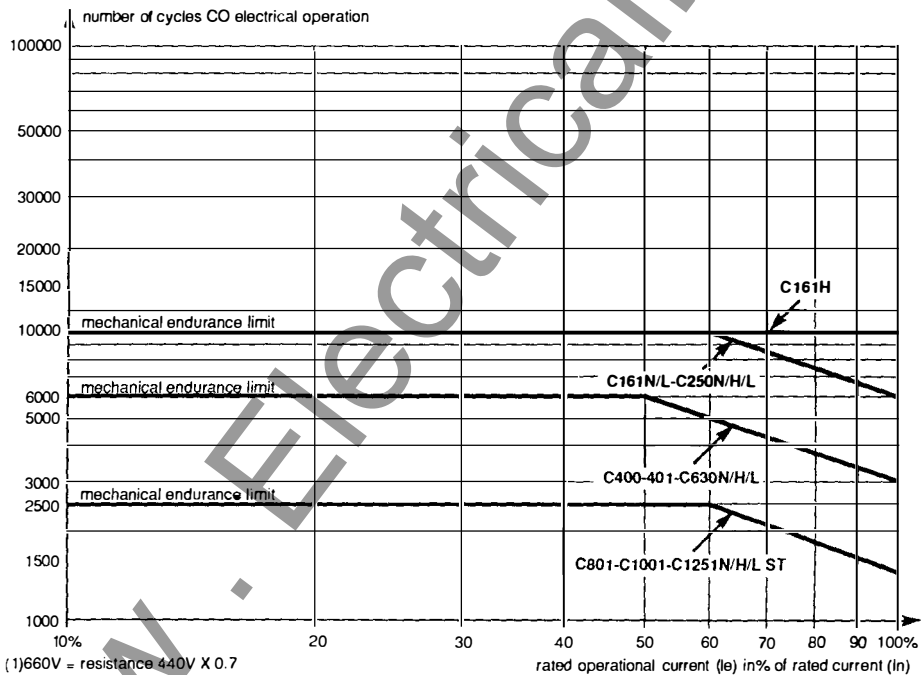

Low level interfaces enable Compact adaptable motor mechanisms to be operated by a programmable controller. They come in two versions, depending on the type of the signal delivered by the controller X: version (impulse signal) and OF version (continuous signal).

X version (impulse signal)

without SDE

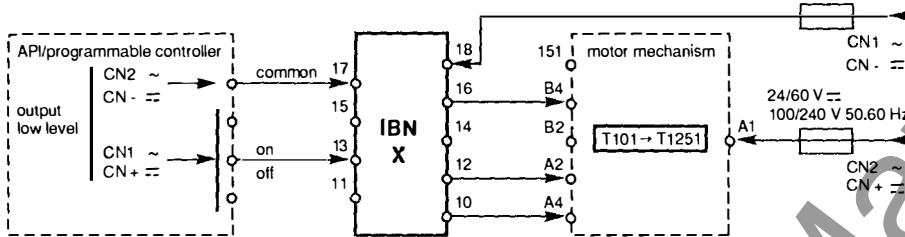

with SDE

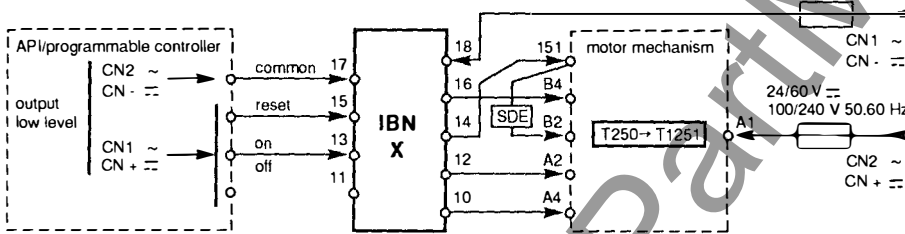

SDE = contact for electrical fault indication

OF version (continuous signal)

without SDE

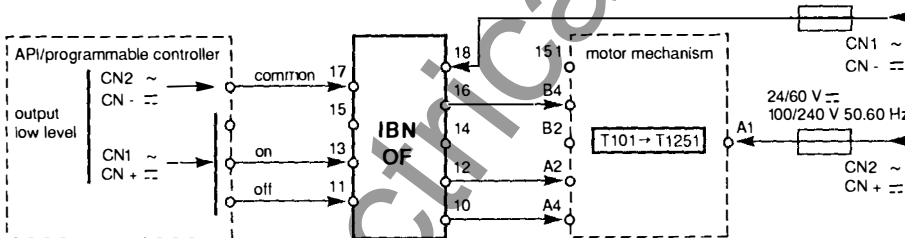

with SDE

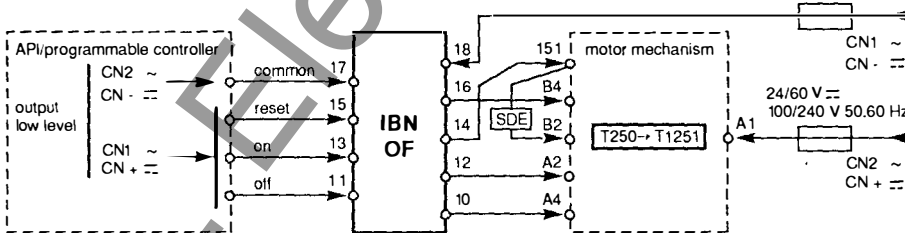

SDE = contact for electrical fault indication

characteristics remote control selection

wiring diagrams of Compact TC40 to C161N/H/L

Compact TC40N/L

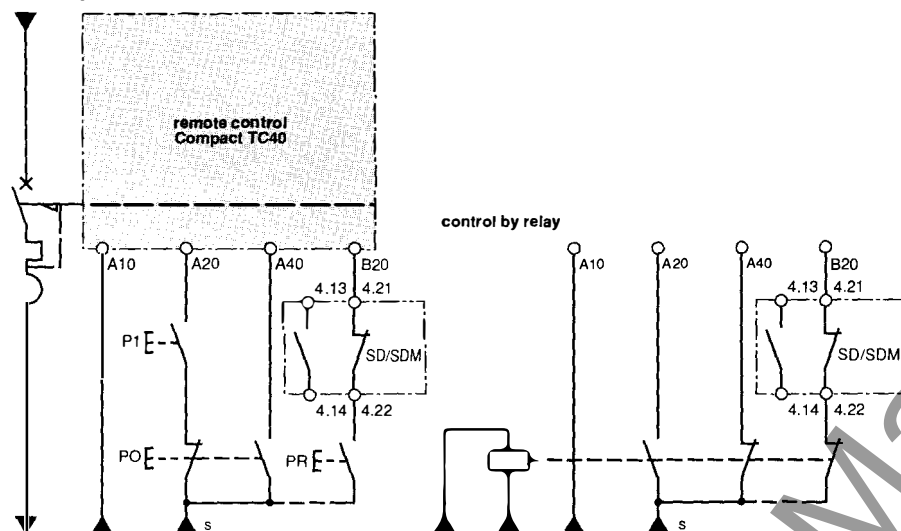

for Compact C101N/H/L to C161N/H/L

adaptable motor mechanism

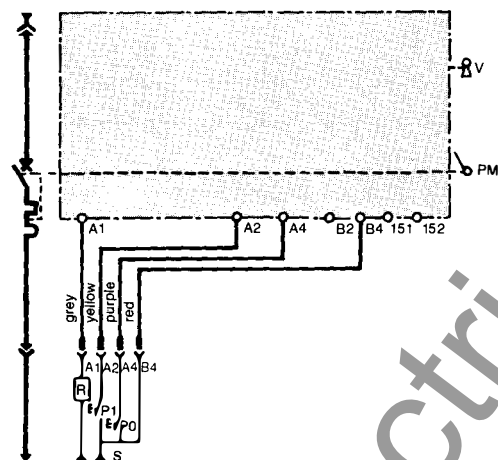

- the connection terminal B4 must always be connected (self feeding purpose).
- motor mechanisms must not be connected in parallel.
- for DC applications, polarities must be respected.
- closing operation, security: in case of power failure during the closing operation, it is necessary to re-confirm the closing order to achieve the closing operation.
- a tripping order given by undervoltage or shunt trip release on a C101N/H/L in the OFF position imposes the following sequence to close the circuit breaker:

orders:	CB status:
<input type="checkbox"/> closing order	OFF/tripped
<input type="checkbox"/> reset order	OFF/resetted
<input type="checkbox"/> closing order	ON

for Compact C161N/H/L

TS type adaptable motor mechanism

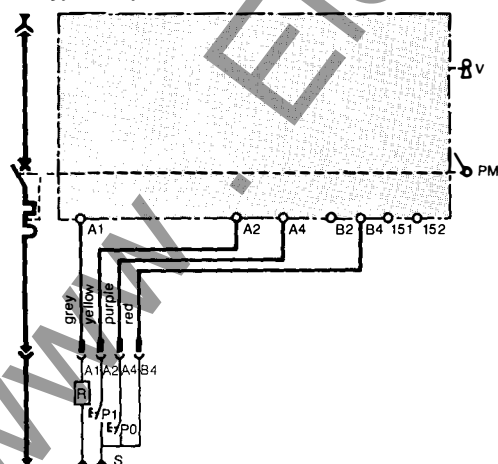

disconnectable plug supplied with TS 161

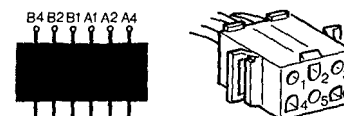

P1 ON push button
PO OFF push button
PR reset push button

SD alarm switch (any fault)
SDE alarm switch (electrical fault)
LD alarm

AT emergency off
MN undervoltage release
OF emergency stop

for Compact C250N/H/L to C630N/H/L ST

T type adaptable motor mechanism

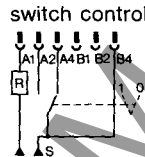
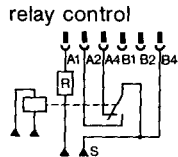
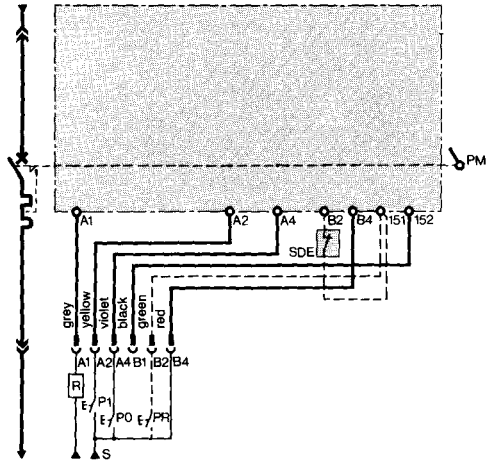

connection

C250N/H/L

1 block of 6 terminals (back view)

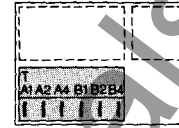

C401/C630N/H/L and C400/C630N/H/L ST

1 block of 6 terminals (back view).

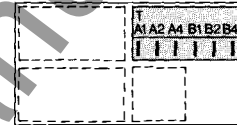

TS type adaptable motor mechanism

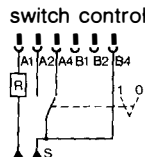
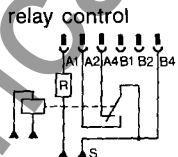
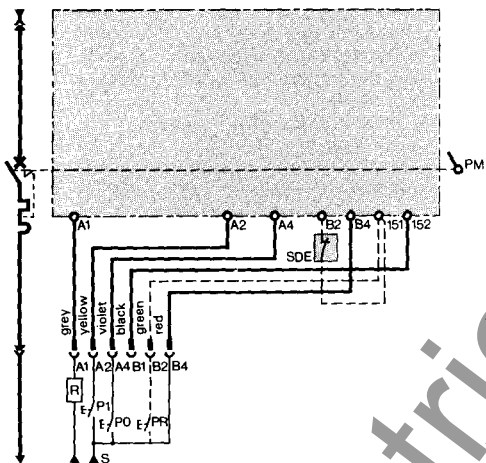

C250N/H/L

1 block of 6 terminals (back view)

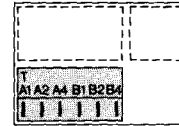

C401/C630N/H/L and C400/C630N/H/L ST

1 block of 6 terminals (back view).

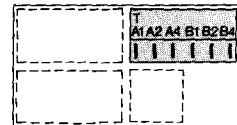

for Compact C801N/H/L ST to C1251N/H ST

TS type adaptable motor mechanism

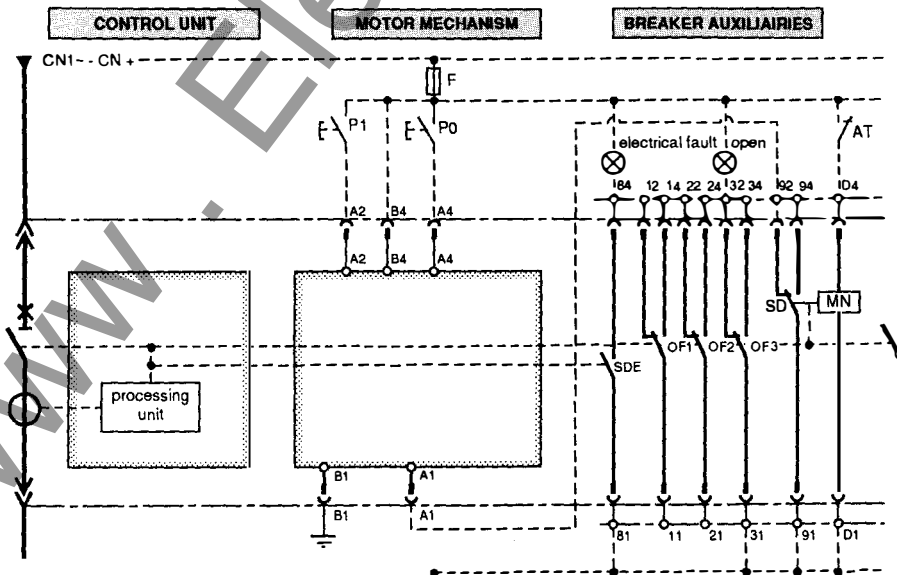

closing and opening orders are impulse orders; if they are permanent orders (external relay, selector switch), terminal B4 MUST NOT BE CONNECTED

C801N/H/L ST to C1251N/H ST

1 block of 6 terminals (back view)

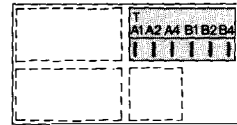

characteristics automatic source changeover

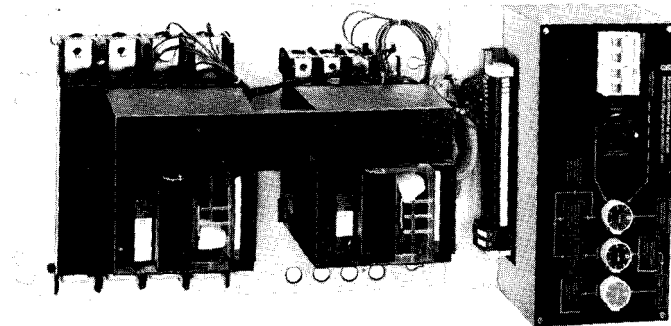

C250N/H/L to C1251N/H ST

use

The automatic source changeover achieves **automatically** the switching of a circuit supply from a **Normal supply N** to a **Replacement supply R** and vice versa.

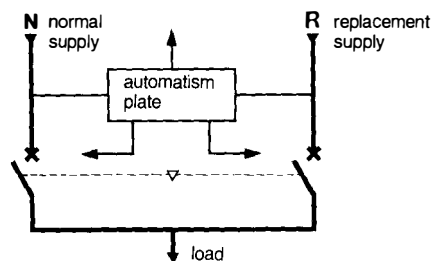

The automatic source changeover is particularly well adapted to industrial or tertiary installations including:

- either a **permanent standby supply** (the mains supply, a generator set with built-in in start-up relay);
- or and **emergency set** in "off" position carrying out starting and stopping orders given by the automatic source changeover.

variations

The Compact breakers which equip the automatic source changeover can receive the same auxiliaries as basic Compact. It is possible to achieve the following functions:

- **switch** by substitution of the trip unit by NI switch module, or by the switch accessories;
 - **protection of persons** by adding a Vigi module;
 - **visible break** by adding a Visu module on the left side breaker (Normal N);
 - **special protections** such as selective protection, protection with low magnetic threshold, etc., achieved by another trip unit adapted to the protection searched for.
- The following table gives the possible variations for each type of automatic source changeover. These additions can be combined or concern only one of the two breakers.

accessories

In addition to the necessary accessories for automatic operations, the breakers which equip the C101 to C1251 automatic source changeover can receive the usual Compact accessories.

Note

For C101 to C1251 source changeover, the possible adding of auxiliary contacts must always take into account that one OF switch is systematically used to operate the changeover.

installation

The automatic source changeover is delivered fitted, wired, set and ready to be connected.

The automatism plate normally fitted to the base plate is removable and can be separated for a possible remoteness (the cable of auxiliary connections is one meter long).

The auxiliaries supply comes from the networks to be checked.

The automatic source changeover can be mounted:

- either horizontally;
- vertically;
- on horizontal or vertical rails.

Indications for fitting and operating as well as the diagram appear on the leaflet supplied with the breaker.

operating

The automatism plate including contactors has the following functions:

- to switch the circuits supply from Normal to Replacement supply in case of failure of voltage N;
- to switch back this supply when voltage N returns;
- to select the operating mode by means of a 4 positions preselection switch
 - automatic,
 - stop (breakers on "OFF" position),
 - controlled operating on Normal supply,
 - controlled operating on Replacement supply.

According to the type of changeover selected the automatism can be equipped with time delay, or starting/stop orders sending or load shedding/restoring devices.

characteristics
operation

www.electricalmanuals.com

type		Compact C101 to C161N/H/L	Compact C250 to C630N/H/L	Compact C801 to C1251N/H/L ST
composition	standard	2 C101 or C161N/H/L	2 C250 or 2 C400 or 2 C630N/H/L	2 C801 or 2 C1001 or 2 C1251N/H/L
	other possibilities	C101 + C161 C101 + C101	C400 or C401 + C250 C630 + C250, C400 or C401	C1001 + C801 C1251 + C801, C1001
versions		FC	FC	FC
		RC	RC	RC
	fixed	■	■	■
	plug-in	■	■	■
variations				
switch	Nl block	■	■	■
personal protection	Vigi module REH	■	■	■
	Vigi module REM		■ C400 to C630	
	Vigirex + CT	■ (1)	■ (1)	■ (1)
visible break	Visu module	■ (2)(6)	■ (2)	■ (2)
auxillaries				
automatism plate	removable	■	■	■
selector switch		■	■	■
auxiliary contacts		2 OF or OF + SD	C250(5): 2 OF or OF + SD C400/C401/C630(5): OF + SD or 3 OF + SD	C801/C1001/C1251(5) OF + SD or 3 OF + SD
characteristics				
rated voltage Un (V)	AC 50-60 Hz	415	415	415
operating voltage⁽⁹⁾ (V)	AC 50-60 Hz	220, 240, 380, 415	220, 240, 380, 415	220, 240, 380, 415
number of poles		3, 4	3, 4	3, 4
supply of the automatism and the motor mechanisms (V)	N or R voltage	■	■	■
	AC 50-60 Hz	220, 240, 380, 415	220, 240, 380, 415	220, 240, 380, 415
maximum consumption	AC		AC	AC
	opening	250 VA	700 VA	1000 VA
	closing	250 VA	700 VA	1000 VA
	permanently	65 VA	65 VA	65 VA
time of switching		4 s ⁽⁴⁾ (7)	4 s ⁽⁴⁾ (7)	4 s ⁽⁴⁾ (7)
number of reverse operations		10000	10000	10000
operating (see page 52)				
use with supply R	permanent	■	■	■
	non permanent	■	■	■
reversing N → R				
normal voltage loss		time delayed by T1 0.1 to 30 s		
request of generator set running		only with standby generator set		
starting				
accurate voltage of the generator set				
load shedding order		after time delay T1 (+ starting time of generator set if necessary)		
opening of TN				
closing of TR		after 3 s (T3 adjustable up to 30 s)		
reversing R → N				
normal voltage return		time delayed by T2 10 to 180 s		
transfer order				
opening of TR				
load restoration order				
closing of TN		after 3 s (T4 adjustable up to 30 s)		

(1) Add an undervoltage release, or a shunt trip

characteristics automatic source changeover selection C101 to C1251/N/H/L

sequence of operations
C101 to C1251N/H/L
with Merlin Gerin
automatism

power source changeover equipment with standby generating set

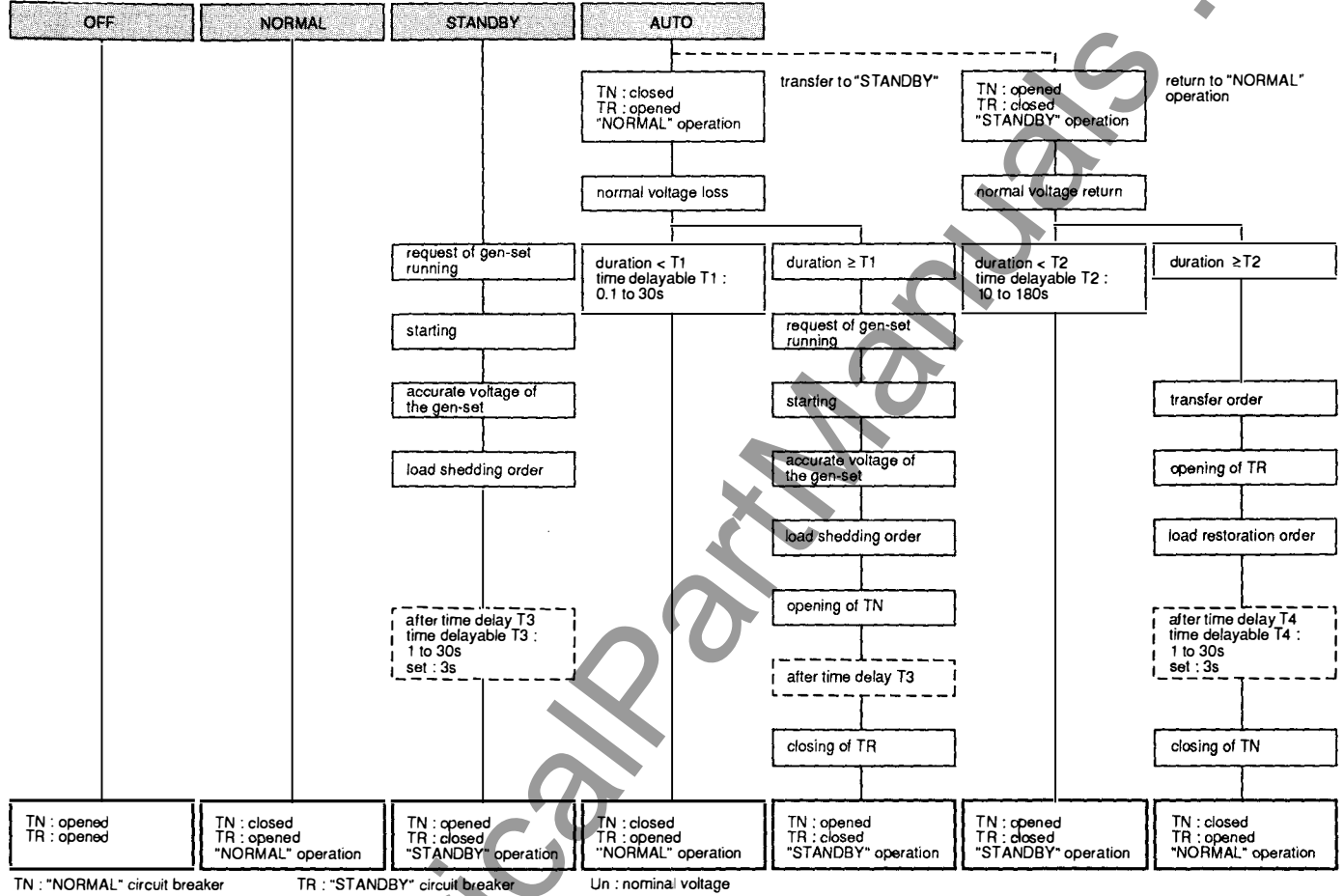

power source changeover equipment with permanent standby generating set

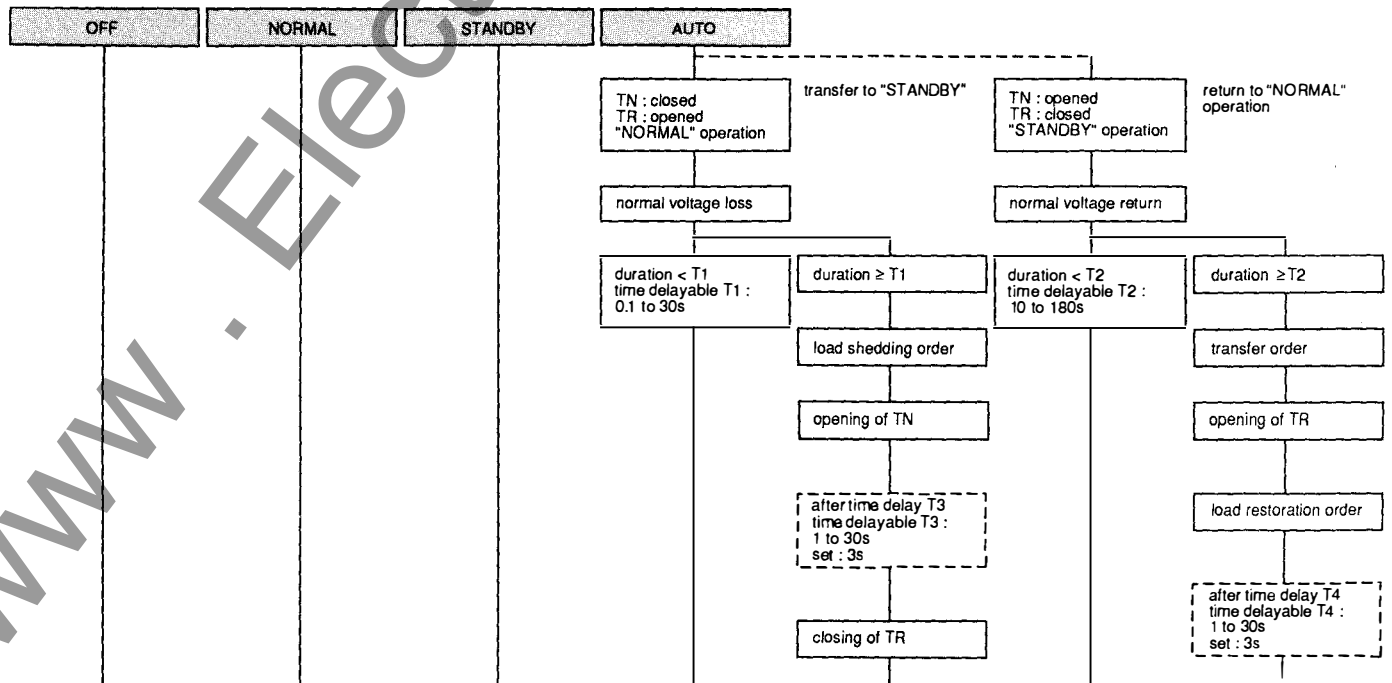

wiring diagram
(transfer switch without
Merlin Gerin automatism)

with 2 Compact C101 to C161N/H/L

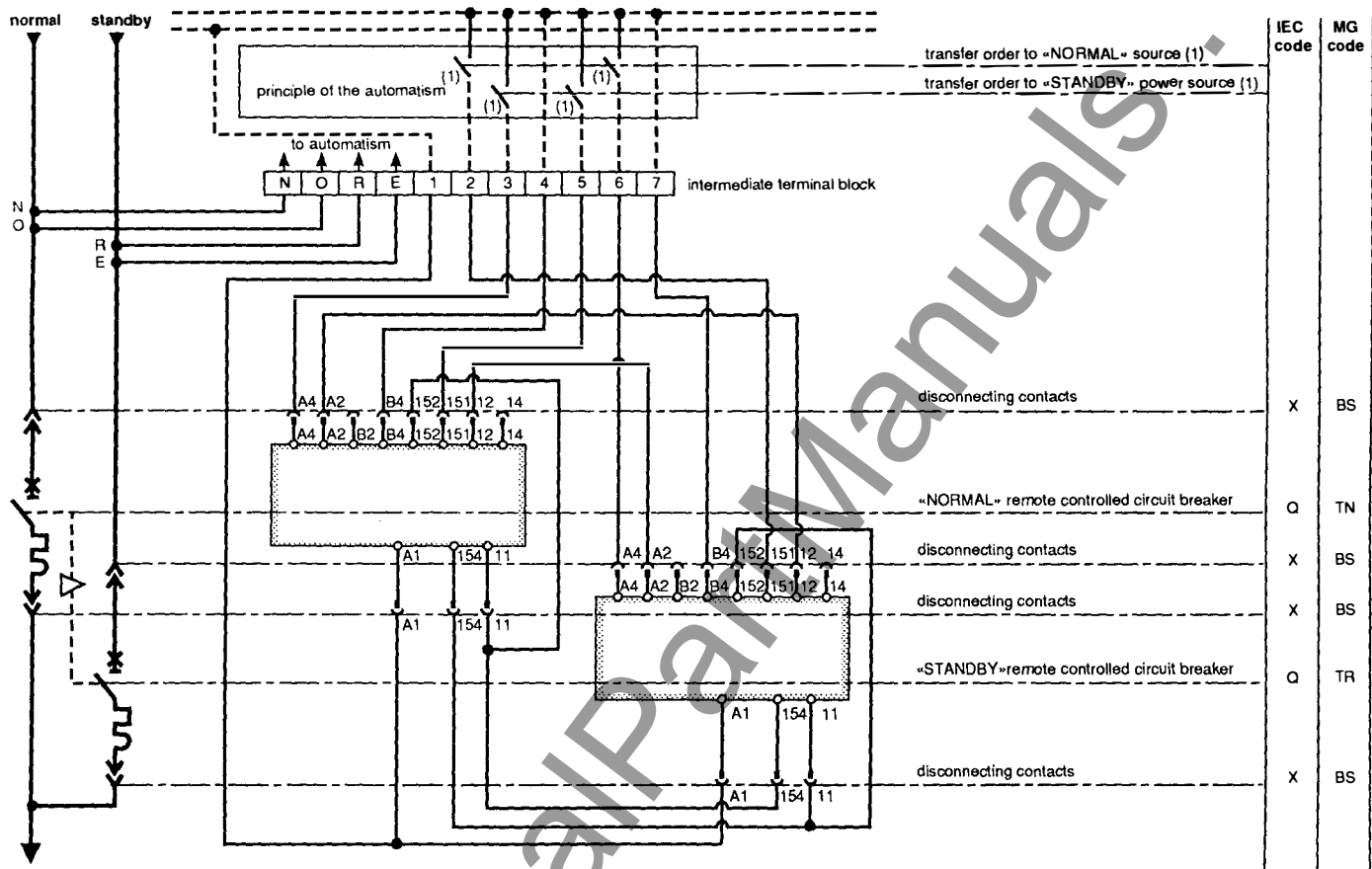

with 2 Compact C250 to C1251N/H/L

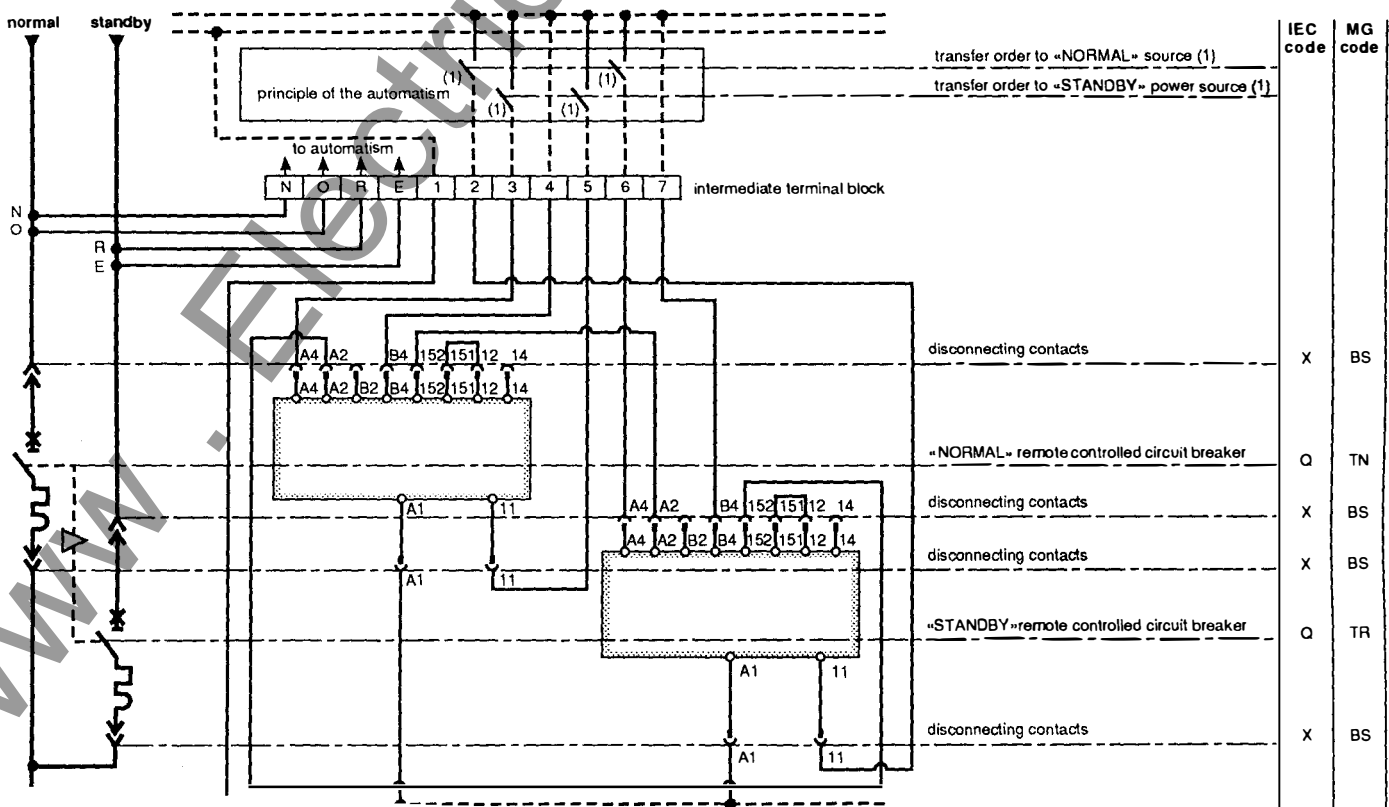

characteristics electrical auxiliaries

auxiliary switches voltage releases

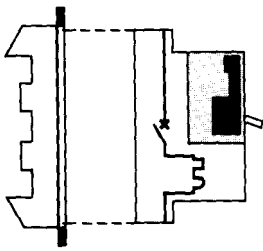

A range of auxiliary contacts shunt trips and undervoltage releases equips all the Compact circuit breakers and their derived products.

These auxiliaries are fitted inside the circuit breaker without any difficulty. Regarding particularly the Compact C100E to C600E and C101N/H/L to C1251N/H ST, these auxiliaries are fixed by a **simple ratcheting** without any risk of contact with the live parts.

Tropicalisation

All the auxiliaries are tropicalised all climates and comply with treatment 2 of the standard NF C 63-100.

auxiliaries contacts

OF contact
opening and closing



SD contact
for fault indication



OF contact double-throw switch used for a signal or a control linked with the "OFF" or "ON" position of the circuit breaker (signalling, electrical locking, relaying, etc.).

SD contact double-throw switch used for indication when the breaker opens on any fault. The SD contact operates on:

- **overcurrent** or **insulation fault** (Vigi module) trip.
- opening by **action of the voltage release** (MX or MN).

This contact reverts to its rest position when the circuit breaker is reset.

Characteristics

for Compact		C161 to C1251N/H/L	C101
rated current		2 A	2 A
breaking capacity	AC 220 V	5 A	1.5 A
	380 V	1.4 A	0.5 A
DC	24 V	2.8 A	2 A
	48 V	1 A	1.5 A
	110 V	0.3 A	0.7 A
	220 V	0.1 A	

SDE contact
for electrical fault indication

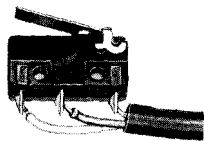

Normally closed contact, used for an indication when the breaker opens on an electrical fault.

The SDE contact only operates for an **overcurrent** or **insulation fault** (Vigi module) trip. It reverts to its rest position when the circuit breaker is reset.

Generally associated with T and TS type remote control units, it enables remote

resetting to be performed after opening by action of the voltage release (MX or MN).

Characteristics

for Compact		C250 to C1251N/H/L
rated current		2 A
breaking capacity	AC 220 V	5 A
	380 V	1.4 A
DC	24 V	2 A
	48 V	1 A
	220 V	0.15 A

CAM contact
with early break

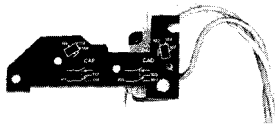

Double-throw switch used for a function linked with the "open" or "closed" position of the **rotary operating handle** or of the **Visu module** of the Compact C101 to C1251N/H/L.

Depending on the way it is fitted, the CAM contact operates with early make or early break.

Characteristics

for Compact		C101 to C1251N/H/L
rated current		2 A
breaking capacity	AC 220 V	5 A
	380 V	1.4 A
DC	24 V	2.8 A
	48 V	1 A
	110 V	0.3 A
	220 V	0.1 A

voltage releases

MX shunt trip release
MN undervoltage release



C101



C161 to C1251

The voltage releases are used for remote tripping of the circuit breaker:

- with **MX release**, by **shunt trip** in the control circuit (push-button, relay, etc.);
- with **MN release**, when the control circuit supply **voltage is absent** or drops below a **minimum threshold** (voltage failure, remote opening by push-button, relay, etc.).

Tripping by action of MX or MN release always requires resetting of the circuit breaker.

The MX release is equipped with a self-breaking contact which cuts its control circuit as soon as the circuit breaker is tripped. For a supply voltage U_n , this release operates for a voltage from 70 % to 110 % of U_n .

Operation of the MN release complies with the requirements of the standard IEC 947-2. For a supply voltage U_n :

- **opening** of the circuit breaker takes place for a voltage lower than or equal to 70 % of U_n (compulsory opening over 35 % of U_n).

■ **closing** of the circuit breaker becomes possible for a voltage equal to or greater than 85 % of U_n . For a voltage lower than or equal to 35 % of U_n , closing is prevented.

Characteristics

for Compact		C101	C161 to C1251
power supply = U_n	AC 50 Hz	see part number page 65	
	AC 60 Hz		
	DC		
MX pick-up consumption	AC (VA)	10	150
	DC (W)	6	150
opening time (ms)		≤ 50	≤ 50
MN seal-in consumption	AC (VA)	10	8
	DC (W)	6	5
opening time (ms)	instant. MN	≤ 50	≤ 50

connection of auxiliary

Plug-in Compact

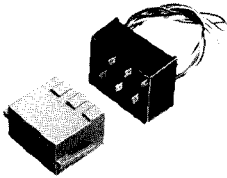

Auxiliary wire block
(fixed part and moving part)

Plug-in FC or RC Compact C101 to C1251N/H/L

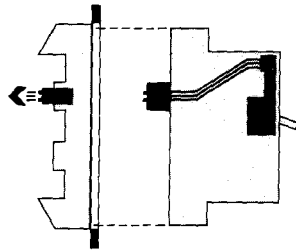

The auxiliary connections are output from the circuit breaker via 6-terminal or 3-terminal plug-in blocks depending on the auxiliary to be connected. These blocks **have numbered** terminals and comprise:

- a **moving part**, fixed onto the circuit breaker, and receiving the internal connections. These connections are identified by coloured wires;
- a **fixed part**, mounted on the plug-in base of the circuit breaker. This fixed part, which makes up the **terminal block**, directly receives the external connections (6.35 mm clips).

Fixed Compact



Auxiliary wire block for
fixed RC Compact

Fixed RC Compact C101 to C1251N/H/L

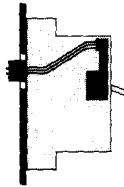

It is the moving part of the plug-in block, fixed onto the circuit breaker, which is used as the terminal block for direct connection of the external connections (6.35 mm clips).

Fixed FC Compact C101 to C1251N/H/L

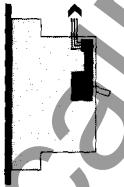

The external connections are connected directly to the auxiliary via the front panel, through a hole made after removing the pre-cut part of the cover. Each terminal is marked with a number (see diagram).

auxiliary equipment possibilities

The table hereunder indicates:
■ the type and quantity of auxiliaries which can be fitted at the same time on each Compact,

■ the type and quantity of plug-in blocks to be provided (for plug-in Compacts).
The sign + indicates the auxiliaries which can be fitted together on the same unit.

Peak possibilities

type of Compact	auxiliary contacts			auxil. wire block	+ trip unit options	voltage releases		auxil. wire block	motor mechanism		auxil. wire block
	OF	SD	SDE			MX	MN		T	TS	
C100E	1	+	1	without (fixed breaker)		+	1	without (fixed breaker)			
C225E	2			without (fixed breaker)		+	1 or 1	without (without breaker)			
C400E, C600E	1	+	1	without (fixed breaker)		+	1 or 1	without (without breaker)			
C101N/H/L, C161N/H/L	2			1 × 6 terminals		+	1 or 1	1 × 3 terminals		+ 1 or 1 ⁽³⁾	
C250N/H/L	2		+ 1 ⁽¹⁾	1 × 6 terminals		+	1 or 1	1 × 3 terminals		+ 1 or 1	1 × 6 terminals
C401N/H/L, C400N/H/L ST, C630N/H/L ST, C801N/H/L ST ⁽²⁾ , C1001N/H/L ST ⁽²⁾	1	+	1	1 × 6 terminals		+	1 or 1	1 × 3 terminals		+ 1 or 1	1 × 6 terminals
	3	+	1	1 × 6 terminals				1 × 3 terminals		+ 1 or 1	1 × 6 terminals

wiring diagrams

Compact C101 to C250N/HL

2 OF contacts

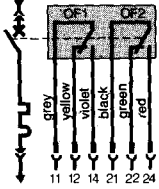

1 block of 6 terminals

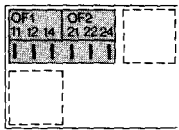

1 OF contacts + 1 contact SD

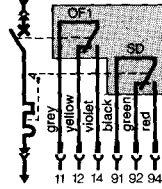

1 block of 6 terminals (back view)

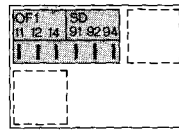

1 MX or MN voltage release

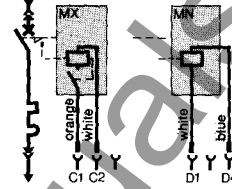

1 block of 3 terminals (back view)

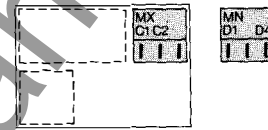

Compact C401 and C630N/H/L, C400 and C630N/H/L ST

1 OF contact + 1 SD contact

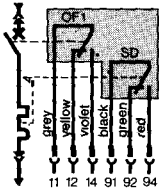

1 block of 6 terminals

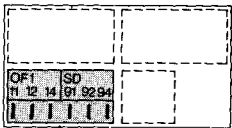

3 OF contacts + 1 contact SD

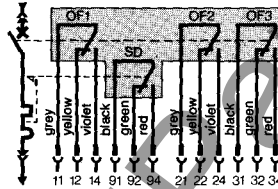

1 block of 6 terminals (back view)

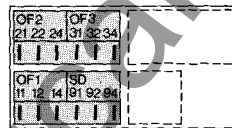

1 MX or MN voltage release

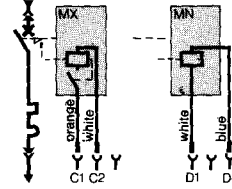

1 block of 3 terminals (back view)

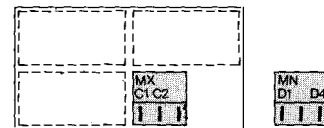

Compact C801 to C1251N/H ST

1 OF contact + 1 SD contact

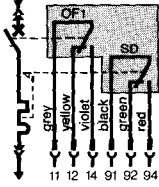

1 block of 6 terminals

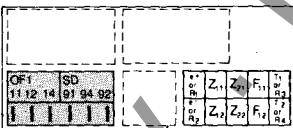

3 OF contacts + 1 SD contact

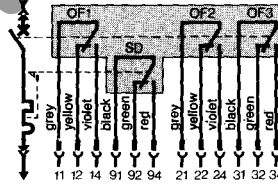

1 block of 6 terminals (back view)

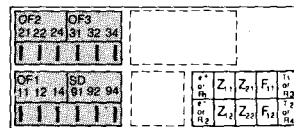

1 MX or MN voltage release

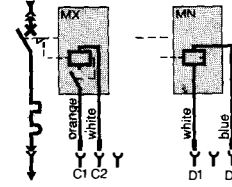

1 block of 3 terminals (back view)

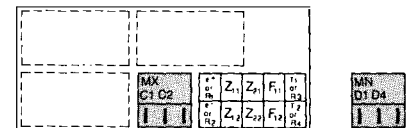

direct rotary handle

Dimensions: page 119

Direct rotary handle

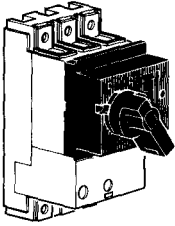

The direct rotary handle is available for all the Compact circuit breakers. It mainly consists of:

- an **adaptation frame** fitted on the Compact,
- a **toggle** always lockable by 3 padlocks (not supplied),
- a **driving system**, which links this toggle with the adaptation frame.

This handle can be transformed into an extended rotary handle by means of a set of accessories, supplied on option. The **positive break indication** is kept with the direct rotary handle.

Degree of protection: IP 40.

The direct rotary handle is fitted in place of the cover.

It can be optionally fitted with:

- a red toggle with a yellow escutcheon to comply with the VDE standard;
- a key lock (see "locking devices");
- a CAM contact with early break or make depending on fitting (see page 54).

Direct rotary handle MCC type

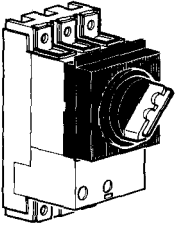

The direct rotary handle MCC type is designed for Compact C101 to C250N/H/L used in Motor Control Centers. It comes as a single part whose toggle is always lockable by 3 padlocks (not supplied). This handle cannot be fitted with any other accessory.

The **positive break indication** is kept with the MCC type direct rotary handle.

Degree of protection: IP 40.

extended rotary handle

Dimensions: page 119

With door locking

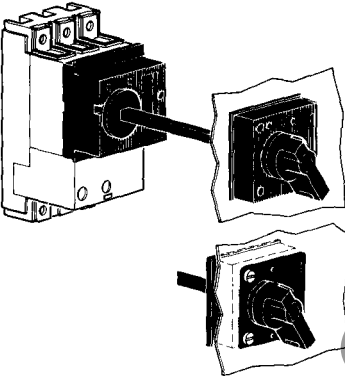

The extended rotary handle is made up of a direct rotary handle (see above), completed by:

- an **extension frame for fitting the toggle**,
- an **extension shaft** which exists in 2 models: short or long.

The **positive break indication** is kept with the extended rotary handle.

Degree of protection: IP 55.

The rotary handle and its extension frame can be fitted:

- either in front of the door,
- or behind the door.

In both cases, a locking device allows the door to be opened only when the circuit breaker is in the "OFF" position.

This rotary handle can be optionally fitted with the same accessories as the direct rotary handle.

Without door locking

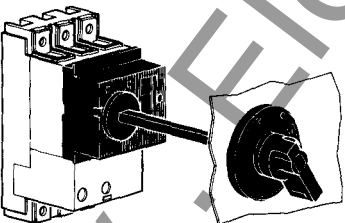

The extended rotary handle without door locking equips the Compact C101 to C1251N/H/L.

It comprises the same component parts as the rotary handle with door locking except for the following points:

- the extension frame is replaced by an escutcheon to support the toggle,
- the extension shaft only exists in the short model.

The **positive break indication** is kept with the extended rotary handle.

Degree of protection: IP 55.

This rotary handle can be optionally fitted with a key lock (see "locking devices").

Shaft bracket

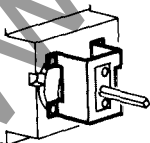

Designed for the rotary handle with extended shaft, this shaft bracket enables to eliminate the play of the shaft and to facilitate the operating of several rotary handles on the same door (systematically supplied for a long shaft).

locking devices

Removable locking devices

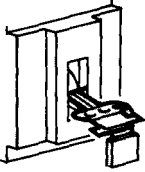

Compact C101 to C1251N/H/L with toggle padlocking device

For the Compact C101 to C1251N/H/L, there is a removable device for 3 padlocks (not supplied), which can be easily fitted when the operation takes place to lock the toggle in the "OFF" position.

Locking by padlock and key lock

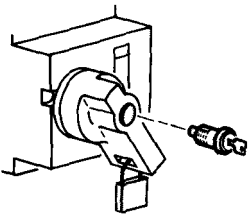

Locking for Compact C101 to C1251N/H/L

For Compact C101 to C1251N/H/L The safety locking devices require a rotary handle to be fitted in addition on the circuit breaker.
To lock the unit in the "OFF" position, this handle comprises:

- a padlocking device for 3 padlocks (not supplied), which is systematically incorporated in the toggle,
- a pre-drilled location, designed to accommodate 1 key lock supplied on option⁽¹⁾, whose key is captive when the unit is in the "ON" position

(1) Key locking cannot be fitted on the source changeovers.

interlocking devices

Dimensions: page 119

Mechanical interlock

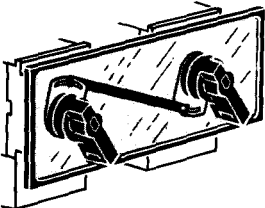

The mechanical interlock is achieved by a mechanism which combines 2 rotary handles to constitute a manual source changeover.

This device forbids the simultaneous closing of the 2 breakers but allows the opening.

The Compact C101 to C1251N/H/L are fixed normally on a panel or rails.

Interlocking by key locks

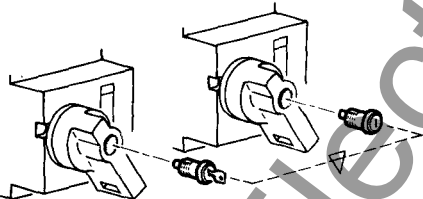

This interlocking is easily achieved by equipping each of the 2 Compact, either fixed or plug-in, with a standard key lock system, combining 2 key locks and a single key.

This solution enables 2 geographically distant units to be interlocked.

chassis locking devices (withdrawable versions)

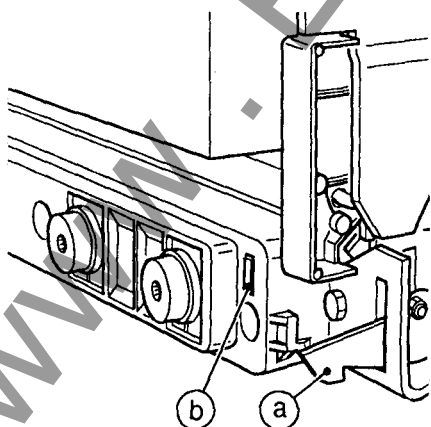

For withdrawable C161 to C1251N/H/L (standard chassis)

- fixed chassis can receive two kinds of locking devices, with supplied Ronis or Profalux locks (1 key):
 - locking in draw-out position
 - locking in draw-in and out positions.
- on standard version the chassis can be locked in draw-out position by 3 padlocks (not supplied)

For withdrawable C801 to C1251N/H ST (with universal chassis)

- disconnected and connected position locking: mounted on the frame and accessible with the cubicle door locked, the device for 1 or 2 Ronis or Profalux locks (not supplied) allows to lock the chassis: either in draw-out position only, or in

- 2 keylocks, one for locking of the chassis on either position (see above), the other one to prevent locking of the chassis.

Door interlock

Optional: Mounted on the frame, this lock prevents the cubicle door from being opened when the breaker is in the "connected" position. If the breaker is put into the "connected" position with the door open, the door can be closed without disconnecting the breaker.

Racking interlock

Optional: This lock prevents insertion of the breaker racking handle when the cubicle door is open. It can be defeated by pressing on the unlocking mechanism.

Sealing accessories



The sealing accessories are fitted in the holes provided on the front of the circuit breaker. They are ready to receive the steel wire and lead lock-pin (supplied with the set).

By means of these accessories:

- the circuit breaker cover can be sealed,
- access to the trip release unit settings can be prevented.

Note: the terminal shields are always supplied with their sealing accessories.

Label holder

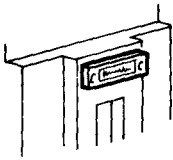

The label holder comprises a transparent cover in which a label is fitted marking the protected outgoer. It is fixed by means of self-tapping screws, in 2 holes provided for this purpose on the front of the Compact.

Locator for Compact type

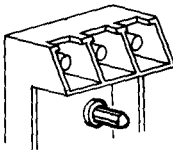

This locator is designed to avoid the plugging-in of a Compact N or H type in place of a Compact L type. This locator is fitted on the base of Compact C161 to C630L.

Terminal shields

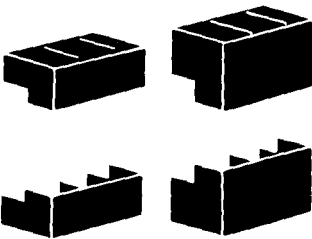

Short terminal shields Long terminal shields

These terminal shields are insulating, sealable accessories used to prevent direct contacts with live parts. The terminal shields are **compulsory**:

- in **plug-in version** (short terminal shields always supplied with the breaker).
- for **voltages > 500 V** (short or long terminal shields to be ordered separately).

According to the type of connection, the Compact can receive:

- either short terminal shields for fixed rear connection and plug-in version,
- or long terminal shields for fixed front connection version.

Fitting possibilities

Compact type		terminal short	shields long	extension
C101N/H/L	fixed FC		■	
C161N/H	fixed RC	■		
to C125N/H	plug-in			
C400L	FC/RC	■		
to C1001L				
C161L,	fixed FC		■	■
C250L	fixed RC	■		
	plug-in			
	FC/RC	■		

Spacing support

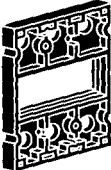

The spacing support enables:

- either to align the front face of fixed Compact C101N/H/L with the other Compact.

A long rear connection has to be used for a fixed RC C101N/H/L when using the spacing support ref. 39991.

- either to replace a fixed FC C125N/H/L by a C101 N/H/L.

door frames and cut-out grommets

Fixed versions
Door cut-out grommet

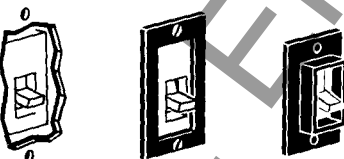

Before fitting the grommet After fitting the grommet for fixed circuit breaker After fitting the grommet for plug-in circuit breaker

The grommet is a moulded part which is fitted on the door by simple riveting. It enables a door cut roughly without special finishing to be used. It is available for C100E to C600E and C101 to C1251N/H/L

Tight bellows



The bellows ensures the tightness of the toggle (IP 43) when operation is performed via a door or an escutcheon. It is fitted on the front of the Compact C225 to C600E and C101 to C630N/H/L with direct handle.

characteristics installation

withdrawable versions C161N/H/L to C1251N/H ST (standard chassis)

Watertight escutcheon

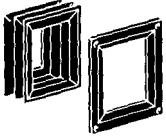

For C161 to C630N/H/L the escutcheon ensures the tightness of the handle (IP 40) when the control is achieved through a door in connected/disconnected position. It is mounted on the door.

Door frames

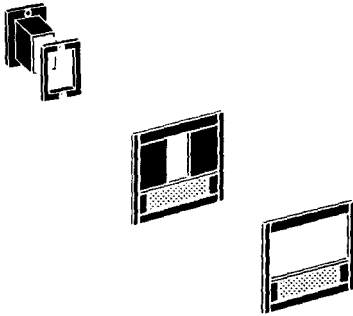

For C801N/H/L ST to C1251N/H ST, front door can be fitted to reach IP 40:

- a standard door cut-out grommet
- or a door frame with a porthole to show the trip unit setting and signalisation, and a door cut-out grommet (2 versions: direct toggle and rotary handle).

withdrawable versions with universal chassis (C801N/H/L ST to C1251N/H ST)

Door frames

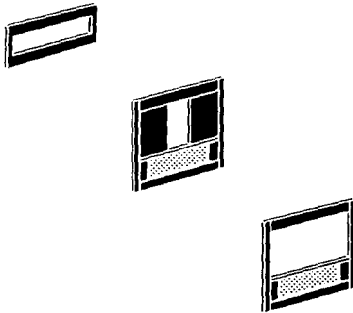

The IP 40 fitting is:

- a door frame for chassis (lower part of the breaker),
- and a door frame with a porthole to show the trip unit setting and signalisation, and a door cut-out grommet (2 versions: direct toggle and rotary handle).

accessories for withdrawable C161N/H/L to C1251N/H ST

Connected/disconnected position carriage switches

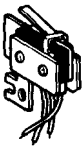

For C161 to C1251N/H/L, micro-switches are available for the fixed chassis of the drawout circuit breaker, indicating connected or disconnected position.

The disconnected position is indicated only when the minimum isolating distance between fixed and moving disconnecting contacts has been reached.
Contacts characteristics:
breaking capacity
5 A/250 V AC, 2 A/24 V DC,
0.15 A/220 V DC

Connection set of auxiliaries

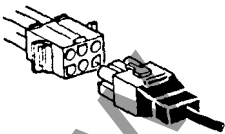

The connection set allows to check the auxiliaries circuits when the breaker is in the disconnected position.
It is possible to fit 1 or 2 connection sets (6 pins).

connection:
 Compact C100E to C600E
 Compact C101 to C630N/H/L
 Compact C400 and
 C630N/H/L ST

Compact C101 to C630N/H/L, C400 and C630N/H/L ST

direct connection

By bars, or cables with crimped lugs

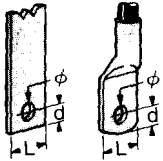

fixed FC

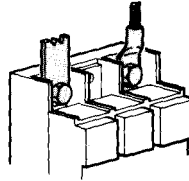

fixed RC

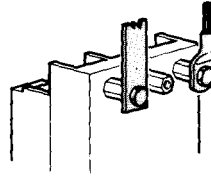

plug-in FC⁽²⁾

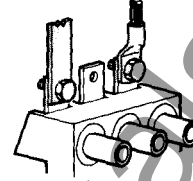

plug-in RC⁽²⁾

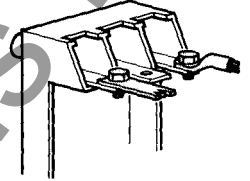

possible dimensions of bars or crimped cable-lugs (mm)

		C100E C101N/H/L	C161N/H/L	C225E	C250N/H/L	C400/C600E C401/C630N/H/L C400/C630N/H/LST
bars	L	16	25	25	30	40 ⁽¹⁾
	d	8	11	11	15	20
	∅	6.5	6	8	10	12
crimped lugs	L	16	25	25	30	40
	∅	6.5	6	8	10	12 ⁽¹⁾

connection with accessories

with connectors for bare cables

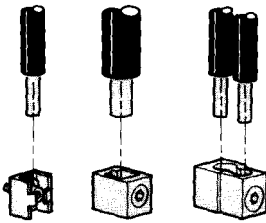

fixed FC

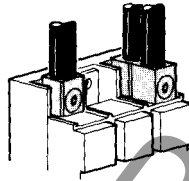

plug-in FC

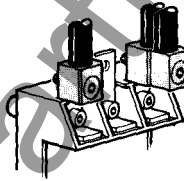

plug-in RC

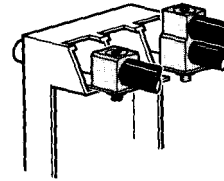

possible dimensions of cable cross-section (mm²)

connector	C100E C101N/H/L	C161N/H/L	C225E	C250N/H/L	C400/C600E C401/C630N/H/L C400/C630N/H/LST
single		2.5 to 16 [□]			
double		1.5 to 70 [□] built-in	16 to 95 [□]	2.5 to 95 [□] 50 to 150 [□]	16 to 185 [□]
		2 cables 70 to 240 [□]			

Angle terminals



fixed FC

by bars,
or crimped lugs

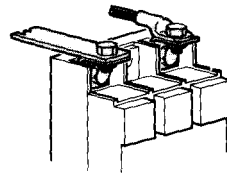

with connectors
for bare cables

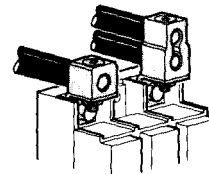

spreader

for C401 and C630N/HL
for C400 and C630N/H/L ST

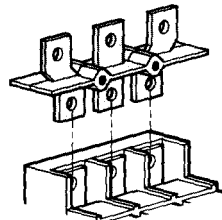
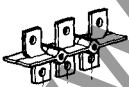

The spreader, intended for the C401 and C630N/H/L, C400 and C630N/H/L ST, enables the pole distance to be increased for easier connections.

It allows a width of 60 mm busbars and crimped cable-lugs (compared with a width of 40 mm for direct connection). The spreader takes the same accessories as the direct connection.

characteristics installation Compact

connection:
Compact C801 to
C1251N/H ST

Compact C801 to C1251N/H ST

direct connection

By flat or edgewise bars

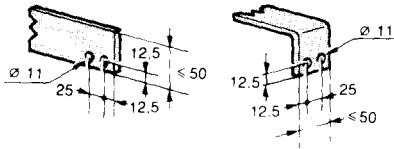

fixed FC

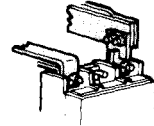
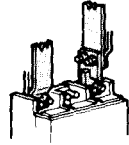

fixed RC



plug-in RC

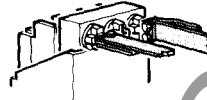
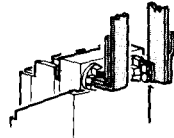

connection with accessories

With connectors for bare cables

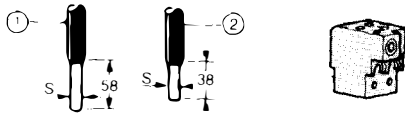

fixed FC

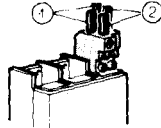

With complementary terminal pads
for cables with crimped lugs

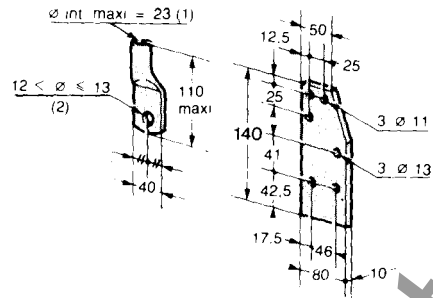

fixed FC

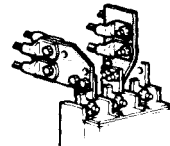
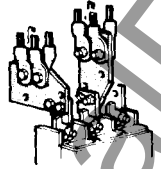

fixed RC

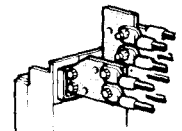
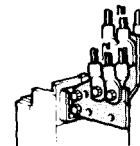

plug-in RC

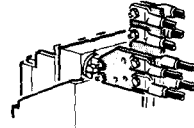
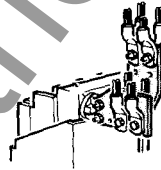

www.ElectricalPartManuals.com

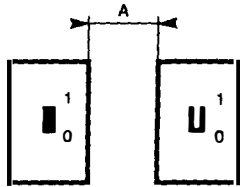

minimum distance between 2 breakers side by side $A = 0$

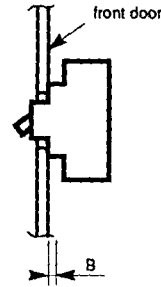

minimum distance between 2 breakers and front door $B = 0$

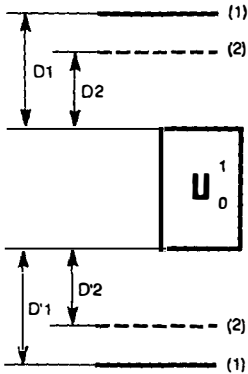

(1) blank metal plate
(2) painted metal or insulated plate, insulated bar

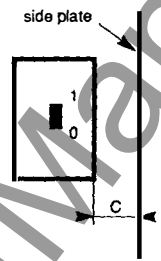

minimum distance between 2 breakers and blank side plate C
($C = 0$ for insulated or painted side plate)

Distance $D1$ and $D'1$ are obtained from tests defined in IEC 947.2. They are related to the ultimate breaking capacities for voltages from 220 to 660 V. (Note: for voltages > 480 V terminal shields are compulsory). They start from the frame of the breaker.

circuit breaker		D1 mm	D2 mm	D'1 mm	D'2 mm	C mm
TC40	N	20	20	20	20	5
	L	20	20	20	20	5
C101	N/H	20	20	20	20	5
	L	20	20	40	40	5
C161	N/H	40	40	20	20	5
	L	50	50	50	50	5
C250	N/H	30	30	30	30	10
	L	30	30	60	60	10
C400	N/H	130 ⁽¹⁾	100 ⁽¹⁾	60	60	10
C401	L	130	100	130	100	10
C630						
C801	N/H	130	100	70	70	10
C1001	L	130	100	130	100	10
C1251						
CM1250 to CM3200	N/H	100	100	100	100	20

(1) For the N/H versions where phase separators are compulsory distances start from the frame of the breaker.



www.ElectricalPartManuals.com



Compact 11 to 1250 A

3 part numbers

	page
Compact mccb's and models, auxiliaries and accessories	
Compact C100E to C600E	66
Compact C100NF	66
Compact TC40N/L	68
Compact C101N/H/L	70
Compact C161N/H/L	74
Compact C250N/H/L	78
Compact C401N/H/L	82
Compact C400N/H/L ST	84
Visucompact C400N	86
Visucompact C401N ST	
Compact C630N/H/L	88
Compact C630N/H/L ST	90
Visucompact C630N	92
Visucompact C630N ST	
Compact C801N/H/L ST	94
Compact C1001N/H/L ST	95
Compact C1251N/H ST	96
ST trip units for Compact C801N/H/L ST to C1251N/H ST	96
Visucompact C801N ST to C1251N ST automatic and manual source changeover	100 101

part numbers
C100E to C600E
C100NF

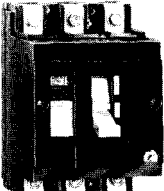
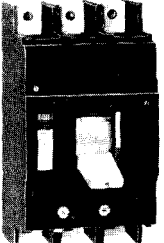
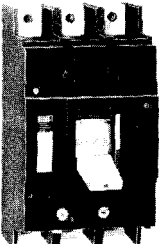
Compact mccb's C100E to
C600E, C100NF

complete breaker...			... consisting of:				
	fixed FC	rating	3P 3t				
		15	40101				
		20	40102				
		30	40103				
		40	40104				
		50	40105				
		60	40106				
		80	40107				
100	40108						
	fixed FC	rating	3P 3t				
		125	43460				
		150	43461				
		175	43462				
		200	43463				
	225	43464					
	fixed RC	125	■		≡ C225E fixed FC + 1 set of rear connections per pole 41190		
		150	■		≡ C225E fixed FC + 1 set of rear connections per pole 43472		
175 to 225		■					
	fixed FC	rating	3P 3t				
		250	44490				
		300	44491				
		350	44492				
	400	44493					
	fixed RC	250 to 400	■		≡ C400E fixed FC + 1 set of rear connections per pole 44800		
			fixed FC		rating	3P 3t	
					500	45450	
600			45451				
fixed RC	500		■	≡ C600E fixed FC + 1 set of rear connections per pole 44800			
	600		■				
			fixed FC		rating	1P 1t	
		15			40010		
20		40011					
30		40012					
40		40013					
50		40014					
60		40015					
80		40016					
100	40017						

www.ElectricalPartManuals.com

electrical auxiliaries	C100E	C225E	C400E C600E	C100NF (1P)
auxiliary double-throw switches				
 1 OF	40036			
2 OF		42901		
1 SD	40037			
1 OF + 1 SD		42902	44900	
3 OF + 1 SD			44901	
voltage release (for remote tripping)				
 MX (shunt trip)				
AC 50/60 Hz or DC ⁽¹⁾ (V)				
24		42910	44910	
48/60		42911	44911	
110/130	40031 ⁽¹⁾	42912	44912	
220/240	40032 ⁽¹⁾			
220/300		42913	44913	
380/415	40033 ⁽¹⁾			
380/480	40034 ⁽¹⁾	42914	44914	
 MN (undervoltage release)				
AC 50 Hz (V) ⁽²⁾				
110/127	40044	42920	44925	
220/240	40045	42921	44926	
380/415	40046	42922	44932	
440/480	40043	42927		
AC 60 Hz (V) ⁽²⁾				
110/127	⁽²⁾	42931	44925	
220/240	⁽²⁾	42928	44926	
440	⁽²⁾	42933	44649	
DC (V)				
24	40047	42923	44923	
48	40048	42924	44924	
110/130	40049	42925	44925	
250	40050	42926	44926	
accessories				
locking by padlocks or key lock				
 of the toggle (in open position) by 3 padlocks (not supplied)	44936	44936	44936	44936
circuit label holder				
 pack of 10	42976	42976	42976	
cutout grommet				
 for door	42977	42977	44938	
tight bellows				
 for toggle (IP43)		41318	44965	
sealable terminal shields				
 short term. shields (1 set) 3P	3X40041 ⁽³⁾	42960	44829	40041
 long term. shields (1 set) 3P	40040	42962	44831	
phase separators				
rating 125 A to 150 A		42964		
rating 175 A to 225 A		43470		
connection (see p. 61)				
connectors for bare cable				
 single connectors per pole for 1 cable 70 ² ≤ S ≤ 300 ²			44813	
double connector per pole for 2 cable 70 ² ≤ S ≤ 240 ²			44814	
1 set of 3 connectors				
rating 125 A to 150 A		41184		
rating 175 A to 225 A with phase separators		43473		

part numbers TC40N/L

Compact TC40N/L



Compact TC40N

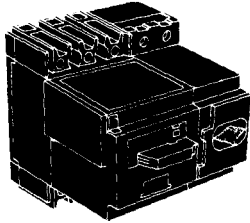

power supply

AC 50 Hz

AC 60 Hz

DC

rating	3P 3t	4P 4t	3P 3t	4P 4t	3P 3t	4P 4t	
D10	110 V	22350	22450	120 V	22350	22450	
	127 V	22351	22451	240 V	22352	22452	
	220 V	22352	22452	440 V	22354	22454	
	240 V	22353	22453	480 V	22355	22455	
	380 V	22354	22454				
D16	110 V	22370	22470	120 V	22370	22470	
	127 V	22371	22471	240 V	22372	22472	
	220 V	22372	22472	440 V	22374	22474	
	240 V	22373	22473	480 V	22375	22475	
	380 V	22374	22474				
D25	110 V	22390	22490	120 V	22390	22490	
	127 V	22391	22491	240 V	22392	22492	
	220 V	22392	22492	440 V	22394	22494	
	240 V	22393	22493	480 V	22395	22495	
	380 V	22394	22494				
D32	110 V	22410	22510	120 V	22410	22510	
	127 V	22411	22511	240 V	22412	22512	
	220 V	22412	22512	440 V	22414	22514	
	240 V	22413	22513	480 V	22415	22515	
	380 V	22414	22514				
D40	110 V	22430	22530	120 V	22430	22530	
	127 V	22431	22531	240 V	22432	22532	
	220 V	22432	22532	440 V	22434	22534	
	240 V	22433	22533	480 V	22435	22535	
	380 V	22434	22534				
415/440 V	22355	22455					
					24 V	22360	22460
					48 V	22361	22461
					110 V	22362	22462
					125 V	22363	22463
					220 V	22364	22464
					250 V	22365	22465
					24 V	22380	22480
					48 V	22381	22481
					110 V	22382	22482
					125 V	22383	22483
					220 V	22384	22484
					250 V	22385	22485
					24 V	22400	22500
					48 V	22401	22501
					110 V	22402	22502
					125 V	22403	22503
					220 V	22404	22504
					250 V	22405	22505
					24 V	22420	22520
					48 V	22421	22521
					110 V	22422	22522
					125 V	22423	22523
					220 V	22424	22524
					250 V	22425	22525
					24 V	22440	22540
					48 V	22441	22541
					110 V	22442	22542
					125 V	22443	22543
					220 V	22444	22544
					250 V	22445	22545

Compact TC40L

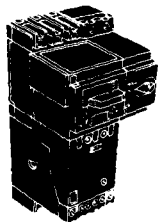

rating	3P 3t	4P 4t
D10	■	■
D16	■	■
D25	■	■
D32	■	■
D40	■	■

...consisting of:

- TC40N (see above)
- + 1 limiter block **22035**
- + 1 neutral block (for 4P breaker) **22036**
- + 1 mounting plate⁽¹⁾ **22130**

Vigicomact TC40N REH

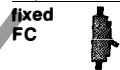
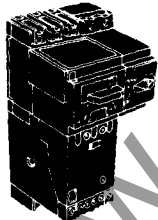

rating	3P 3t	4P 4t
D10	■	■
D16	■	■
D25	■	■
D32	■	■
D40	■	■

- TC40N (see above)
- + 1 Vigi clock REH 40 3P **22300**
- + 1 neutral block (for 4P breaker) **22302**
- + 1 mounting plate⁽¹⁾ **22130**

individual enclosures

individual enclosure	IP40
3 poles	22136



electrical auxiliaries

auxiliary double-throw switches

for Compact TC40N

1O + 1F	22120
2O + 2F	22121

for Compact TC40L

or Viglcompact TC40N REH

1O + 1F	22122
2O + 2F	22123
1SD + 1SDM	22127



voltage releases

MN (instantaneous undervoltage release)

AC 50 Hz	110 V	22162
	127 V	22163
	220 V	22165
	240 V	22166
	380 V	22167
AC 60 Hz	415/440 V	22168
	120 V	22162
	208 V	22164
	240 V	22165
DC	480 V	22168
	24 V	22170
	48 V	22171
	60 V	22172
	110/125 V	22173



MNR (undervoltage release with time delay)

AC 50 Hz	110 V	22182
	127 V	22183
	220 V	22185
	240 V	22186
	380 V	22187
AC 60 Hz	415/440 V	22188
	120 V	22182
	208 V	22184
	240 V	22185
	480 V	22188



low level input converters

24 V DC	22140
48 V DC	22141
127 V DC	22142



accessories

mounting plates

for separate limiter block	22131
for adaptation of C40L or C40 REH ⁽¹⁾	22130



mechanical alarm

SDM	22126
-----	-------



codage pins	22138
-------------	-------

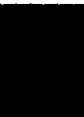

www.Elcomsoft.com

part numbers C101N/H/L

Compact mccb's C101N/H/L:
with D type trip unit



		complete breaker...					...consisting of:
		rating	2P 2t	3P 3t	4P 3t	4t	3t + N/2
	fixed FC	15	38500	38510	38520	38530	
		25	38502	38512	38522	38532	
		40	38503	38513	38523	38533	
		63	38505	38515	38525	38535	
		80	38506	38516	38526	38536	
		100	38507	38517	38527	38537	
	fixed RC	15	38550	38560	38570	38580	= C101N fixed FC + 1 set of rear connections (1) per pole 39998
		25	38552	38562	38572	38582	
		40	38553	38563	38573	38583	
		63	38555	38565	38575	38585	
		80	38556	38566	38576	38586	
		100	38557	38567	38577	38587	
	plug-in FC RC	15	38600	38610	38620	38630	= C101N fixed FC + 1 set of plugs per pole 39985 + 1 plug-in base FC/RC 2P 39972 3P 39973 4P 39974 + 1 set of short term. shields 2P/3P 39983 4P 39984
		25	38602	38612	38622	38632	
		40	38603	38613	38623	38633	
		63	38605	38615	38625	38635	
		80	38606	38616	38626	38636	
		100	38607	38617	38627	38637	
	fixed FC	15	38660	38670	38680		
		25	38662	38672	38682		
		40	38663	38673	38683		
		63	38665	38675	38685		
		80	38666	38676	38686		
		100	38667	38677	38687		
	fixed RC	15	38710	38720	38730		= C101H fixed FC + 1 set of rear connections (1) per pole 39998
		25	38712	38722	38732		
		40	38713	38723	38733		
		63	38715	38725	38735		
		80	38716	38726	38736		
		100	38717	38727	38737		
	plug-in FC RC	15	38760	38770	38780		= C101H fixed FC + 1 set of plugs per pole 39985 + 1 plug-in base FC/RC 3P 39973 4P 39974 + 1 set of short term. shields 3P 39983 4P 39984
		25	38762	38772	38782		
		40	38763	38773	38783		
		63	38765	38775	38785		
		80	38766	38776	38786		
		100	38767	38777	38787		
	fixed FC	15	38810	38820	38830		
		25	38812	38822	38832		
		40	38813	38823	38833		
		63	38815	38825	38835		
		80	38816	38826	38836		
		100	38817	38827	38837		
	fixed FC	15	39720	39730	39740		= C101L fixed FC + 1 set of rear connections (1) per pole 39998
		25	39722	39732	39742		
		40	39723	39733	39743		
		63	39725	39735	39745		
		80	39726	39736	39746		
		100	39727	39737	39747		
	plug-in FC RC	15	38860	38870	38880		= C101L fixed FC + 1 set of limiter plugs per pole 39992 + 1 plug-in base FC/RC 3P 39973 4P 39974 + 1 set of short term. shields 3P 39983 4P 39984
		25	38862	38872	38882		
		40	38863	38873	38883		
		63	38865	38875	38885		
		80	38866	38876	38886		
		100	38867	38877	38887		

WWW.ELECTRICALS.COM



Vigicompact mccb's C101N/H/L Compact mccb's C101N/H/L with Vigirex RCD remote control units

Vigicompact C101N REH*

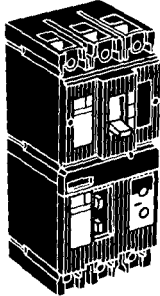

		complete breaker...				...consisting of:		
		rating	3P 3t	4P 3t	4t	3t+N/2		
fixed FC		15	38910	38920	38930		= C101N fixed FC + 1 Vigi module REH 101	
		25	38912	38922	38932			3P 39944 4P 39945
		40	38913	38923	38933			
		63	38915	38925	38935			
		80	38916	38926	38936			
		100	38917	38927	38937			
fixed RC		15 to 100	■	■	■		= C101H REH fixed FC + 1 set of rear connections ⁽¹⁾	
plug-in RC		15 to 100	■	■	■		= C101N REH fixed FC + 1 set of Vigi plugs + 1 plug-in base FC/RC + 1 set of short term. shields	

Vigicompact C101H REH*

fixed FC		15 to 100	■	■	■		= C101H fixed FC + 1 Vigi module REH 101
fixed RC		15 to 100	■	■	■		= C101H REH fixed FC + 1 set of rear connections ⁽¹⁾
plug-in RC		15 to 100	■	■	■		= C101H REH fixed FC + 1 set of Vigi plugs + 1 plug-in base FC/RC + 1 set of short term. shields

Vigicompact C101L REH*

fixed FC		15 to 100	■	■	■		= C101L fixed FC + 1 Vigi module REH 101
fixed RC		15 to 100	■	■	■		= C101L REH fixed FC + 1 set of rear connections ⁽¹⁾
plug-in RC		15 to 100	■	■	■		= C101L REH fixed FC + 1 set of Vigi limiter plugs + 1 plug-in base FC/RC + 1 set of short term. shields

Vigicompact C101N/H/L RMM*

fixed FC		15 to 100	■	■	■		= C101N/H/L same versions as for Vigicompact REH + 1 Vigi module RMM 101
fixed RC		15 to 100	■	■	■		
plug-in RC		15 to 100	■	■	■		

Compact C101N/H/L with a Vigirex RCD and a separate toroid

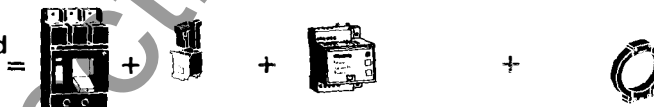

Compact fixed or plug-in (see page before)	voltage release (see page electrical auxiliaries)	Vigirex RCD	toroidal sensor	shielded wire (2 conductors) l=100 m
		RH50 220/240V	TNØ30 plug-in	50105
		220/240V inherent safety model	PNØ50	50106
		RH53A 220/240V		
		380/415V		
				50136

remote control unit T101®

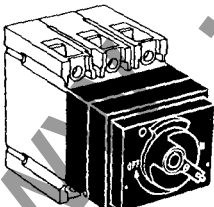

complete unit...				...consisting of:			
voltage (V)	AC 50 Hz	AC 60 Hz	DC	= 1 adaptation plate + 1 motor unit			
24/30			39858				
48/60			39859				
110/127	39850	39855	39860	voltage (V)	AC 50 Hz	AC 60 Hz	DC
220/240	39851	39856		24/30			39800
250			39861	48/60			39801
380/415	39853			110/127	39806	39810	39802
440	39854	39853		220/240	39807	39811	
				250			39803
				380/415	39808		
				440	39809	39808	











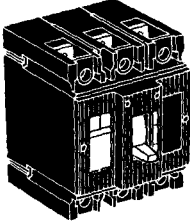

accessories for T101/T161® (remote control unit)

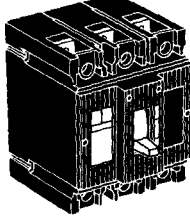
plug-in wiring and auxiliaries	39818	IBN low level input converter	
keylocking device	39820	OF version (continuous signal)	
accessories for sealing in automatic position	39829	24 V DC	39824
		48 V DC	39825
		220/240 V AC	39826
		X version (impulse signal)	
		24 V DC	39827
		48 V DC	39828

part numbers C101N/H/L (continued)

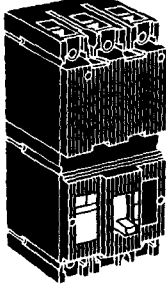
Compact mccb's C101N/H/L G and MA type





		complete breaker...		consisting of:					
		rating	3P 3t	4P 3t	4t					
Compact C101N type G* 	fixed FC		G15	39360		39380				
			G25	39362		39382				
			G40	39363		39383				
			G63	39365		39385				
			G80	39366		39386				
			G100	39367		39387				
	fixed RC		G15 to G100	■		■	= C101N type G fixed FC + 1 set of rear connections (1) per pole 39998			
			plug-in FC RC		G15 to G100	■		■	= C101N type G fixed FC + 1 set of plugs per pole 39985 + 1 plug-in base FC/RC 3P 39973 4P 39974 + 1 set of short term. shields 3P 39983 4P 39984	
	Compact C101H type MA 	fixed FC				MA2,5	39410			
						MA6,3	39411			
						MA12,5	39412			
						MA25	39413			
			MA50	39414						
MA100			39415	39425 ⊕						
fixed RC			MA150	39416 ⊕	39426 ⊕					
			MA2,5	39460			= C101H type MA fixed FC + 1 set of rear connections (1) per pole 39998			
			MA6,3	39461						
			MA12,5	39462						
			MA25	39463						
plug-in FC RC			MA50	39464						
			MA100	39465	39475 ⊕					
	MA150		39466 ⊕	39476 ⊕						
	MA2,5		39510			= C101H type MA fixed FC + 1 set of plugs per pole 39985 + 1 plug-in base FC/RC 3P 39973 + 1 set of short term. shields 3P 39983 4P 39984				
	MA6,3		39511							
	MA12,5		39512							
	MA25		39513							
fixed FC		MA50	39514							
		MA100	39515	39525 ⊕						
		MA150	39516 ⊕	39526 ⊕						
		Compact C101L type MA 	fixed FC		MA2,5	39560				
					MA6,3	39561				
					MA12,5	39562				
					MA25	39563				
MA50	39564									
MA100	39565				39575 ⊕					
fixed RC			MA150	39566 ⊕	39576 ⊕					
			MA2,5	39610			= C101L type MA fixed FC + 1 set of rear connections (1) per pole 39998			
			MA6,3	39611						
			MA12,5	39612						
			MA25	39613						
plug-in FC RC			MA50	39614						
			MA100	39615	39625 ⊕					
		MA150	39616 ⊕	39626 ⊕						
		MA2,5	39660			= C101L type MA fixed FC + 1 set of limiter plugs per pole 39992 + 1 plug-in base FC/RC 3P 39973 4P 39974 + 1 set of short term. shields 3P 39983 4P 39984				
		MA6,3	39661							
		MA12,5	39662							
		MA25	39663							
fixed FC		MA50	39664							
		MA100	39665	39675 ⊕						
		MA150	39666 ⊕	39676 ⊕						

Compact mccb's C101N/H/L auxiliaries, accessories, connection, spare parts

electrical auxiliaries



auxiliary double-throw switches		
	1 OF	40036
	2 OF	2 × 40036
	1 OF + SD	40036 + 40037
	1 CAM (for rotary handle)	39981

voltage release (for remote tripping)			
	MX (shunt trip)		
	AC 50/60 Hz (V)	DC (V)	
	110/130	40031	24 40029
	220/240	40032	48 40030
	380/415	40033	110/125 40028
	440/480	40034	250 40026

	MN (undervoltage release)		
	AC 50/60 Hz (V)	DC (V)	
	110/130	40044	24 40047
	220/240	40045	48 40048
	380/415	40046	110/130 40049
	440/480	40043	250 40050
	MN (with time delay relay)		
	220 V 50/60 Hz		
	= MN 110/130 V		40049
	+ time delay relay		
	250/700 ms		+ 40042

auxiliary wire block (see quantity p. 55)		
	moving part	
	short wires	3 term. 42942
	for types N/H/L	6 term. 42943
	fixed part	
	for all types	3 term. 42940
		6 term. 42941
	pack of 24 female clips	42946

accessories

direct rotary handle	
	standard
	with black toggle 39980
	red toggle only 42891
	watertight escutcheon (CNOMO) 42892
	MCC type 39979

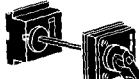
extended rotary handle	
	with door locking
	front door mounting
	short shaft 39977
	(= 39980 + 42882)
	long shaft 39978
	(= 39980 + 42884)
	rear door mounting
	short shaft 39953
	(= 39980 + 42889)
	long shaft 39954
	(= 39980 + 42897)

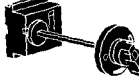
without door locking	
	front door mounting
	short shaft 39976
	(= 39980 + 45853)

accessories for converting direct rotary handle to extended handle	
	with door locking
	front door mounting
	short shaft 42882
	long shaft 42884
	rear door mounting
	short shaft 42889
	long shaft 42897

without door locking	
	front door mounting
	short shaft 45853

shaft bracket	
	for short shaft (always included on rotary handles with long shaft) 42868

locking by padlocks or key lock	
	of the rotary handle (circuit breaker in OFF position)
	by 3 padlocks built-in
	1 Ronis key lock 1351.500 41940
	1 Profalux key lock 42888
	KS5 B24 D4Z

of the toggle (in OFF position)	
	by 3 padlocks 44936

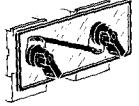
mechanical interlocking (for breakers with rotary handle)	
	mechanical device 44826

key locks interlocking (for breakers with rotary handle)	
	1 set of 2 Ronis 1351.500 41950
	key locks (1 single key)
	1 set of 2 Profalux 42878
	KS5 B24 D4Z key locks (1 single key)



sealing accessories

	for release, adjustment, cover 39970
---	--------------------------------------

circuit label holder	
	pack of 10 42976

cut-out grommet	
	for door 42977
	for T101/T161 39865

tight bellows	
	for toggle (IP43) 39969

sealable terminal shields	
	short term. shields 2P/3P 39983
	4P 39984
	long term. shields 2P/3P 39994
	4P 39995
	protective shield 2P/3P/4P 42968
	for plug-in base

spacing support	
	enables to aligne 2P/3P 39993
	the front face of 4P 39999
	a fixed C101N/H/L with other Compact
	1 set of long rear connections 39991

connection (see p. 61)

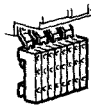
Polybloc terminal (for bare cables)	
	6 cables $S \leq 10^2$ 07100

spare parts

	cover 2P/3P/4P 39968
	circuit breaker

	black toggle for: 42875
	rotary handle

part numbers C161N/H/L

Compact mccb's C161N/H/L with D type trip unit remote control units

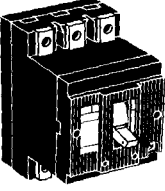
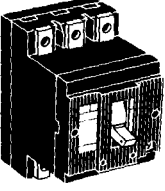
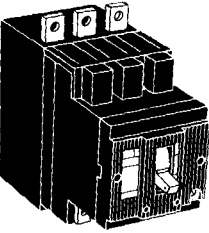
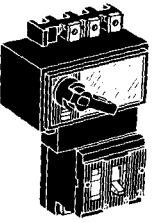
complete breaker...		rating					... consisting of:			
		2P 2t	3P 3t	4P 3t	4t	3t+N/2				
	fixed FC	80	40500	40504	40512	40508	40516	= C161N fixed FC + 1 set of rear connections per pole 41190		
		100	40501	40505	40513	40509	40517			
		125	40502	40506	40514	40510	40518			
		160	40503	40507	40515	40511	40519			
	fixed FC	80	40520	40524	40532	40528	40536		= C161N fixed FC + 1 set of plugs per pole 41194 + 1 plug-in-base FC/RC 2P 41195 3P 41196 4P 41197 + 1 set of short term, shield 2P/3P 42965 4P 42961	
		100	43521	40525	40533	40529	40537			
		125	40522	40526	40534	40530	40538			
		160	40523	40527	40535	40531	40539			
	plug-in FC RC	80	40540	40544	40552	40548	40556			= C161H fixed FC + 1 set of rear connections per pole 41190
		100	43541	40545	40553	40549	40557			
		125	40542	40546	40554	40550	40558			
		160	40543	40547	40555	40551	40559			
	fixed FC	80	40564	40562	40568	40566	= C161H fixed FC + 1 set of plugs per pole 41194 + 1 plug-in base FC/RC 3P 41196 4P 41197 + 1 set of short term. shields 3P 42965 4P 42961			
		100	40570	40563	40572	40575				
		125	40571	40574	40573	40576				
		160	40567	40565	40561	40569				
	fixed FC	80	40584	40592	40588	40596		= C161L fixed FC + 1 set of rear connections per pole 41190		
		100	40585	40593	40589	40597				
		125	40586	40594	40590	40598				
		160	40587	40595	40591	40599				
	plug-in FC RC	80	40604	40612	40608	40616			= C161N fixed FC + 1 set of rear connections per pole 41190	
		100	40605	40613	40609	40617				
		125	40606	40614	40610	40618				
		160	40607	40615	40611	40619				
	fixed FC	80	40624	40632	40628	40636	= C161N fixed FC + 1 set of rear connections per pole 41190			
		100	40625	40633	40629	40637				
		125	40626	40634	40630	40638				
		160	40627	40635	40631	40639				
	fixed FC	80	40644	40652	40648	40656		= C161N fixed FC + 1 set of rear connections per pole 41190		
		100	40645	40653	40649	40657				
		125	40646	40654	40650	40658				
		160	40647	40655	40651	40659				
	plug-in FC RC	80	40664	40672	40668	40676			= C161N fixed FC + 1 set of rear connections per pole 41190	
		100	40665	40673	40669	40677				
		125	40666	40674	40670	40678				
		160	40667	40675	40671	40679				
	fixed FC	80	■	■	■	■	= C161N fixed FC + 1 Visu module V160 3P 42413 4P 42414			
		to 160								
	fixed RC	80	■	■	■	■				= Visucompact C161N fixed FC + 2 sets of C161N RC (for line-side) 2x 42450 + 2 sets of C161N RC (for load-side) 2x 41190
		to 160								
			= Visucompact C161N fixed FC/RC + 1 Vigi module REH161 3P 41550 4P 41551 or Vigi module RMM161 3P 41612 4P 41613							
	auxiliaries and accessories specific to the Visucompact		auxiliary double-throw switch OF standard or CAM early break depending on mounting 42906							
		earthing switch for neutral in open position (compulsory if the transformer neutral is earthed on the load side of the Visucompact) 42415								
		locking of the Visu module in open position by 3 padlocks (not supplied) built-in 41940 by Ronis key lock 1351.500 (supplied) 42888 by Profalux key lock KS5 B24 D4Z (supplied) 42888								
		terminal shields for Visucompact or earth leakage Visucompact long terminal shields for FC (1 set) 3P 42969 4P 42963 short terminal shields for RC (1 set) 3P 42971 4P 42961								
		connectors line-side per pole 42460 load-side per pole 41183								
Compact NI type (load break switches)						page 112				
automatic and manual source changeover Compact						page 99				

**Vigicompact mccb's
C161N/H/L
Compact mccb's C161N/H/L
with Vigi module REH or RMM**



		complete breaker...					... consisting of:		
		rating	2P 2t	3P 3t	4P 3t	4t	3t+N/2		
Vigicompact C161N REH*	fixed FC	80		40854	40862	40858	40866	= C161N fixed FC + 1 Vigi module REH161	
		100		40855	40863	40859	40867		3P 41550 4P 41551
		125		40856	40864	40860	40868		
		160		40857	40865	40861	40869		
	fixed RC	80 to 160		■	■	■	■	= C161N REH fixed FC + 1 set of rear connections	
									per pole 41190
plug-in FC/RC	80 to 160		■	■	■	■	= C161N REH fixed FC + 1 set of Vigi plugs + 1 plug-in base FC/RC + 1 set of short term. shields		
								per pole 41199 3P 41196 4P 41197 3P 42965 4P 42961	
Vigicompact C161H REH*	fixed FC	80 to 160		■	■	■	= C161H fixed FC + 1 Vigi module REH61	3P 41550 4P 41551	
	fixed RC	80 to 160		■	■	■	= C161H fixed FC + 1 set of rear connections	per pole 41190	
	plug-in FC/RC	80 to 160		■	■	■	= C161H REH fixed FC + 1 set of Vigi plugs + 1 plug-in base FC/RC + 1 set of short term. shields	per pole 41199 3P 41196 4P 41197 3P 42965 4P 42961	
Vigicompact C161L REH*	fixed FC	80		40874	40882	40878	40886	= C161N fixed FC + 1 Vigi module REH161	
		100		40875	40883	40879	40887		3P 41550 4P 41551
		125		40876	40884	40880	40888		
		160		40877	40885	40881	40889		
	plug-in FC/RC	80 to 160		■	■	■	■	= C161N fixed FC + 1 Vigi module REH161	
Vigicompact C161N/H/L RMM*	fixed FC	80 to 160		■	■	■	= C161N/H/L same versions as for Vigi compact REH + 1 Vigi module RMM161	3P 41612 4P 41613	
	fixed RC(1)	80 to 160		■	■	■	= C161N/H/L same versions as for Vigi compact REH + 1 Vigi module RMM161	3P 41612 4P 41613	
	plug-in FC/RC(1)	80 to 160		■	■	■	= C161N/H/L same versions as for Vigi compact REH + 1 Vigi module RMM161	3P 41612 4P 41613	

Compact C161N/H/L with a Vigiex RCD and a separate toroid

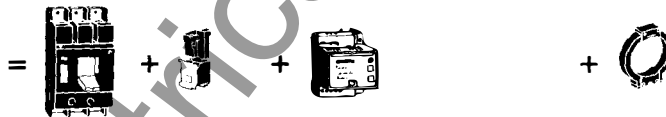

Compact fixed or plug-in (see page before)	voltage release (see page auxiliaries)	Vigiex RCD	toroidal sensor	shielded wire (2 conductors)
		RH50 220/240 V 50040	TNØ30 plug-in 50105	1=100 m 50136
		220/240 V 50041	PNØ50 50106	
		inherent safety model		
		RH53A 220/240 V 50082		
		380/415 V 50084		

		complete unit...				... consisting of:	
		voltage (V)	AC 50 Hz	AC 60 Hz	DC	= 1 adaptation plate + 1 motor unit	
remote control unit T161		24/30			39858		40623
		48/60					39800
		110/127	40580	40600	40620		39801
		220/240	40581	40601			39802
		250			40621		
		380/415	40582				39803
		440	40583				
							39808
							39809
							39808

		complete unit...				... consisting of:	
		voltage (V)	AC 50 Hz	AC 60 Hz	DC	Important:	
remote control unit TS161		110/127	40721	40721	40723	■ suitable only for Compact C161 4-pole, type N or H.	
		220/240	40722	40722		■ for C161N/H fixed RC, add:	
						+ 1 set of rear connection (per pole) 41190	
						+ 1 set of short 4P terminal shields 42961	
						■ for C161N/H plug-in FC/RC, add:	
						+ 4 set of Vigi plugs 4 x 41199	
						+ 1 set of short 4P terminal shields 42961	
						+ 1 plug-in base FC/RC 4P 41197	

Accessories for T101/T161 (remote control unit)		complete unit...		... consisting of:	
	plug-in wiring and auxiliaries		39818	IBN low level input converter	
	keylocking device		39820	OF version (continuous signal)	
	accessories for sealing in automatic position		39822	24 V DC 39824	
	sealable cover (TS161)		42974	48 V DC 39825	
				220/240 V AC 39826	

part numbers
C161N/H/L (continued)

Compact mccb's C161N/H/L
G and MA type

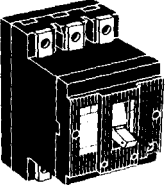
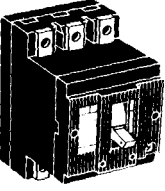
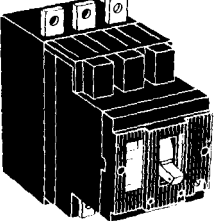
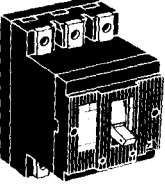
complete switch...		rating	3P 3t	4P 3t	4P 4t	... consisting of:			
	fixed FC	G80	40744		40748	= C161N type G fixed FC + connection accessories as for C161N (see p. 74)			
		G100	40745		40749				
		G125	40746		40750				
		G160	40747		40751				
	fixed RC	G80 to G160		■			■		
		plug-in FC RC	G80 to G160		■			■	
		fixed FC	SA63	40712			40713	= C161H type SA fixed FC + connection accessories as for C161H (see p. 74)	
			SA80	40704			40708		
			SA100	40705			40709		
			SA125	40706			40710		
SA160			40707		40711				
fixed RC		SA63 to SA160		■		■			
		plug-in FC RC	SA63 to SA160		■		■		
		fixed FC	SA63	40714		40715			
			SA80	40724		40728			
			SA100	40725		40729			
	SA125		40726		40730				
	SA160		40727		40731				
	fixed RC	SA63	40736		40737				
		SA80	40955		40959				
		SA100	40956		40960				
		SA125	40957		40961				
		SA160	40958		40962				
	plug-in FC RC	SA63	40738		40739				
		SA80	40967		40971				
		SA100	40968		40972				
		SA125	40969		40973				
		SA160	40970		40974				
	fixed FC	MA100	40765		40773	= C161H type MA fixed FC + connection accessories as for C161H (see p. 74)			
		MA125	40766		40774				
		MA160	40767		40775				
	fixed RC	MA100	40785		40793				
		MA125	40786		40794				
		MA160	40787		40795				
	plug-in FC RC	MA100 to MA160		■			■		
		Compact C161L type MA	fixed FC	MA100	40805			40813	
				MA125	40806			40814	
				MA160	40807			40815	
fixed RC	MA100		40835		40843				
	MA125		40836		40844				
	MA160		40837		40845				
plug-in FC RC	MA100	40935		40939					
	MA125	40936		40940					
	MA160	40937		40941					

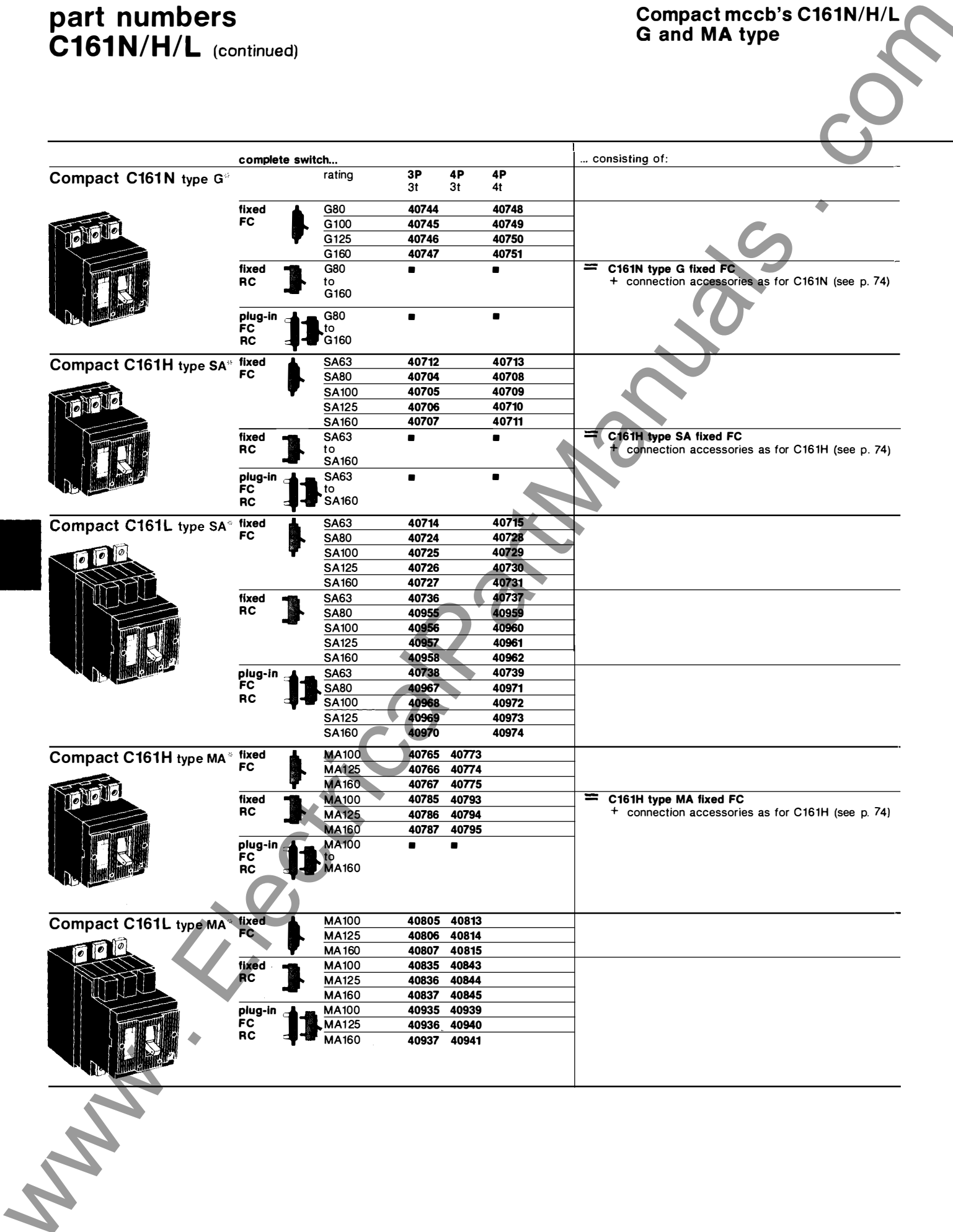

**Compact mccb's
C161N/H/L:
auxiliaries, accessories,
connection, spare parts**

electrical auxiliaries

auxiliary double-throw switches

	2 OF	42901
	1 OF + 1 SD	42902
	1 CAM (for rotary handle or Visu module)	42905

voltage release (for remote tripping)

	MX (shunt trip) AC 50/60 Hz or DC (V)	
	24	42910
	48/60	42911
	110/130	42912
	220/300	42913
	380/480	42914

MN (undervoltage release)

	AC 50 Hz (V)	DC (V)
	48	24
	110/130	48
	220/240	110/130
	380/415	250
	525	42927

AC 60 Hz

	(V)
	110/127
	220/240
	440

MN (with time delay relay)

	220 V 50/60 Hz = MN 110/130 V + time delay relay 250/700 ms
	42925
	42930

auxiliary wire-block (see quantity p. 56)

moving part

	short wires	3 term.	42942
	for types N/H	6 term.	42943
	long wires	3 term.	42944
	for type L	6 term.	42945

fixed part

	for all types	3 term.	42940
		6 term.	42941
	pack of 24 female clips		42946

accessories

chassis for plug-in CB

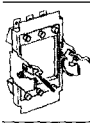
	for C161N/H	3P	41920
	for C161N/H	4P	41921
	for C161L	3P	41922
	for C161L	4P	41923
	horizontal chassis:	consult us	

auxiliaries specific to the chassis

auxiliary switches:			
	indicator for draw-out position		39965
	indicator for draw-in position		39966
locking in draw-out position with 1 key lock (supplied) Ronis 1351.500			
	Profalux KS5 B24 D4Z		41930
locking in draw-in and draw-out position with 1 key lock (supplied) Ronis 1351.500			
	Profalux KS5 B24 GAZ		41948
watertight escutcheon for operation through the door:			
	manual		41926
	remote control		40956
disconnectable auxiliary wire-block for "test position" (10 plugs per blocks), instead of standard auxiliary wire-block			
	additional auxiliary wire-block		41928

direct rotary handle

	with black toggle	41310
	red toggle	42891
	watertight escutcheon	42892
	MCC type	41316

extended rotary handle

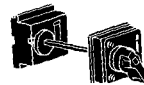
with door locking		
front door mounting		
	short shaft	41312 (= 41310 + 42882)
	long shaft	41311 (= 41310 + 42884)
rear door mounting		
	short shaft	41319 (= 41310 + 42889)
	long shaft	41320 (= 41310 + 42897)

without door locking

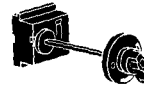
front door mounting		
	short shaft	41322 (= 41310 + 45853)

accessories for converting direct rotary handle to extended handle

with door locking		
front door mounting		
	short shaft	42882
	long shaft	42884
rear door mounting		
	short shaft	42889
	long shaft	42897
without door locking		
	short shaft	45853

shaft bracket

	for short shaft (always included on rotary handles with long shaft)	42868
---	--	-------

locking by padlocks or key lock

of the rotary handle (circuit breaker in OFF position)		
	by 3 padlocks (not supplied)	built-in
	1 Ronis key lock 1351.500	41940
	1 Profalux key lock KS5 B24 D4Z	42888

of the toggle (in OFF position)

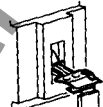
	by 3 padlocks (not supplied)	44936
---	------------------------------	-------

mechanical interlocking (for breakers with rotary handle)

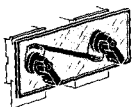
	mechanical device	44826
---	-------------------	-------

key locks interlocking (for breakers with rotary handle)

	1 set of 2 Ronis 1351.500 key locks (1 single key)	41950
	1 set of 2 Profalux KS5 B24 D4Z key locks (1 single key)	42878

sealing accessories

	for release, adjustment, cover	32970
---	--------------------------------	-------

circuit label holder

	pack of 10	42976
---	------------	-------

cut-out grommet

	for door for T101/T161	42977 39865
---	------------------------	----------------

tight bellows

	for toggle (IP43)	39969
---	-------------------	-------

locator

	for plug-in Compact C161L	42463
---	---------------------------	-------

sealable terminal shields

	short term. shields	2P/3P 42965 4P 42961
	long term. shields	2P/3P 42962 4P 42963
	extension for L type	3P 42966 4P 42967
	protective shield for plug-in base	2P/3P/4P 42968
	phase separators	2P/3P 42964

accessories for substitution

	mounting a C161N/H on a C160 base	2P/3P 40953 4P 40954
--	-----------------------------------	-------------------------

connections (see p. 61)

polybloc terminal (for bare cables)

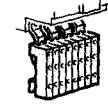
	6 cables $S \leq 10^2$	07100
---	------------------------	-------



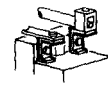

connectors for bare cables

	$2.5^2 \leq S \leq 16^2$	per pole 41185
	$16^2 \leq S \leq 95^2$ (Al)	per pole 40950
	$16^2 \leq S \leq 95^2$	per pole 41183

angle terminals (prohibited on C161H)

	for fixed FC version (long terminal shields compulsory)	per pole 41187
---	---	----------------

spare parts

	cover	2P/3P 41350 4P 41351
	neutral pole cap for 4-pole equipment with rotary handle	41313
	toggle	41352
	black toggle for: rotary handle Visu module V160	42875 42885

part numbers C250N/H/L

Compact mccb's C250N/H/L with type D trip unit



Compact C250N

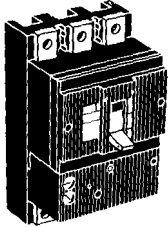

		Complete breaker...					
		rating	2P 2t	3P 3t	4P 3t	4t 3t + N/2	
fixed FC		D125		■	■	■	
		D160	⊕	43010	43014	43018	43022 43026
		D200		43011	43015	43019	43023 43027
		D250		43012	43016	43020	43024 43028
fixed RC		D125		■	■	■	
		D160	⊕	43034	43038	43042	43046 43050
		D200		43035	43039	43043	43047 43051
		D250		43036	43040	43044	43048 43052
plug-in FC RC		D125		■	■	■	
		D160	⊕	43082	43086	43090	43094 43098
		D200		43083	43087	43091	43095 43099
		D250		43084	43088	43092	43096 43100

.. consisting of:	
= C250N without release	2P 43001 3P 43002 4P 43003
+ 1 type D release	(see below)
= C250N fixed FC	per pole 43800
+ 1 set of rear connections	
= C250N fixed FC	per pole 43802
+ 1 set of plugs	
+ 1 plug-in base FC/RC	2P 43809 3P 43810 4P 43811
+ 1 set of short term. shields	2P/3P 43829 4P 43830

Compact C250H

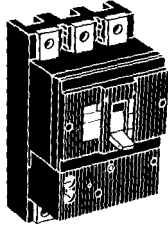

		rating	3P 3t	4P 3t	4t	3t + N/2
fixed FC		D125		■	■	■
		D160	⊕	43111	43115	43119 43123
		D200		43112	43116	43120 43124
		D250		43113	43117	43121 43125
fixed RC		D125		■	■	■
		D160	⊕	43131	43135	43139 43143
		D200		43132	43136	43140 43144
		D250		43133	43137	43141 43145
plug-in FC RC		D125		■	■	■
		D160	⊕	43171	43175	43179 43183
		D200		43172	43176	43180 43184
		D250		43173	43177	43181 43185

= C250H without release	3P 43104 4P 43105
+ type D release	(see below)
= C250H fixed FC	per pole 43800
+ 1 set of rear connections	
= C250H fixed FC	per pole 43802
+ 1 set of plugs	
+ 1 plug-in base FC/RC	3P 43810 4P 43811
+ 1 set of short term. shields	3P 43829 4P 43830

Compact C250L

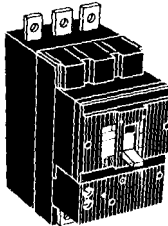

		rating	3P 3t	4P 3t	4t	3t + N/2
fixed FC		D125		■	■	■
		D160	⊕	43195	43199	43203 43207
		D200		43196	43200	43204 43208
		D250		43197	43201	43205 43209
fixed RC		D125		■	■	■
		D160	⊕	43219	43223	43227 43231
		D200		43220	43224	43228 43232
		D250		43221	43225	43229 43233
plug-in FC RC		D125		■	■	■
		D160	⊕	43243	43247	43251 43255
		D200		43244	43248	43252 43256
		D250		43245	43249	43253 43257

= C250L without release, fixed FC	3P 43188 4P 43189
+ type D release	(see below)
= C250L without release, fixed RC	3P 43212 4P 43213
+ type D release	(see below)
= C250L without release, plug-in without base	3P 43236 4P 43237
+ type D release	(see below)
+ 1 plug-in base FC/RC	3P 43810 4P 43811

trip units

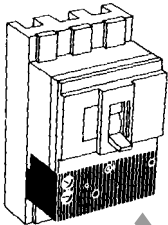

Standard type D release					
rating	2P 2t	3P 3t	4P 3t	4t	3t + N/2
D125	⊕	43259	43275	43276	
D160	⊕	43260	43263	43266	43269 43272
D200		43261	43264	43267	43270 43273
D250		43262	43265	43268	43271 43274

Selective type SA release for C250L only		
rating	3P 3t	4P 4t
SA125	43284	43289
SA160	43285	43290
SA200	43286	43291
SA250	43287	43292

Type MA release		
rating	3P 3t	4P 4t
MA250	43308	43311

Low magnetic setting type G release		
rating	3P 3t	4P 4t
G200	43277	43280
G250	43278	43281

Selective type SB release for C250L only		
rating	3P 3t	4P 4t
SB125	⊕	43296 43300
SB160		43297 43301
SB200		43298 43302
SB250		43299 43303

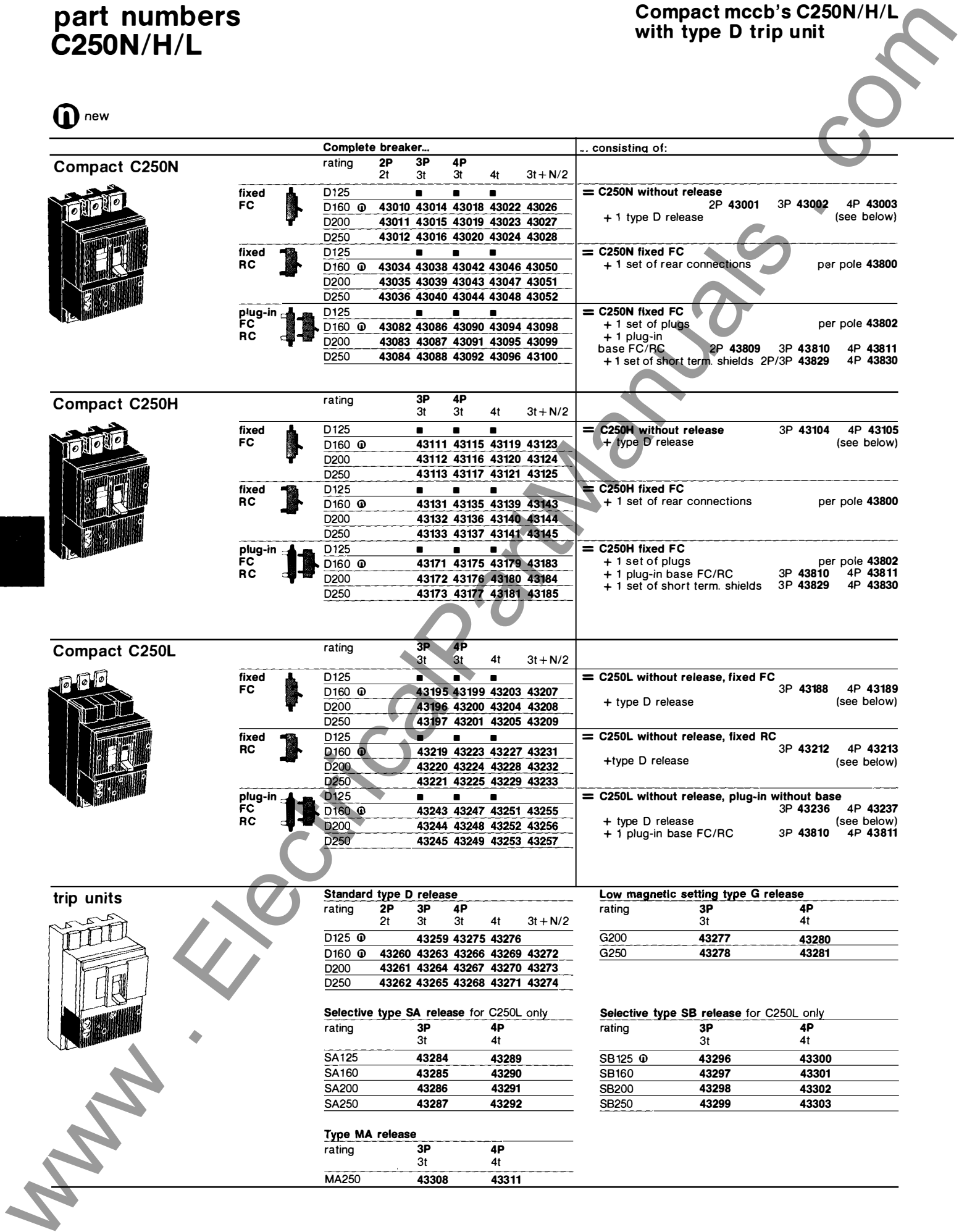

**Vigicompact mccb's
C250N/H/L
Compact mccb's C250N/H/L:
with Vigi module REH or REB**

		complete breaker...				... consisting of:		
		rating	3P 3t	4P 3t	4t	3t N/2		
	fixed FC	D125	■	■	■			
		D160	43347	43350	43353	43356		
		D200	43348	43351	43354	43357		
		D250	43349	43352	43355	43358		
	fixed RC	D125 to D250	■	■	■	■ ⁽¹⁾		
		= C250N fixed FC + 1 Vigi module REH250 3P 43340 4P 43341						
	plug-in FC RC	D125 to D250	■	■	■	■ ⁽¹⁾		
		= C250N REH fixed FC + 1 set of Vigi plugs per pole 43803 + 1 plug-in base FC/RC 3P 43810 4P 43811 + 1 set of short term. shields 3P 43829 4P 43830						
	<hr/>							
	Vigicompact C250H REH*	fixed FC	D125 to D250	■	■	■	■ ⁽¹⁾	
= C250H fixed FC + 1 Vigi module REH250 3P 43340 4P 43341								
fixed RC			D125 to D250	■	■	■	■ ⁽¹⁾	
			= C250H REH fixed FC + 1 set of rear connections per pole 43800					
plug-in FC RC		D125 to D250	■	■	■	■ ⁽¹⁾		
		= C250H REH fixed FC + 1 set of Vigi plugs per pole 43803 + 1 plug-in base FC/RC 3P 43810 4P 43811 + 1 set of short term. shields 3P 43829 4P 43830						
<hr/>								
Vigicompact C250L REH*		fixed FC	D125	■	■	■		
			D160	43425	43428	43431	43434	
			D200	43426	43429	43432	43435	
	D250		43427	43430	43433	43436		
	plug-in FC RC	D125 to D250	■	■	■	■ ⁽¹⁾		
		= C250L fixed FC + 1 Vigi module REH250 3P 43340 4P 43341						
	= C250L without release, plug-in without base, with Vigi connections 3P 43348 4P 43349 + type D release (see opposite page) + 1 Vigi module REH250 3P 43340 4P 43341 + 1 plug-in base FC/RC 3P 43810 3P 43811 + 1 set of short term. shields 3P 43829 4P 43830							

**Compact C250N/H/L
with a Vigiex RCD
and a separate
toroid**

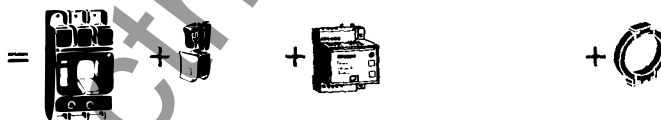

Compact fixed or plug-in (see page before)	voltage release (see page electrical auxiliaries)	Vigiex RCD	toroidal sensor	shielded wire (2 conductors) l = 100 m
		RH50 220/240 V 50040	TNØ30 plug-in 50105	
		220/240 V 50041	PNØ50 50106	
		inherent safety model		
		RH53A 220/240 V 50082		
		380/415 V 50084		

part numbers C250N/H/L (continued)

Visucompact mccb's C250N Compact mccb's C250N: remote control

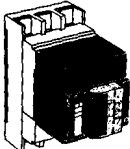

		complete breaker...				... consisting of:	
		rating	3P 3t	4P 3t	4t	3t + N/2	
Visucompact C250N* 	fixed FC	D125 ⁽¹⁾ to D250	■	■	■	■	C250N fixed FC + 1 Visu module V250 3P 43329 4P 43330
	fixed RC	D125 ⁽¹⁾ to D250	■	■	■	■	Visucompact C250N fixed FC + 1 set of rear connections per pole 43800
earth leakage Visucompact C250N REH*	fixed FC	D125 ⁽¹⁾ to D250	■	■	■	■	Visucompact C250N fixed FC/RC + 1 Vigi module REH250 3P 43340 4P 43341
	fixed RC	D125 ⁽¹⁾ to D250	■	■	■	■	
auxiliaries and accessories specific to the Visucompact		auxiliary double-throw switch		OF standard or CAM early break depending on mounting		42906	
		earthing switch for neutral in open position (compulsory if the transformer neutral is earthed on the load side of the Visucompact)				43332	
		locking of the Visu module in open position		by 3 padlock (not supplied)		built-in	
				by Ronis key lock 1351-500 (supplied)		41940	
				by Profalux key lock KS5 B24 D4Z (supplied)		42888	
		terminal shields for Visucompact or earth leakage Visucompact		long terminal shields for FC (1 set)		3P 43838 4P 43832	
				short terminal shields for RC (1 set)		3P 43839 4P 43830	
		connection		same as fixed Compact		(p. 81)	
Compact NI type (load break switches)						page 112	
automatic and manual source changeover Compact						page 101	
adaptable motor mechanism T250 	AC 50/60 Hz (V)				DC (V)		
	110/127 ⁽¹⁾		43775		24 ⁽¹⁾		43770
	220/240 ⁽¹⁾		43776		48/60 ⁽¹⁾		43771
	380/415 ⁽²⁾		43777		110/125 ⁽¹⁾		43772
	440/480 ⁽²⁾		43778		220/250 ⁽¹⁾		32773
adaptable motor mechanism TS250	AC 50/60 Hz (V)				DC (V)		
	110/127 ⁽¹⁾		43754		110/125 ⁽¹⁾		43752
	220/240 ⁽¹⁾		43755				
accessories for motor mechanism		SDE alarm switch				44906	
		Sealable cover				42974	
		locking of the motor mech. ⁽¹⁾ by 1 key lock (not supplied)				44876	
		Ronis 1351.500 or Profalux KS5 B24 D4Z					

(1) Direct supply motor mechanism.
(2) Motor mechanism supplied through an additional resistor.

■ T400/630 380/415 V 43877
 ■ T400/630 220/240 V 43776 + resistor 44870
 ■ T400/630 440/480 V 43878

electrical auxiliaries

auxiliary double-throw switches

	2 OF	42901
	1 OF+1 SD	42902
	1 CAM (for rotary handle or Visu module)	42905

voltage release (for remote tripping)

	MX (shunt trip) AC 50/60 Hz or DC (V)	
	24	42910
	48/60	42911
	110/130	42912
	220/300	42913
	380/480	42914

	MN (undervoltage release) AC 50 Hz	DC	
	(V)	(V)	
	48	24	42923
	110/130	30	42938
	220/240	48	42924
	380/415	110/130	42925
	525	250	42926

	AC 60 Hz (V)	
	110/127	42931
	220/240	42928
	440	42933

	MN (with time delay relay) 220 V AC 50/60 Hz	
	= MN 110/130 V DC	42925
	+ time delay relay 250/700 ms	42930

auxiliary wire block (see quantity p. 55)

	moving part	
	short wires	3 term. 42942
	for types N/H	6 term. 42943
	long wires	3 term. 42944
	for type L	6 term. 42945

	fixed part	
	for all types	3 term. 42940
		6 term. 42941
	pack of 24 female clips	42946

accessories

chassis for plug-in CB

	for Compact without motor mechanism	
	C250N/H	3P 43786
	C250N/H	4P 43787
	C250L	3P 43788
	C250L	4P 43789

for Compact with motor mechanism

	C250N/H	3P 43790
	C250N/H	4P 43791
	C250L	3P 43792
	C250L	4P 43793
	horizontal chassis:	consult us

auxiliaries specific to the chassis

	locking in draw-out position with 1 key lock (supplied) Ronis 1351.500	41929
	Profalux KS5 B24 D4Z	41930
	locking in draw-in position with 1 key lock (supplied) Ronis 1351.500	41947
	Profalux KS5 B24 GAZ	41948
	watertight escutcheon for manual operation through the door	41926
	disconnectable auxiliary wire block for "test position" (10 plugs per blocks), instead of standard auxiliary wire-block	43795
	additional auxiliary wire-block (10 plugs per block)	41928

direct rotary handle

	with black toggle	43820
	red toggle	42891
	watertight escutcheon	44940



	MCC type	43824
---	----------	-------

extended rotary handle

	with door locking	
	front door mounting	
	short shaft	43821
	(= 43820 + 42882)	
	long shaft	43835
	(= 43820 + 42884)	
	rear door mounting	
	short shaft	43846
	(= 43820 + 42889)	
	long shaft	43847
	(= 43820 + 42897)	

	without door locking	
	front door mounting	
	short shaft	43822
	(= 43820 + 45853)	

accessories for converting direct rotary handle to extended handle

	with door locking	
	front door mounting	
	short shaft	42882
	long shaft	42884
	rear door mounting	
	short shaft	42889
	long shaft	42897
	without door locking	
	short shaft	45853

shaft bracket

	for short shaft (always included on rotary handles with long shaft)	42868
---	--	-------

locking by padlocks or key lock

	of the rotary handle (circuit-breaker in OFF position) by 3 padlocks (not supplied) built-in	
	1 Ronis key lock 1351.500	41940
	1 Profalux key lock KS5 B24 D4Z	42888

	of the toggle (in OFF position) by 3 padlocks (not supplied)	44936
---	---	-------

mechanical interlocking

	(for breakers with rotary handle) mechanical device	44826
---	--	-------

key locks interlocking

	(for breakers with rotary handle)	
	1 set of 2 Ronis 1351.500 key locks (1 single key)	41950
	1 set of 2 Profalux KS5 B24 D4Z key locks (1 single key)	42878

sealing accessories

	for release, adjustment, cover	39970
---	-----------------------------------	-------

	circuit label holder pack of 10	42976
---	---	-------

	cut-out grommet for door Compact fixed or plug-in with motor mechanism	42977 43745
---	---	----------------

	tight bellows for toggle (IP43)	42896
---	---	-------

	locator for plug-in contact	43816
---	---------------------------------------	-------

	sealable terminal shields	
	short term. shields	2P/3P 43829 4P 43830
	long term. shields	2P/3P 43831 4P 43832
	extension for L type	3P 43833 4P 43834
	protective shield for plug-in base	2P/3P/4P 43836
	phase separators	2P/3P 43840

connection (see p. 61)

	connectors for bare cables	
	16° ≤ S ≤ 185° (Alu)	per pole 43813
	16° ≤ S ≤ 185°	per pole 43828

angle terminals

	for fixed FC (long terminal shields compulsory)	per pole 43815
---	---	----------------

spare parts

	cover	2P/3P 43940 4P 43941
---	-------	-------------------------





	neutral pole cap for 4-pole equipment with rotary handle	43947
---	--	-------



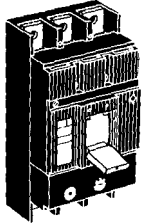

	toggle	43945
---	--------	-------



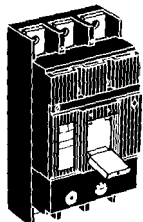

	block toggle for: rotary handle Visu module V250	42875 44846
---	--	----------------

part numbers C401N/H/L

Compact mccb's C401N/H/L with D type trip unit

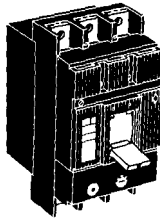
		complete breaker...				consisting of:						
		rating	2P 2t	3P 3t	4P 3t	4t	3t + N/2						
Compact C401N		fixed FC		D321	44663	44665	44667	44669	44671	= C401N without release + type D release	2P 44660	3P 44661	4P 44662
				D401	44664	44666	44668	44670	44672		(here under)		
		fixed RC		D321	44693	44695	44697	44699	44701	= C401N fixed FC + 1 set of rear connections	per pole 44800		
				D401	44694	44696	44698	44700	44702				
		plug-in FC RC		D321	44719	44721	44723	44725	44727	= C401N fixed FC + 1 set of plugs (1) + 1 plug-in base FC/RC	per pole 44802		
				D401	44720	44722	44724	44726	44728		+ 1 set of short term. shields	2P 44809	3P 44810
											2P/3P 44829	4P 44830	

		complete breaker...				consisting of:					
		rating	3P 3t	4P 3t	4t	3t + N/2						
Compact C401H		fixed FC		D321	44675	44677	44679	44681	= C401H without release + type D release	3P 44673	4P 44674	
				D401	44676	44678	44680	44682		(here under)		
		fixed RC		D321	44703	44705	44707	44709	= C401H fixed FC + 1 set of rear connections	per pole 44800		
				D401	44704	44706	44708	44710				
		plug-in FC RC		D321	44729	44731	44733	44735	= C401H fixed FC + 1 set of plugs (1) + 1 plug-in base FC/RC	per pole 44802		
				D401	44730	44732	44734	44736		+ 1 set of short term. shields	3P 44810	4P 44811
											3P 44829	4P 44830

		complete breaker...				consisting of:					
		rating	3P 3t	4P 3t	4t	3t + N/2						
Compact C401L		fixed FC		D321	44685	44687	44689	44691	= C401L without release, with spacing supports + type D release	3P 44683	4P 44684	
				D401	44686	44688	44690	44692		(here under)		
		fixed RC		D321	44711	44713	44715	44717	= C401L fixed FC, with spacing supports + 1 set of connections + 1 set of connections for supports	per pole 44839	per pole 44800	
				D401	44712	44714	44716	44718				
		plug-in FC RC		D321	44737	44739	44741	44743	= C401L fixed FC with spacing supports + 1 set of connections for supports + 1 set of plugs(1) + 1 plug-in base FC/RC	per pole 44839	per pole 44802	
				D401	44738	44740	44742	44744		+ 1 set of short term. shields	3P 44810	4P 44811
											3P 44829	4P 44830

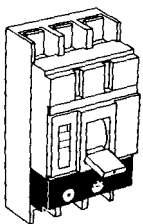



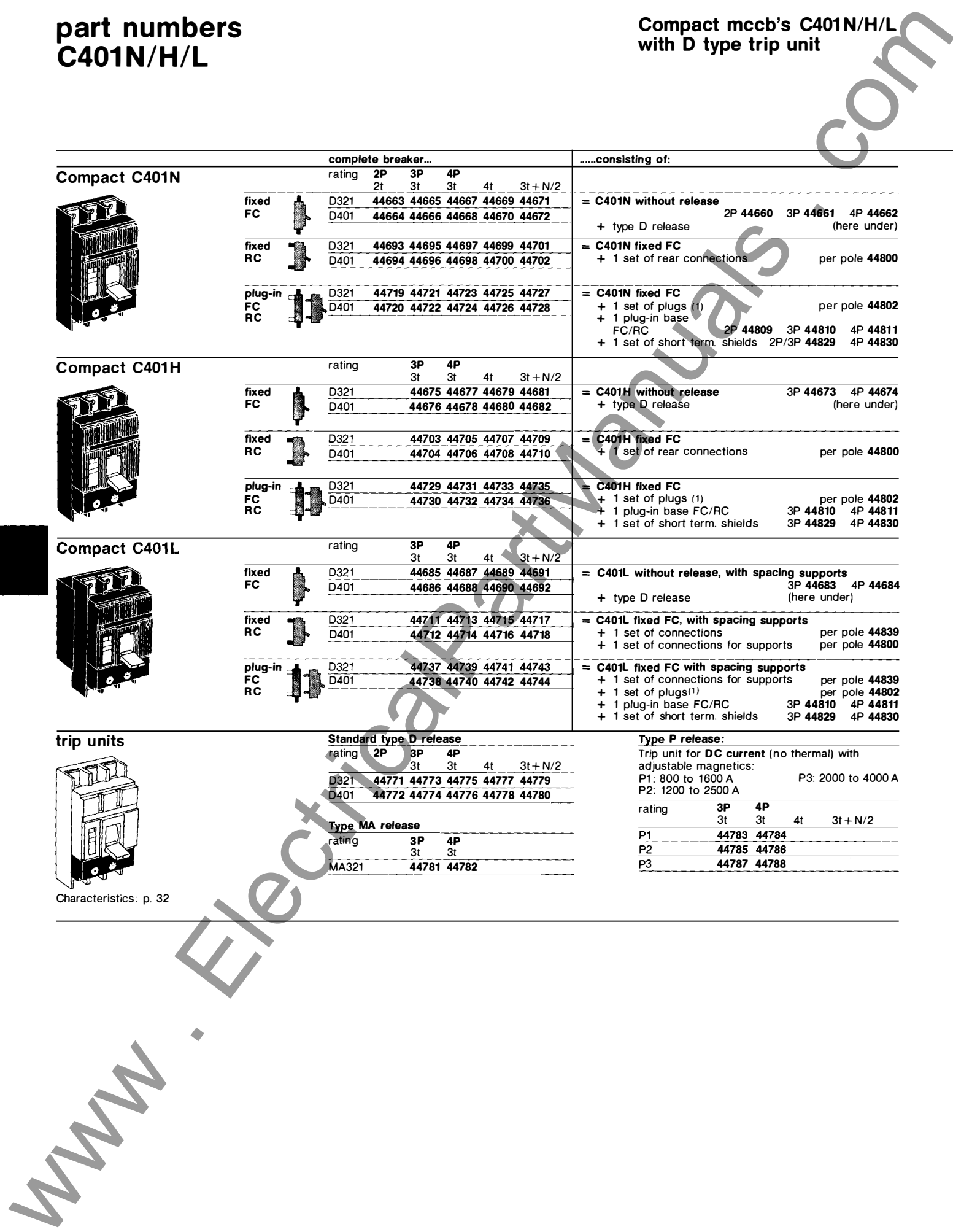



trip units		Standard type D release					Type P release:	
		rating	2P 3t	3P 3t	4P 3t	4t	3t + N/2	
		D321	44771	44773	44775	44777	44779	Trip unit for DC current (no thermal) with adjustable magnetics: P1: 800 to 1600 A P3: 2000 to 4000 A P2: 1200 to 2500 A
		D401	44772	44774	44776	44778	44780	
		Type MA release					rating	
		rating	3P 3t	4P 3t			3P	4P
		MA321	44781	44782			44783	44784
						P2	44785	44786
						P3	44787	44788

Characteristics: p. 32



**Vigilcompact mccb's
C401N/H/L
Compact mccb's C401N/H/L
with Vigirex RCD**



		complete breaker...				... consisting of:	
		rating	3P 3t	4P 3t	4t	3t + N/2	
Vigilcompact C401N REM*	fixed FC 	D321	44745	44747	44749	44751	= C401N fixed FC + 1 Vigi module REM401/400/630 3P 44430 4P 44431
		D401	44746	44748	44750	44752	
	fixed RC 	D321 to D401	■	■	■	■	= C401N REM fixed FC + 1 set of rear connections per pole 44800
plug-in FC RC 	D321 to D401	■	■	■	■	= C401N REM fixed FC + 1 set of plugs ⁽¹⁾ per pole 44802 + 1 plug-in base FC/RC 3P 44817 4P 44818 + 1 set of short term. shields 3P 43829 4P 43830	
Vigilcompact C401H REM*	fixed FC 	D321	44753	44756	44759	44761	= C401H fixed FC + 1 Vigi module REM401/400/630 3P 44430 4P 44431
		D401	44754	44757	44760	44762	
	fixed RC 	D321 to D401	■	■	■	■	= C401N REM fixed FC + 1 set of rear connections per pole 44800
plug-in FC RC 	D321 to D401	■	■	■	■	= C401H REM fixed FC + 1 set of plugs ⁽¹⁾ per pole 44802 + 1 plug-in base FC/RC 3P 44817 4P 44818 + 1 set of short term. shields 3P 44829 4P 44830	
Vigilcompact C401L REM*	fixed FC 	D321	44763	44765	44767	44769	= C401L fixed FC with spacing supports + 1 Vigi module REM401/400/630 3P 44430 4P 44431
		D401	44764	44766	44768	44770	
	fixed RC 	D321 to D401	■	■	■	■	= C401L REM fixed FC with spacing supports + 1 set of connections for supports per pole 44839 + 1 set of rear connections per pole 44800
plug-in FC RC 	D321 to D401	■	■	■	■	= C401L REM fixed FC with spacing supports + 1 set of connections for supports per pole 44839 + 1 set of plugs ⁽¹⁾ per pole 44802 + 1 plug-in base FC/RC 3P 44817 4P 44818 + 1 set of short term. shields 3P 44829 4P 44830	

**Compact C401N/H/L
with a Vigirex RCD
and a separate
toroid**

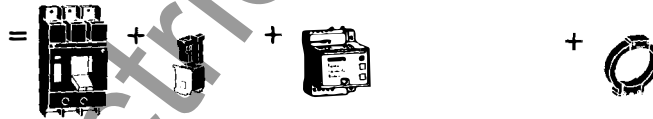

**Compact
fixed or
plug-in
(see page
before)**

**voltage
release**
(see page
electrical
auxiliaries)

Vigirex RCD		
RH50	220/240 V	50040
	220/240 V	50041
	inherent safety model	
RH53A	220/240 V	50082
	380/415 V	50084

toroidal sensor	
INØ80	50107
MNØ120	50108

shielded wire (2 conductors)	
l = 100 m	50136

part numbers C400N/H/L ST

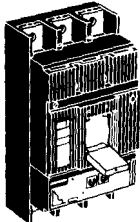
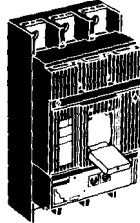
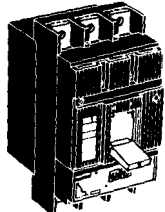

Compact mccb's C400N/H/L ST with ST control units

		complete breaker...	... consisting of:				
		rating	3P 3t	4P 3t	4t	3t+N/2	
	fixed FC	ST204S	44500	44501	44502	44503	
	fixed RC	ST204S	44506	44507	44508	44509	= C400N ST fixed FC + 1 set of rear connections per pole 44800
	plug-in FC RC	ST204S	44518	44519	44520	44521	= C400N ST fixed FC + 1 set of plugs ⁽¹⁾ per pole 44802 + 1 plug-in base FC/RC 3P 44810 4P 44811 + 1 set of short term. shields 3P 44829 4P 44830
		with built-in solid state release					
	fixed FC	ST204S	44530	44531	44532	44533	
	fixed RC	ST204S	44536	44537	44538	44539	= C400H ST fixed FC + 1 set of rear connections per pole 44800
	plug-in FC RC	ST204S	44548	44549	44550	44551	= C400H ST fixed FC + 1 set of plugs ⁽¹⁾ per pole 44802 + 1 plug-in base FC/RC 3P 44810 4P 44811 + 1 set of short term. shields 3P 44829 4P 44830
		with built-in solid state release					
	fixed FC	ST204S	44560	44561	44562	44563	
		ST204SB	44564	44288	44565	44289	
	fixed RC	ST204S	44566	44567	44568	44569	= C400L ST fixed with spacing supports + 1 set of connections for supports per pole 44839 + 1 set of rear connections per pole 44802
	ST204SB	44570	44290	44571	44291		
plug-in FC RC	ST204S	44572	44573	44574	44575	= C400L ST fixed FC with spacing supports + 1 set of connections for supports per pole 44839 + 1 set of plugs ⁽¹⁾ 3P 44802 + 1 plug-in base FC/RC 3P 44810 4P 44811 + 1 set of short term. shields 3P 44829 4P 44830	
	ST204SB	44576	44292	44577	44293		
		with built-in solid state release					

www.ElectricalPartManuals.com

**Vigicompact mccb's
C400N/H/L ST
Compact mccb's
C400N/H/L ST
with Vigirex RCD**

www.electricalpart.com

complete breaker...				... consisting of:			
	rating	3P 3t	4P 3t	4t	3t + N/2		
	fixed FC	ST204S	44317	44318	44319	44320	= C400N ST fixed FC + 1 Vigi module REM401/400/630 3P 44430 4P 44431
	fixed RC	ST204S	■	■	■	■	= C400N ST REM fixed FC + 1 set of rear connections per pole 44800
	plug-in FC RC	ST204S	■	■	■	■	= C400N ST REM fixed FC + 1 set of plugs (1) per pole 44802 + 1 plug-in base FC/RC 3P 44817 4P 44818 + 1 set of short term. shields 3P 44829 4P 44830
	rating	3P 3t	4P 3t	4t	3t + N/2		
	fixed FC	ST204S	44321	44322	44323	44324	= C400H ST fixed FC + 1 Vigi module REM401/400/630 3P 44430 4P 44431
	fixed RC	ST204S	■	■	■	■	= C400H ST REM fixed FC + 1 set of rear connections per pole 44800
	plug-in FC RC	ST204S	■	■	■	■	= C400N ST REM fixed FC + 1 set of plugs (1) per pole 44802 + 1 plug-in base FC/RC 3P 44817 4P 44818 + 1 set of short term. shields 3P 44829 4P 44830
	rating	3P	4P	4t	3t + N/2		
		3t	3t				
	fixed FC	ST204S	44325	44326	44327	44328	= C400L ST fixed FC with spacing supports + 1 Vigi module REM401/400/630 3P 44430 4P 44431
		ST204SB	■	■	■	■	
	fixed RC	ST204S	■	■	■	■	= C400L ST REM fixed FC with spacing supports + 1 set of connections for supports per pole 44839 + 1 set of rear connections per pole 44800
		ST204SB	■	■	■	■	
plug-in FC RC	ST204S	■	■	■	■	= C400L ST REM fixed FC with spacing supports + 1 set of connections for supports per pole 44839 + 1 set of plugs (1) per pole 44802 + 1 plug-in base FC/RC 3P 44817 4P 44818 + 1 set of short term. shields 3P 44829 4P 44830	
	ST204SB	■	■	■	■		

**Compact C400N/H/L ST
with a Vigirex RCD
and a separate
toroid**



Compact fixed or plug-in (see previous page)	voltage release (see page electrical auxiliaries)	Vigirex RCD	toroidal sensors	shielded wire (2 conductors)
		RH50 220/240 V 50040	IN Ø80 50107	l = 100 m 50136
		220/240 V 50041	MN Ø120 50108	
		inherent safety model		
		RH53A 220/240 V 50082		
		380/415 V 50084		

www.electricalpart.com

part numbers C401N/H/L and C400N/H/L ST

Visucompact mccb's
C401N/H/L and
C400N/H/L ST

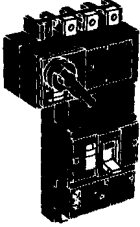
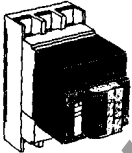
		complete breaker...				...consisting of:	
		rating	3P 3t	4P 3t	4t	3t+N/2	
	fixed FC	D321 to D401	■	■	■	■	= C401N fixed FC + 1 Visu module V400 3P 44410 4P 44411
	fixed RC	D321 to D401	■	■	■	■	= Visucompact C401N fixed FC + 1 set of rear connections per pole 44800
Visucompact C400N ST**	fixed FC	ST204S	■	■	■	■	= C400N ST fixed FC + 1 Visu module V400 3P 44410 4P 44411
	fixed FC	ST204S	■	■	■	■	= Visucompact C400N ST fixed FC + 1 set of rear connections per pole 44800
earth leakage Visucompact C401N REM*	fixed FC	D321 to D401	■	■	■	■	= Visucompact C401N fixed FC + 1 Vigi module REM401/400/630 3P 44430 4P 44431
	fixed RC	D321 to D401	■	■	■	■	
earth leakage Visucompact C400N ST REM*	fixed FC	ST204S	■	■	■	■	= Visucompact C400N ST fixed FC/RC + 1 Vigi module REM401/400/630 3P 44430 4P 44431
	fixed RC	ST204S	■	■	■	■	
auxiliaries and accessories specific to the Visucompact	auxiliary double-throw switch						OF standard or CAM early break depending on mounting 42906 2 OF 47757
	earthing switch for neutral in open position (compulsory if the transformer neutral is earthed on the load side of the Visucompact)						44413
	locking of the Visu module in open position						by 3 padlock (not supplied) built-in 41940 by Ronis key lock 1351.500 (supplied) 41940 by Profalux key lock KS5 B24 D4Z (supplied) 42888
	terminal shields for Visucompact or earth leakage Visucompact						long terminal shields for FC (1 set) 3P 44833 4P 44832 short terminal shields for RC (1 set) 3P 44834 4P 44830
	connection						same as fixed Compact C401N or C400N ST (p. 87)
Compact NI type (load break switches)							page 112
automatic and manual source changeover Compact							page 101
adaptable motor mechanism T401/400 	AC 50/60 Hz (V)						DC (V)
	110/127 ⁽¹⁾						24 ⁽¹⁾
	220/240 ⁽¹⁾						48/60 ⁽¹⁾
	380/415 ⁽²⁾						110/120 ⁽¹⁾
	440/480 ⁽²⁾						220/250 ⁽¹⁾
adaptable motor mechanism TS401/400	AC 50/60 Hz (V)						DC (V)
	110/127 ⁽¹⁾						110/125 ⁽¹⁾
	220/240 ⁽¹⁾						
accessories for motor mechanism	SDE alarm switch						44906
	sealable cover						42974
	locking of the motor mech. ⁽¹⁾ by 1 key lock (not supplied)						44876
	Ronis 1351.500 or Profalux KS5 B24 D4Z						

(1) Direct supply motor mechanism.

(2) Motor mechanism supplied through an additional

(3) Not used for ATS.

* Note: the marks ■ indicate that the breaker is

Compact mccb's C401N/H/L and C400N/H/L ST: auxiliaries, accessories, connections, spare parts

electrical auxiliaries

auxiliary double-throw switches

	1 OF + 1 SD	44900
	3 OF + 1 SD	44901
	1 CAM (for rotary handle or Visu module)	44827

voltage release (for remote tripping)

	MX (shunt trip) AC 50/60 Hz or DC (V)	
	24	44910
	48/60	44911
	110/130	44912
	220/300	44913
	380/480	44914

	MN (undervoltage release) AC 50 Hz DC (V) (V)	
	48 44919 24 44923	
	110/130 44925 30 44917	
	220/240 44926 48 44924	
	380/415 44932 110/130 44925	
		250 44926
		300 44932

AC 60 Hz (V)	
110/127	44925
220/240	44926
440	44649

MN (with time delay relay) 220 V AC 50/60 Hz = MN 110/130 V DC + time delay relay 250/700 ms	44925 + 44930
--	--------------------------------

auxiliary wire block (see quantity p. 55)

	moving part	
	short wires	3 term. 42942
	for types N/H	6 term. 42943
	long wires	3 term. 42944
	for type L	6 term. 42945
	fixed part	
	for all types	3 term. 42940
		6 term. 42941
	pack of 24 female clips	42946

accessories

chassis for plug-in CB

for Compact without motor mechanism

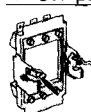
	401N/H or	3P	44892
	400N/H ST	4P	44893
	plug-in FC/RC		
	C401L or	3P	44894
	C400L ST	4P	44895
	plug-in FC/RC		

for Compact with motor mechanism

	C401N/H or	3P	44896
	C400N/H ST	4P	44897
	plug-in FC/RC		
	C401L or	3P	44898
	C400L ST	4P	44899
	plug-in FC/RC		
	horizontal chassis:		consult us

auxiliaries specific to the chassis

auxiliary switches:	
indicator for draw-out position	39965
indicator for draw-in position	39966
locking in draw-out position with 1 key lock (supplied) Ronis 1351.500	41929
Profalux KS5 B24 D4Z	41930
locking in draw-in and draw-out position with 1 key lock (supplied) Ronis 1351.500	41947
Profalux KS5 B24 GAZ	41948
watertight escutcheon for manual operation through the door	44904
disconnectable auxiliary wire block for "draw-out position" (10 pins per block),	



direct rotary handle	
with black toggle	44820
red toggle	44847
watertight escutcheon	44940

extended rotary handle

with door locking	
front door mounting	
	short shaft 44821 (= 44820 + 42882)
	long shaft 44835 (= 44820 + 42884)
rear door mounting	
	short shaft 44837 (= 44820 + 42889)
	long shaft 44840 (= 44820 + 42897)

without door locking

front door mounting	
	short shaft 44828 (= 44820 + 45853)

accessories for converting direct rotary handle to extended handle

with door locking	
front door mounting	
	short shaft 42882
	long shaft 42884
rear door mounting	
	short shaft 42889
	long shaft 42897

without door locking

short shaft	45853
-------------	--------------

shaft bracket

for short shaft (always included on rotary handles with long shaft)	42868
---	--------------

locking by padlocks or key lock

of the rotary handle (circuit-breaker in OFF position)	
by 3 padlocks (not supplied)	built-in
1 Ronis key lock 1351.500	41940
1 Profalux key lock KS5 B24 D4Z	42888

of the toggle (in OFF position)	
by 3 padlocks (not supplied)	44936

mechanical interlocking

(for breakers with rotary handle)	
mechanical device	44826

key locks interlocking

(for breakers with rotary handle)	
1 set of 2 Ronis 1351.500 key locks (1 single key)	41950
1 set of 2 Profalux KS5 B24 D4Z key locks (1 single key)	42878

sealing accessories

for release, adjustment, cover	44937
for ST release	44587

circuit label holder

pack of 10	42976
------------	--------------

cut-out grommet for door

Compact fixed or plug-in without motor mechanism	44938
with motor mechanism	43745

tight bellows

for toggle (IP43)	44965
-------------------	--------------

locator

for plug-in Compact	43816
---------------------	--------------

sealable terminal shields

short term. shields 2P/3P	44829
4P	44830
long term. shields 2P/3P	44831
4P	44832
protective shield 2P/3P/4P for plug-in base	44836

connection (see p. 61)

connectors for bare cables

single connector per pole for 1 cable $70^{\circ} \leq S \leq 300^{\circ}$	44813
double connector per pole for 2 cables $70^{\circ} \leq S \leq 240^{\circ}$	44814

angle terminals

for fixed FC version (long terminal shields compulsory)	per pole 44815
---	-----------------------

spreader

for fixed FC or plug-in FC/RC version	3P 44841
	4P 44842

spare parts

cover	2P/3P/4P 44960
-------	-----------------------

toggle extension	44964
------------------	--------------

black toggle for:

rotary handle	44846
Visu module V400/630	45858

**Vigicompact mccb's
C630N/H/L
Compact mccb's C630N/H/L
with Vigirex RCD**

		complete breaker...				consisting of:		
		rating	3P 3t	4P 3t	4t	3t + N/2		
	fixed FC	D321 @	■	■	■	■	= C630N fixed FC + 1 Vigi module REM401/400/630	
		D401 @	45400	45404	45408	■		3P 44430 4P 44431
		D500	45401	45405	45409	45413		
		D630	45402	45406	45410	45414		
	fixed RC	D321 @	■	■	■	■	= C630N REM fixed FC + 1 set of rear connections	
		D401 @	■	■	■	■		per pole 44800
		D500 and D630	■	■	■	■		
	plug-in FC to RC	D321 @ to D630	■	■	■	■	= C630N REM fixed FC + 1 set of plugs ⁽¹⁾ per pole 44802 + 1 plug-in base FC/RC 3P 44817 4P 44818 + 1 set of short term. shields 3P 44829 4P 44830	
Visucompact C630H REM*	fixed FC	D321 @	■	■	■	■	= C630H fixed FC + 1 Vigi module REM401/400/630	
		D401 @	45387	45388	45389	■		3P 44430 4P 44431
		D500	45391	45392	45393	45394		
		D630	45395	45396	45397	45398		
	fixed RC	D321 @	■	■	■	■	= C630H REM fixed FC + 1 set of rear connections	
		D401 @	■	■	■	■		per pole 44800
		D500 and D630	■	■	■	■		
	plug-in FC to RC	D321 @ to D630	■	■	■	■	= C630H REM fixed FC + 1 set of plugs ⁽¹⁾ per pole 44802 + 1 plug-in base FC/RC 3P 44817 4P 44818 + 1 set of short term. shields 3P 44829 4P 44830	
Visucompact C630L REM*	fixed FC	D321 @	■	■	■	■	= C630L fixed FC with spacing supports + 1 Vigi module REM401/400/630	
		D401 @	45420	45424	45428	■		3P 44430 4P 44431
		D500	45421	45425	45429	45433		
		D630	45422	45426	45430	45434		
	fixed RC	D321 @	■	■	■	■	= C630L REM fixed FC, with spacing supports + 1 set of connections for supports per pole 44839 + 1 set of rear connections per pole 44800	
		D401 @	■	■	■	■		
		D500 and D630	■	■	■	■		
	plug-in FC to RC	D321 @ to D630	■	■	■	■	= C630L REM fixed FC with spacing supports + 1 set of connections for supports per pole 44839 + 1 set of plugs ⁽¹⁾ per pole 44802 + 1 plug-in base FC/RC 3P 44817 4P 44818 + 1 set of short term. shields 3P 44829 4P 44830	

**Compact C630N/H/L
with a Vigirex RCD
and a separate
toroid**

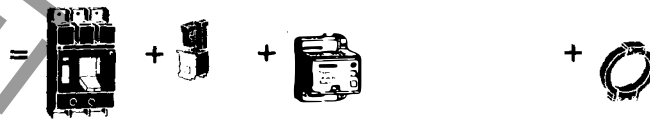

Compact fixed or plug-in
(see previous page)

voltage release
(see page electrical auxiliaries)



Vigirex RCD		
RH50	220/240 V	50040
	220/240 V	50041
	inherent safety model	
RH53A	220/240 V	50082
	380/415 V	50084

toroidal sensors	
IN Ø 80	50107
MN Ø 120	50108

shielded wire (2 conductors)	
l = 100 m	50136

part numbers
C630N/H/L ST

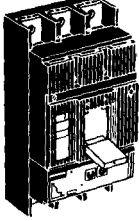
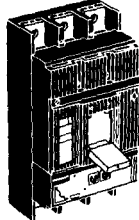
Compact mccb's
C630N/H/L ST
with ST control unit

		complete breaker...				... consisting of:	
		rating	3P 3t	4P 3t	4t	3t + N/2	
 <p>with built-in solid state release</p>	fixed FC	ST204S	45500	45501	45502	45503	
	fixed RC	ST204S	45506	45507	45508	45509	= C630N ST fixed FC + 1 set of rear connections per pole 44800
	plug-in FC RC	ST204S	45518	45519	45520	45521	= C630N ST fixed FC + 1 set of plugs ⁽¹⁾ per pole 44802 + 1 plug-in base FC/RC 3P 44810 4P 44811 + 1 set of short term. shields 3P 44829 4P 44830
 <p>with built-in solid state release</p>	fixed FC	ST204S	45530	45531	45532	45533	
	fixed RC	ST204S	45536	45537	45538	45539	= C630H ST fixed FC + 1 set of rear connections per pole 44800
	plug-in FC RC	ST204S	45548	45549	45550	45551	= C630H ST fixed FC + 1 set of plugs ⁽¹⁾ per pole 44802 + 1 plug-in base FC/RC 3P 44810 4P 44811 + 1 set of short term. shields 3P 44829 4P 44830
 <p>with built-in solid state release</p>	fixed FC	ST204S ST204SB	45561 45560	45562 45590	45563 45566	45564 45591	
	fixed RC	ST204S ST204SB	45566 45570	45567 45592	45568 44571	45569 45593	= C630L ST fixed FC with spacing supports + 1 set of connections for supports per pole 44839 + 1 set of rear connections per pole 44800
	plug-in FC RC	ST204S ST204SB	45572 45576	45573 45578	45574 44577	45575 45579	= C630L ST fixed FC with spacing supports + 1 set of connections for supports per pole 44839 + 1 set of plugs ⁽¹⁾ per pole 44802 + 1 plug-in base FC/RC 3P 44810 4P 44811 + 1 set of short term. shields 3P 44829 4P 44830

Vigicompact C630N/H/L ST Compact C630N/H/L ST with Vigirex RCD

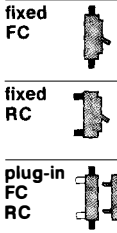
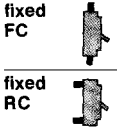
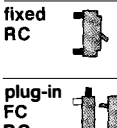
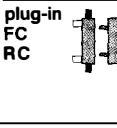
		complete breaker...				... consisting of:	
		rating	3P 3t	4P 3t 4t	3t + N/2		
	fixed FC	ST204S	45437	45438 45439	45440	= C630N ST fixed FC + 1 Vigi module REM401/400/630	3P 44430 4P 44431
	fixed RC	ST204S	■	■	■	= C630N ST REM fixed FC + 1 set of rear connections	per pole 44800
	plug-in FC RC	ST204S	■	■	■	= C630N ST REM fixed FC + 1 set of plugs ⁽¹⁾ + 1 plug-in base FC/RC + 1 set of short term. shields	per pole 44802 3P 44817 4P 44818 3P 44829 4P 44830
Vigicompact C630H ST REM*		rating	3P 3t	4P 3t 4t	3t + N/2		
	fixed FC	ST204S	45441	45442 45443	45444	= C630H ST fixed FC + 1 Vigi module REM401/400/630	3P 44430 4P 44431
	fixed RC	ST204S	■	■	■	= C630H ST REM fixed FC + 1 set of rear connections	per pole 44800
	plug-in FC RC	ST204S	■	■	■	= C630H ST REM fixed FC + 1 set of plugs ⁽¹⁾ + 1 plug-in base FC/RC + 1 set of short term. shields	per pole 44802 3P 44817 4P 44818 3P 44829 4P 44830
Vigicompact C630L ST REM*		rating	3P 3t	4P 3t 4t	3t + N/2		
	fixed FC	ST204S	45445	45446 45447	45448	= C630L ST fixed FC with spacing supports + 1 Vigi module REM401/400/630	3P 44430 4P 44431
		ST204SB	■	■	■		
	fixed RC	ST204S	■	■	■	= C630L ST REM fixed FC, with spacing supports + 1 set of connections for supports + 1 set of rear connections	per pole 44839 per pole 44800
		ST204SB	■	■	■		
	plug-in FC RC	ST204S	■	■	■	= C630L ST REM fixed FC with spacing supports + 1 set of connections for supports + 1 set of plugs ⁽¹⁾ + plug-in base FC/RC + 1 set of short term. shields	per pole 44839 3P 44802 3P 44817 4P 44818 3P 44829 4P 44830
		ST204SB	■	■	■		

**Compact C630N/H/L ST
with a Vigirex RCD
and a separate
toroid**

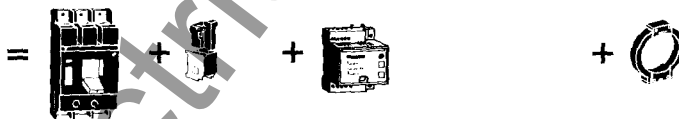

Compact fixed or plug-in
(see previous page)

voltage release
(see page electrical auxiliaries)

Vigirex RCD		
RH50	220/240 V	50040
	220/240 V	50041
	inherent safety model	
RH53A	220/240 V	50082
	380/415 V	50084





toroidal sensors	
IN Ø 80	50107
MN Ø 120	50108

shielded wire (2 conductors)	
l = 100 m	50136

part numbers C630N/H/L and C630N/H/L ST

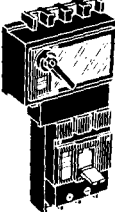
Visucompact mccb's
C630N/H/L
and C630N/H/L ST

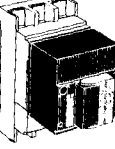

		complete breaker...				...consisting of:	
		rating	3P 3t	4P 3t	4t	3t+N/2	
	fixed FC	D321 @ to D630	■	■	■	■	= C630N fixed FC + 1 Visu module V630 3P 45385 4P 45386
	fixed RC	D321 @ to D630	■	■	■	■	= Visucompact C6300N fixed FC + 1 set of rear connections per pole 44800
<hr/>							
Visucompact C630N ST*		rating	3P 3t	4P 3t	4t	3t+N/2	
	fixed FC	ST204S	■	■	■	■	= C630N ST fixed FC + 1 Visu module V630 3P 45385 4P 45386
	fixed RC	ST204S	■	■	■	■	= Visucompact C630N ST fixed FC + 1 set of rear connections per pole 44800
<hr/>							
earth leakage Visucompact C630N REM*		rating	3P 3t	4P 3t	4t	3t+N/2	
	fixed FC	D321 @ to D630	■	■	■	■	= Visucompact C630N fixed FC + 1 Vigi module REM400/630 3P 44430 4P 44431
	fixed RC	D321 @ to D630	■	■	■	■	
<hr/>							
earth leakage Visucompact C630N ST REM*		rating	3P 3t	4P 3t	4t	3t+N/2	
	fixed FC	ST204S	■	■	■	■	= Visucompact C630N ST fixed FC/RC + 1 Vigi module REM400/630 3P 44430 4P 44431
	fixed RC	ST204S	■	■	■	■	
<hr/>							
auxiliaries and accessories specific to the Visucompact		auxiliary double-throw switch		OF standard or CAM early break depending on mounting		42906	
				2 OF		47757	
		earthing switch for neutral in open position (compulsory if the transformer neutral is earthed on the load side of the Visucompact)				44413	
		locking of the Visu module in open position		by 3 padlock (not supplied)		built-in	
				by Ronis key lock 1351-500 (supplied)		41940	
				by Profalux key lock KS5 B24 D4Z (supplied)		42888	
		terminal shields for Visucompact or earth leakage Visucompact		long terminal shields for FC (1 set)		3P 44833 4P 44832	
				short terminal		3P 44834 4P 44830	
		connection		same as fixed Compact			
Compact NI type (load break switches)						page 112	
automatic and manual source changeover Compact						page 101	
adaptable motor mechanism T630		AC 50/60 Hz (V)		DC (V)			
		120/127 ⁽¹⁾		24 ⁽¹⁾		44970	
		220/240 ⁽¹⁾		48/60 ⁽¹⁾		44971	
		380/415 ⁽²⁾		110/125 ⁽¹⁾		44972	
		440/480 ⁽²⁾		220/250 ⁽¹⁾		44973	
							
adaptable motor mechanism TS630		AC 50/60 Hz (V)		DC (V)			
		110/127 ⁽¹⁾		110/125 ⁽¹⁾		44982	
		220/240 ⁽¹⁾				44985	
accessories for motor mechanism		SDE alarm switch				44906	
		sealable cover				42974	
		locking of the motor mech. ⁽¹⁾ by 1 key lock (not supplied)				44876	
		Ronis 1351.500 or Profalux KS5 B24 D4Z					

(1) Direct supply motor mechanism.
(2) Motor mechanism supplied through an additional resistor.

Compact mccb's C630N/H/L and C630N/H/L ST: auxiliaries, accessories, connections, spare parts

electrical auxiliaries

auxiliary double-throw switches

	1 OF + 1 SD	44900
	3 OF + 1 SD	44901
	1 CAM (for rotary handle or Visu module)	44827

voltage release (for remote tripping)

	MX (shunt trip) AC 50/60 Hz or DC (V)	
	24	44910
	48/60	44911
	110/130	44912
	220/300	44913
	380/480	44914

	MN (undervoltage release) AC 50 Hz DC (V) (V)	
	48 44919 24 44923	
	110/130 44925 30 44917	
	220/240 44926 48 44924	
	380/415 44932 110/130 44925	
		250 44926
		300 44932

AC 60 Hz (V)

110/127	44925
220/240	44926
440	44649

MN (with time delay relay)

220 V AC 50/60 Hz = MN 110/130 V DC + time delay relay 250/700 ms	44925 + 44930
---	--

auxiliary wire block (see quantity p. 55)



moving part

short wires	3 term.	42942
for types N/H	6 term.	42943
long wires	3 term.	42944
for type L	6 term.	42945

fixed part

for all types	3 term.	42940
	6 term.	42941
pack of 24 female clips		42946

accessories

chassis for plug-in CB

for Compact without motor mechanism

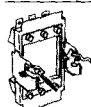
	C630N/H or	3P	44892
	C630N/H ST	4P	44893
	plug-in FC/RC		
	C630L or	3P	44894
	C630L ST	4P	44895
	plug-in FC/RC		

for Compact with motor mechanism

C630N/H or	3P	44896
C630N/H ST	4P	44897
plug-in FC/RC		
C630L or	3P	44898
C630L ST	4P	44899
plug-in FC/RC		

horizontal chassis: consult us

auxiliaries specific to the chassis

auxiliary switches

indicator for draw-out position	39965
indicator for draw-in position	39966

locking in draw-out position with 1 key lock

(supplied Ronis 1351.500)	41929
Profalux KS5 B24 D4Z	41930

locking in draw-in and draw-out position with 1 key lock (supplied)

Ronis 1351.500	41947
Profalux KS5 B24 GAZ	41948

watertight escutcheon for manual operation through the door

	44904
--	--------------

disconnectable auxiliary wire block for



direct rotary handle

with black toggle	44820
red toggle	44847
watertight escutcheon	44940

extended rotary handle

with door locking

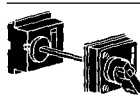

front door mounting	
short shaft	44821
(= 44820 + 42882)	
long shaft	44835
(= 44820 + 42884)	

rear door mounting

short shaft	44837
(= 44820 + 42889)	
long shaft	44840
(= 44820 + 42897)	

without door locking

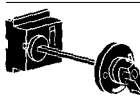

front door mounting	
short shaft	44828
(= 44820 + 45853)	

accessories for converting direct rotary handle to extended handle

with door locking

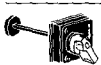

front door mounting	
short shaft	42882
long shaft	42884

rear door mounting

short shaft	42889
long shaft	42897

without door locking

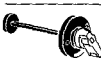

short shaft	45853
-------------	--------------

shaft bracket



for short shaft (always included on rotary handles with long shaft)	42868
--	--------------

locking by padlocks or key lock



of the rotary handle (circuit-breaker in OFF position)	
by 3 padlocks (not supplied)	built-in
1 Ronis key lock 1351.500	41940
1 Profalux key lock KS5 B24 D4Z	42888

of the toggle (in OFF position)	
by 3 padlocks (not supplied)	44936

mechanical interlocking

(for breakers with rotary handle)

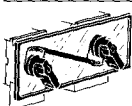

mechanical device	44826
-------------------	--------------

key locks interlocking

(for breakers with rotary handle)

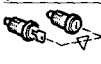

1 set of 2 Ronis 1351.500 key locks (1 single key)	41950
1 set of 2 Profalux KS5 B24 D4Z key locks (1 single key)	42878

sealing accessories



for release, adjustment, cover	44937
for ST release	44587

circuit label holder



pack of 10	42976
------------	--------------

cut-out grommet for door



Compact fixed or plug-in without motor mechanism	44938
with motor mechanism	43745

tight bellows



for toggle (IP43)	44965
-------------------	--------------

locator



for plug-in Compact	43816
---------------------	--------------

sealable terminal shields



short term. shields	2P/3P	44829
	4P	44830
long term. shields	2P/3P	44831
	4P	44832
protective shield	2P/3P/4P	44836
for plug-in base		

connection (see p. 61)

connectors for bare cables

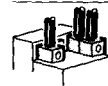

single connector per pole	44813
for 1 cable $70^{\circ} \leq S \leq 300^{\circ}$	44830
double connector per pole	44814
for 2 cables $70^{\circ} \leq S \leq 240^{\circ}$	

angle terminals

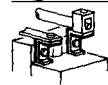

for fixed FC version	per pole	44815
(long terminal shields compulsory)		

spreader



for fixed FC or	3P	44841
plug-in FC/RC version	4P	44842

spare parts



cover	2P/3P/4P	44960
-------	----------	--------------



toggle extension	44964
------------------	--------------



black toggle for:	
rotary handle	44846
Visu module V400/630	45858

part numbers C801N/H/L ST and C1001N/H/L ST

Compact C801N/H/L
with ST control unit



Compact C801N

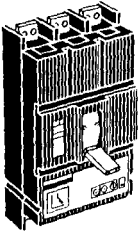

complete breaker...		rating				... consisting of:	
		3P 3t	4P 3t	4t	3t + N/2		
fixed FC		STR 25 DE	46600	46601	46602	46603	= C801N without control unit 3P 46101 4P 46102 + STR 25 DE control unit (see p. 96) + neutral CT for 4P 4t 46220 or for 4P 3t + N/2 46223
fixed RC		STR 25 DE	■	■	■	■	= C801N complete fixed FC + rear connections 1 piece 46958
drawout RC		flat pads					= C801N complete fixed FC ⁽¹⁾ + moving chassis 3P 46824 4P 46825 + fixed chassis 3P 46820 4P 46821 + pads flat 1 piece 46990 or edgewise 1 piece 46988 + 1 set of plugs per pole 46896 + 1 set of short terminal shields 3P 46993 4P 46992
universal chassis		edgewise pads					
		STR 25 DE	46630	46631	46632	46633	
		STR 25 DE	46660	46661	46662	46663	

Compact C801H

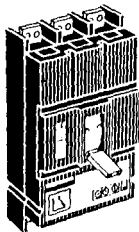

complete breaker...		rating				... consisting of:	
		3P 3t	4P 3t	4t	3t + N/2		
fixed FC		STR 25 DE	46605	46606	46607	46608	= C801H without trip unit 3P 46104 4P 46105 + STR 25 DE control unit (see p. 96) + neutral CT for 4P 4t 46220 or for 4P 3t + N/2 46223
fixed RC		STR 25 DE	■	■	■	■	= C801H complete fixed FC + rear connections 1 piece 46958
drawout RC		flat pads					= C801H complete fixed FC ⁽¹⁾ + moving chassis 3P 46824 4P 46825 + fixed chassis 3P 46820 4P 46821 + pads flat 1 piece 46990 or edgewise 1 piece 46988 + 1 set of plugs per pole 46896 + 1 set of short terminal shields 3P 46993 4P 46992
universal chassis		edgewise pads					
		STR 25 DE	46635	46636	46637	46638	
		STR 25 DE	46665	46666	46667	46668	

Compact C801L





complete breaker...		rating				... consisting of:	
		3P 3t	4P 3t	4t	3t + N/2		
fixed FC		STR 25 DE	46690	46691	46692	46693	= C801L without control unit 3P 46119 4P 46120 + STR 25 DE control unit (see p. 96) + neutral CT for 4P 4t 46220 or for 4P 3t + N/2 46223
fixed RC		STR 25 DE	■	■	■	■	= C801L complete fixed FC + rear connections flat 1 piece 46916 or edgewise 46913
drawout RC		flat pads					= C801L complete fixed FC ⁽¹⁾ + moving chassis 3P 46824 4P 46825 + fixed chassis 3P 46822 4P 46823 + pads flat 1 piece 46990 or edgewise 1 piece 46988 + 1 set of plugs per pole 46915 + 1 set of short terminal shields 3P 46993 4P 46992
universal chassis		edgewise pads					
		STR 25 DE	46695	46696	46697	46698	
		STR 25 DE	46700	46701	46702	46703	

www.ElectronicParts.com

Compact C1001N/H/L with ST control units

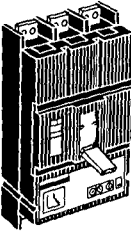

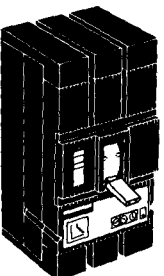

		complete breaker...				...consisting of:	
		rating	3P 3t	4P 3t	4t	3t+N/2	
	fixed FC	STR 25 DE	46610	46611	46612	46613	= C1001N without control unit 3P 46107 4P 46108 + STR 25 DE control unit (see p. 96) + neutral CT for 4P 4t 46221 or for 4P 3t+N/2 46223
	fixed RC	STR 25 DE	■	■	■	■	= C1001N complete fixed FC + rear connections 1 piece 46958
	drawout RC universal chassis	flat pads STR 25 DE	46640	46641	46642	46643	= C1001N complete fixed FC ⁽¹⁾ + moving chassis 3P 46824 4P 46825 + fixed chassis 3P 46820 4P 46821 + pads flat 1 piece 46990 or edgewise 1 piece 46988 + 1 set of plugs per pole 46896 + 1 set of short terminal shields 3P 46993 4P 46992
	edgewise pads STR 25 DE	46670	46671	46672	46673		
	fixed FC	STR 25 DE	46615	46616	46617	46618	= C1001H without control unit 3P 46104 4P 46105 + STR 25 DE control unit (see p. 96) + neutral CT for 4P 4t 46221 or for 4P 3t+N/2 46223
	fixed RC	STR 25 DE	■	■	■	■	= C1001H complete fixed FC + rear connections 1 piece 46958
	drawout RC universal chassis	flat pads STR 25 DE	46645	46646	46647	46648	= C1001H complete fixed FC ⁽¹⁾ + moving chassis 3P 46824 4P 46825 + fixed chassis 3P 46820 4P 46821 + pads flat 1 piece 46990 or edgewise 1 piece 46988 + 1 set of plugs per pole 46896 + 1 set of short terminal shields 3P 46993 4P 46992
	edgewise pads STR 25 DE	46675	46676	46677	46678		
	fixed FC	STR 25 DE	46705	46706	46707	46708	= C1001L without control unit 3P 46112 4P 46123 + STR 25 DE control unit (see p. 96) + neutral CT for 4P 4t 46221 or for 4P 3t+N/2 46223
	fixed RC	STR 25 DE	■	■	■	■	= C1001L complete fixed FC + rear connections flat 1 piece 46916 or edgewise 46913
	drawout RC universal chassis	flat pads STR 25 DE	46710	46711	46712	46713	= C1001L complete fixed FC ⁽¹⁾ + moving chassis 3P 46824 4P 46825 + fixed chassis 3P 46822 4P 46823 + pads flat 1 piece 46990 or edgewise 1 piece 46988 + 1 set of plugs per pole 46915 + 1 set of short terminal shields 3P 46993 4P 46992
	edgewise pads STR 25 DE	46715	46716	46717	46718		



www.ElectricalPart.com

part numbers C801N/H/L to C1251N/H

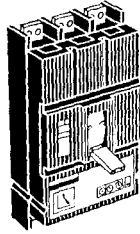
Compact mccb's C1251N/H ST
ST control for C801N/H/L ST
to C1251N/H ST
remote control

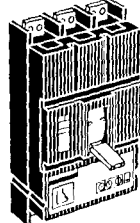

complete breaker...					... consisting of:	
	rating	3P 3t	4P 3t	4t	3t+N/2	
 fixed FC	STR 25 DE	46620	46621	46622	46623	= C1251N without control unit 3P 46113 4P 46114 + STR 25 DE control unit (see below) + neutral CT for 4P 4t 46222 or for 4P 3t + N/2 46223
	STR 25 DE	■	■	■	■	= C1251N complete fixed FC + rear connections 1 piece 46958
 drawout RC universal chassis	flat pads					= C1251N complete fixed FC ⁽¹⁾
	STR 25 DE	46650	46651	46652	46653	+ moving chassis 3P 46824 4P 46825 + fixed chassis 3P 46820 4P 46821 + pads flat 1 piece 46990 or edgewise 1 piece 46988
	STR 25 DE	46680	46681	46682	46683	+ 1 set of plugs per pole 46896 + 1 set of short terminal shields 3P 46993 4P 46992

complete breaker...					... consisting of:	
	rating	3P 3t	4P 3t	4t	3t+N/2	
 fixed FC	STR 25 DE	46625	46626	46627	46628	= C1251H without control unit 3P 46116 4P 46117 + STR 25 DE control unit (see below) + neutral CT for 4P 4t 46222 or for 4P 3t + N/2 46223
	STR 25 DE	■	■	■	■	= C1251H complete fixed FC + rear connections 1 piece 46958
 drawout RC universal chassis	flat pads					= C1251H complete fixed FC ⁽¹⁾
	STR 25 DE	46635	46636	46637	46638	+ moving chassis 3P 46824 4P 46825 + fixed chassis 3P 46820 4P 46821 + pads flat 1 piece 46990 or edgewise 1 piece 46988
	STR 25 DE	46665	46666	46667	46668	+ 1 set of plugs per pole 46896 + 1 set of short terminal shields 3P 46993 4P 46992

C801/C1001/C1251 ST circuit breakers without release (fixed front connections)								
C801N	3P	46101	C1001N	3P	46107	C1251N	3P	46113
C801N	4P	46102	C1001N	4P	46108	C1251N	4P	46114
C801H	3P	46104	C1001H	3P	46110	C1251H	3P	46116
C801H	4P	46105	C1001H	4P	46111	C1251H	4P	46117
C801L	3P	46119	C1001L	3P	46122			
C801L	4P	46120	C1001L	4P	46123			

to complete with: ST TRIP units...			
Basic offer		Evolutive option offer	
STR 25 DE	46500	STR 55 UE FC	46520
STR 25 DE f-s	46501	STR 55 UE RFC	46522
STR 35 SE	46504	STR 55 UE TFC	46524
STR 35 ME	46505	STR 55 UE TRFC	46525
STR 35 GE	46506	STR 45 BE C	46527
STR 55 UE	46512	STR 45 BE RC	46528
Integrated option offer		STR 45 BE TC	46529
STR 55 UE RF	46516	STR 45 BE TRC	46530
STR 55 UE TRF	46517	Zone sel. interlock Z	46485 ⁽²⁾

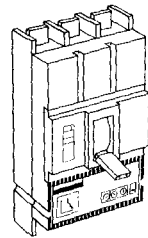

C801/C1001/C1251 ST circuit breakers without release ST control units

www.electricalpartsnails.com

**Compact C801N/H/L ST
to C1251N/H ST:
remote control
Compact C801N/H/L ST
to C1251N/H ST
with Vigirex RCD**

**Compact
with a Vigirex RCD
and a separate
toroid**

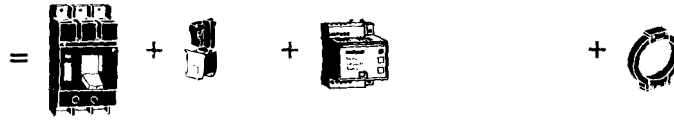

**Compact
fixed or
plug-in**
(see above)

**voltage
release**
(see page
electrical
auxiliaries)

Vigirex RCD		
RH50	220/240 V	50040
	220/240 V	50041
	inherent safety model	
RH53A	220/240 V	50082
	380/415 V	50084

toroidal sensor	
MN Ø 120	50108
SN Ø 200	50109

shielded wire (2 conductors)	
l = 100 m	50136

Compact NI type (load break switches) page 112

automatic and manual source changeover Compact page 99

**adaptable motor mechanism
T801 to T1251**

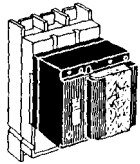

AC 50/60 Hz (V)		DC (V)	
110/127 ⁽¹⁾	46928	24 ⁽¹⁾	46917
220/240 ⁽¹⁾	46929	48/60 ⁽¹⁾	46918
380/415 ⁽²⁾	46930	110/125 ⁽¹⁾	46919
440/480 ⁽²⁾	46931	220/250 ⁽¹⁾	46920

**adaptable motor mechanism
TS801 to TS1251**

AC 50/60 Hz (V)		DC (V)	
110/127 ⁽¹⁾	46876	110/125 ⁽¹⁾	46874
220/240 ⁽¹⁾	46877	24/30 ⁽¹⁾	46879

Accessories for motor mechanism

SDE alarm switch	46962
sealable cover	(consult us)
locking of the motor mech. (1) by 1 key lock (not supplied)	44876
Ronis 1351.500 A or Profalux KS5 B24 D4Z	

part numbers C801N/H/L ST to C1251N/H ST

Compact mccb's C801N/H/L ST to C1251N/H ST auxiliaries, accessories connection, spare parts





electrical auxiliaries

auxiliary switches

	1 OF + 1 SD	44900
	3 OF + 1 SD	44901
	1 CAM (for rotary handle or Visu module)	44827
double-throw micro-switches		
	"plugged-in" position	46963
	"withdrawn" position	46964

voltage releases (for remote tripping)

	MX (shunt trip)	
	AC 50/60 Hz or DC (V)	
	24	44910
	48/60	44911
	110/130	44912
	220/300	44913
	380/480	44914

	MN (undervoltage release)	
	AC 50 Hz (V)	DC (V)
	48	44919 24 44923
	110/130	44925 30 44917
	220/240	44926 48 44924
	380/415	44932 110/130 44925
		250 44926
		300 44932

AC 60 Hz (V)		
110/127	44925	
220/240	44926	
440	44649	

MN (with time delay relay)		
220 V AC 50/60 Hz		
= MN 110/130 V DC		
+ time delay relay		44925
250/700 ms		44930

auxiliary wire block (see quantity p. 55)

	moving part	
	short wires	3 term. 42942
	for types N/H	6 term. 42943
	long wire	3 term. 42944
	for type L	6 term. 42945
fixed part		
	for all types	3 term. 42940
		6 term. 42941
	pack of 24 female clips	42946

accessories

direct rotary handle

	with black toggle	46933
---	-------------------	-------

extended rotary handle

with door locking		
front door mounting		
	short shaft	46935
	(= 46933 + 42882)	
	long shaft	46937
	(= 46933 + 42884)	
rear door mounting		
	short shaft	46871
	(= 46933 + 42889)	
	long shaft	46872
	(= 46933 + 42897)	

without door locking

front door mounting		
	short shaft	46938
	(= 46933 + 45853)	

accessories for converting direct rotary handle to extended handle

with door locking		
front door mounting		
	short shaft	42882
	long shaft	42884
rear door mounting		
	short shaft	42889
	long shaft	42897

without door locking

	short shaft	45853
---	-------------	-------

shaft bracket

	for short shaft	42868
	(always included on rotary handles with long shaft)	

locking by padlocks or key lock

of the rotary handle		
(circuit-breaker in "OFF" position)		
by 3 padlocks (not supplied) built-in		
	1 Ronis key lock 1351.500	41940
	1 Profalux key lock KS5 B24 D4Z	42888

for withdrawable circuit-breaker		
locking device for 1 or 2		
keylocks (not supplied)		

keylocks for locking in draw-out position (free key)		
	1 keylock Ronis 1351.500	41940
	Profalux KS5 B24 D4Z	42888
	1 set of 2 keylocks (1 key only)	
	Ronis 1351.500	41950
	Profalux KS B24 D4Z	42878

keylocks for locking in draw-in position (free key)		
	1 key Ronis 1351.500	41945
	Profalux KS5 B24 D4Z	42900

of the toggle		
(in "OFF" position)		
by 3 padlocks (not supplied)		
		44936

mechanical interlocking

(for fixed breakers with rotary handle)		
	mechanical device	46946

key locks interlocking (for breakers with rotary handle and withdrawable breakers)

	1 set of 2 key locks Ronis 1351.500 (1 key only)	41950
	1 set of 2 key locks Profalux KS5 B24 D4Z (1 key only)	42878

sealing accessories

	for release, adjustment cover	46939 44937
---	-------------------------------	-------------

circuit label-holder

	set of 10	42976
---	-----------	-------

door cut-out grommet

	for fixed breaker	44938
---	-------------------	-------

sealable terminal shields

	short 3P	46993
	(1 line side 4P or load side)	46992
	long 3P	46999
	(1 line side 4P or load side)	46995



connection (see p. 62)

connectors for 4 Cu or Al cables 70 ≤ S ≤ 240



	1 set with 3P	46960
	long terminal shield 4P	46994
	(line side or load side)	

connection pads

	for fixed FC Compact N/H/L edgewise pads 1 piece	46988
---	--	-------

	for fixed RC Compact N/H edgewise pads 1 piece	46958
	for fixed RC Compact L flat pads 1 piece	46916
	edgewise pads 1 piece	46913
	complementary pads for cables	46902

testing devices

	testing kit	55651
	testing unit	43362
	+ adaptor for STR control unit	46900

spare parts

	cover	3P/4P 46997
---	-------	-------------

	extended toggle: short	46998
	long	46996

	black toggle for: rotary handle	46970
	Visu module V800	47759
	red toggle for: rotary handle	46971



www.Electrical.com



**Compact mccb's
C801N/H/L ST to C1251N/H ST
standard chassis
auxiliaries, accessories and
connections for draw-out
versions**

standard chassis for C801N/H/L to C1251N/H Ⓞ

complete chassis...					...to complete with:
		3P 3t	4P 3t 4t	3t+N/2	
plug-in FC RC		for C801N/H for C1001N/H for C1251N/H	46851 46853 46853 46853		1 C801N/H/L or C1001N/H/L or 1 C1251N/H FC/RC + 1 set of plugs per pole 46896 + pads flat 1 piece 46990 or edgewise 1 piece 46988 + terminal shields (1 piece) 3P 46993 4P 46992
		for C801/1001L	46852 46854 46854 46854		



auxiliaries, accessories and connections specific to draw-out versions

		std chassis	univ. chassis
auxiliaries			
auxiliary wire block (see quantity p. 55)	moving part short wire (N/H types)	3 terms 42942	42942
	long wire (L type)	6 terms 42943	42943
		3 terms 42944	42944
		6 terms 42945	42945
	fixed part for all types	3 terms 42940	42940
		6 terms 42941	42941
	pack of 24 female clips	42946	42946
trip unit options wire block (10 wires)			
	moving part (long wire for N/H/L types)	46894	46894 Ⓞ
	fixed part (for all types)	46893	46893 Ⓞ
connection set of auxiliaries (replaces the standard auxiliary wire blocks)			
	connection set (6 wires) with striker extension	46841	46989
	additional connection set (6 wires)	41928	41928
auxiliary switches			
	indicator for draw-out position	39965	46837
	indicator for draw-in position	46963	46963
closing devices IP 20 for auxiliary wire block			
	1 set	39967	39967
accessories			
	door frame for chassis (IP 40)		46830 Ⓞ
	door cut-out grommet (IP40)	46977	
	door frame with porthole and grommet for standard toggle	46831	46831 Ⓞ
	door frame with porthole and grommet for rotary handle	46832	46832 Ⓞ
	locking in draw-out position (lock supplied - 1 key) Ronis 1351 B	41929	
	Profalux KS5 B24 D4Z	41930	
	locking in draw-in, out position (lock supplied - 1 key) Ronis 1351 A	41947	
	Profalux KS5 B24 G4Z	41948	
	locking for 1 or 2 locks Ronis or Profalux (not supplied)		46833 Ⓞ
	door interlock		46834 Ⓞ
	racking interlock		46835 Ⓞ
	Castell locking (key lock not supplied)		46838 Ⓞ
	Kirk locking (key lock not supplied)		46836 Ⓞ
	insulating shutter IP40 (1 unit)	46987	46987
	key locks		
	1 key lock Ronis 1351.500 (key free)		41940
	Profalux KS5 B24 D4Z (key free)		42888
	1 additional key lock Ronis 1351.A*		41945
	Profalux KS5 B24 G4Z*		42900
	(additional key lock enables to prevent locking by main key lock)		

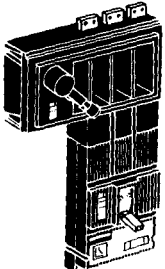

part numbers C801N/H/L to C1251N/H

Visucompact mccb's
C801N to C1251N

fixed Visucompact

		complete breaker...				...consisting of:
		rating	3P 3t	4P 3t	4t	3t + N/2
	fixed FC		■	■	■	■
= C801N ST complete fixed FC (see page 94) + Visu module V801 with intermediate cover 3P 46907 4P 46908 without cover or accessories(1) 3P 46940 4P 46941						
	fixed FC		■	■	■	■
= C1001N ST complete fixed FC (see page 95) + Visu module V1251 with intermediate cover 3P 46909 4P 46910 without cover or accessories(1) 3P 46942 4P 46943						
	fixed FC		■	■	■	■
= C1251N ST complete fixed FC (see page 96) + visu module V1251 with intermediate cover 3P 46909 4P 46910 without cover or accessories(1) 3P 46942 4P 46943						

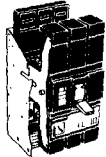
drawout Visucompact

		rating	3P 3t	4P 3t	4t	3t + N/2
	drawout RC		■	■	■	■
	flat pads		■	■	■	■
	edgewise pads		■	■	■	■
= C801N ST fixed FC (see page 94) + moving chassis 3P 46824 4P 46825 + fixed chassis 3P 46820 4P 46821 + pads flat (1 piece) 46990 or edgewise (1 piece) 46988 + 1 set of plugs (per pole) 46896 + 1 set of short terminal shields 3P 46993 4P 46992 + door frame for chassis 46830 + door frame for standard toggle 46831 or rotary handle 46832 + insulating shutter (1 unit) 46987						
	drawout RC		■	■	■	■
	flat pads		■	■	■	■
	edgewise pads		■	■	■	■
= C1001N ST fixed FC (see page 95) + accessories: as C801N (see above)						
	drawout RC		■	■	■	■
	flat pads		■	■	■	■
	edgewise pads		■	■	■	■
= C1251N ST fixed FC (see page 96) + accessories: as C801N (see above)						

auxiliaries, accessories and connections specific to the fixed Visucompact

auxiliary double-throw switch	OF standard or CAM early break depending on mounting	42906
	2 OF	47757
locking of the Visu module in open position	by 3 padlocks (not supplied)	built-in
	by Ronis key lock 1351-500 (supplied)	41940
	by Profalux key lock KS5 B24 D4Z (supplied)	42888
terminal shields for Visucompact	line side (phase separators)	3P/4P 47756
	load side	3P 46999 4P 46995
connection for Visucompact C801N	line side, same as Interpact IN1000	see page 111
	load side, same as Compact C801N	see page 98
connection for Visucompact C1001N	line side, same as Interpact IN1000	see page 111
	load side, same as Compact C1001N	page 98
connection for Visucompact C1251N	line side, same as Interpact IN1600	see page 111
	load side, same as Compact C1251N	see page 98

part numbers automatic source changeover with C101 to C1251N/H/L

automatic source changeover

constitution



C250N + C250N

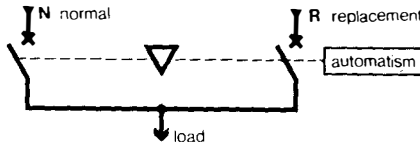

The automatic source changeover is equipped with:

- different types of breakers N, H or L;
- different ratings;
- different trip unit (D, G, SA...).

Note:

- the higher rating is always on the left, on normal incoming;
- for Compact fixed FC, it is possible to associate a type L with a type N/H by using spacing supports which balance the difference of depth⁽⁴⁾.

C101N/H/L - C161N/H/L

	3P	4P	Normal	+ replacement	+ accessories	
fixed FC	■	■	C101N/H/L (see p. 70)	C101N/H/L (see p. 70)	+ 1 plate with interlocking	39815
			C161N/H/L (see p. 74)	C161N/H/L (see p. 74)	+ 2 remote control units for C101N/H/L: T101	220/240 V 39851 380/415 V 39853
					for C161N/H/L: T161	220/240 V 40581 380/415 V 40582
					+ 1 automatism AC 50 Hz ⁽²⁾	220 V 44888 240 V 44891 380 V 44889 415 V 44890
					+ raising accessory (case of C161L x C101N/H/L)	42972

C250N/H/L*

	3P	4P	Normal	+ replacement	+ accessories	
fixed FC	■	■	C250N/H/L ⁽³⁾ (see p. 78)	C250N/H/L (see p. 78)	+ 1 plate with interlocking	43743
					+ 2 motor mechanisms T250	220/240 V ⁽²⁾ AC 50 Hz 2x 43776
					+ 1 automatism AC 50 Hz	220 V 44888 240 V 44891 380 V 44889 415 V 44890

C401/C400/C630N/H/L* C630N/H/L ST*

	3P	4P	Normal	+ replacement	+ accessories	
fixed FC	■	■	C401N/H/L ⁽³⁾ (see p. 76)	C401N/H/L (see p. 76)	+ 1 plate with interlocking	43744
			to	+ C250N/H/L (see p. 78)	+ 1 motor mechanism T400/630	220/240 V ⁽²⁾ AC 50 Hz 44976
			C630N/H/L ST ⁽³⁾ (see p. 90)		+ 1 motor mechanism T250	220/240 V ⁽²⁾ AC 50 Hz 43776
					+ 1 automatism AC 50 Hz	220 V 44888 240 V 44891 380 V 44889 415 V 44890

C400/C630

	3P	4P	Normal	+ replacement	+ accessories	
fixed FC	■	■	C401N/H/L ⁽³⁾ (see p. 82)	C401N/H/L (see p. 82)	+ 1 plate with interlocking	44855
			to	+ to	+ 2 motor mechanisms T400/630	220/240 V ⁽²⁾ AC 50 Hz 2x 44976
			C630N/H/L ST ⁽³⁾ (see p. 90)	C630N/H/L ST (see p. 90)	+ 1 automatism AC 50 Hz	240 V 44888 380 V 44889 415 V 44890

C801N/H ST* C1001N/H ST* C1251N/H ST*

	3P	4P	Normal	+ replacement	+ accessories	
fixed FC	■	■	C801N/H ST (see p. 94)	C801N/H ST (see p. 94)	+ 1 plate with interlocking	46947
			or	or	+ 2 motor mechanisms T801/1001/1251	220/240 V ⁽²⁾ AC 50 Hz 2x 46929
			C1001N/H ST (see p. 95)	C1001N/H ST (see p. 95)	+ 1 automatism AC 50 Hz	220 V 44888 240 V 44891 380 V 44889 415 V 44890
			or	or		
			C1251N/H ST (see p. 96)	C1251N/H ST (see p. 96)		

C801L ST* C1001L ST*

	3P	4P	Normal	+ replacement	+ accessories	
fixed FC	■	■	C801L ST (see p. 94)	C801L ST (see p. 94)	+ 1 plate with interlocking	46947
			or	or	+ 2 motor mechanisms T801/1001/1251	220/240 V ⁽²⁾ AC 50 Hz 2x 46929
			C1001L ST (see p. 95)	C1001L ST (see p. 95)	+ 1 automatism AC 50 Hz	220 V 44888 240 V 44891 380 V 44889 415 V 44890

part numbers manual source changeover with C101 to C1251N/H/L

manual source changeover

with mechanical interlocking



The manual source changeover with mechanical interlocking is composed of:

- 1 mechanical interlocking device
- 2 Compact breakers.

The Compact breakers are installed side by side, on panel or rails, without plate.

It is necessary to equip each breaker with a **direct rotary handle**, for mounting of the mechanism which interlocks the handles. The rating, the trip units and the number of poles of the breakers can be different. On the other hand, the versions (fixed, plug-in, front or rear connected) must be identical.

	3P	4P	Normal	+ replacement	+ accessories	
C101 to C630N/H/L*	fixed FC	■ ■	= C101 to 630N/H/L (see p. 68 to 88)	+ C101 to C630N/H/L (see p. 68 to 88)	+ 1 mechanical interlocking	44826
	fixed RC	■ ■			+ 1 direct rotary handle per switch	C101/C161 41310 C250 43820 C400/630 44820
	plug-in FC RC	■ ■				
C801 to C1251N/H/L ST*	fixed FC	■ ■	= C801 to C1251N/H/L ST (see p. 92 to 94)	+ C801 to C1251N/H/L ST (see p. 92 to 94)	+ 1 mechanical interlocking	46946
	fixed RC	■ ■			+ 1 direct rotary handle per switch	C801 to C1251 46933

with key locks

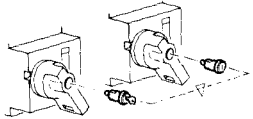

This interlocking is easily set up by the addition, on each breaker, of the locking device, which can be equipped with 2 locks bearing the same key number. The one and only key will lock out only one of the breakers.

	3P	4P	Normal	+ replacement	+ accessories		
C101 to C1251N/H/L	fixed FC	■ ■	= C101 to C1251N/H/L (see p. 68 to 88)	+ C101 to C1251N/H/L (see p. 68 to 88)	+ 1 direct rotary handle per switch	C101/C161 41310 C250 43820 C400/630 44820	
	fixed RC	■ ■					C801 to C1251 46933
	plug-in FC RC	■ ■					+ 1 set of 2 keys locks (1 single key): Ronis 1351.500 41950 Profalux KS5 B24 D4E 42878

load break switches

4 switches, enclosures

	page
Interpact load break switches	106
Compact load break switches	112
Fupact fuse-switches	114
individual enclosures	116

www.ElectricalPartManuals.com



www.ElectricalPartManuals.com

switches 63 to 2500 A

for circuit control

coupling

In the event of a normal supply failure, the switch enables the essential supply feeders, supplied via the standby source to be isolated from the non-essential side of the system.

distribution

As a main incomer of the secondary switchboard, where protection is provided upstream, the switch enables the secondary switchboard to be isolated.

motor control

When fitted to the line side of the motor, the switch provides either local or remote isolation of the motor from the system, for maintenance purposes etc.

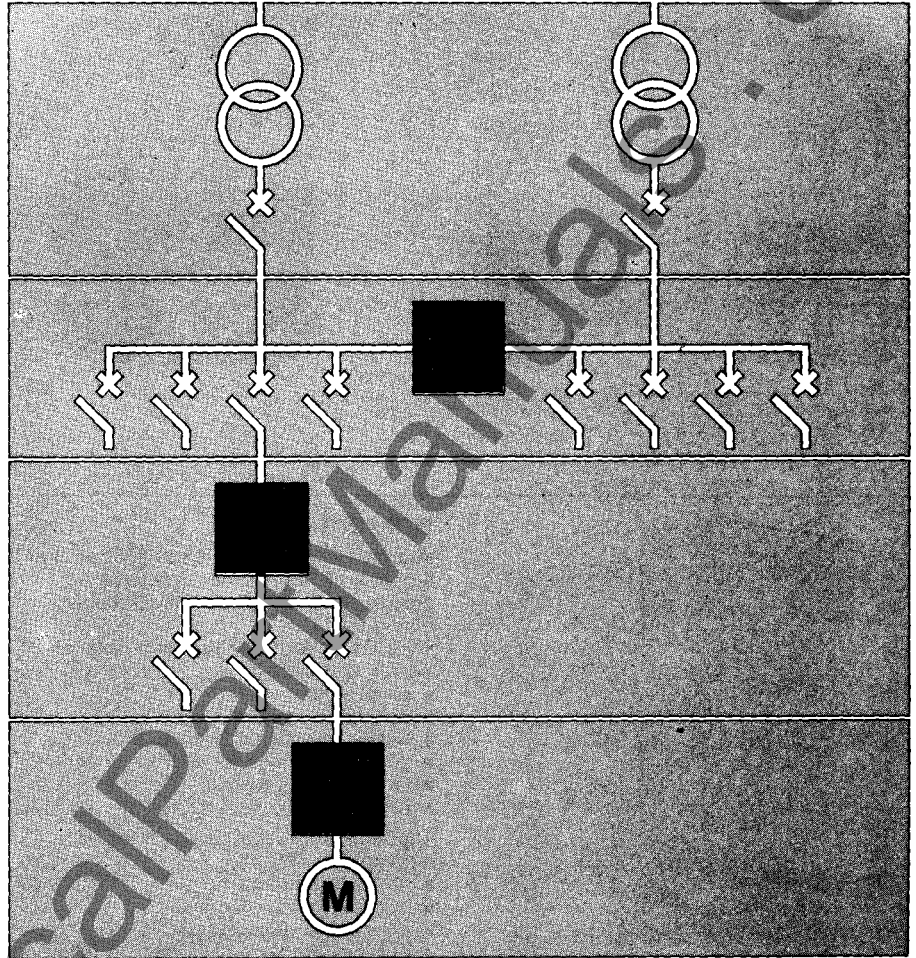

which switch should you choose?

Interpact load break switches

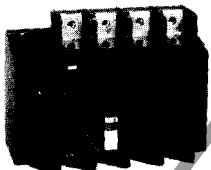

A simple high performance switch specifically designed for isolation and control, the range comes complete with a full range of accessories which include:

- auxiliary contacts for on/off indication and control
- auxiliary for early break
- installation accessories
- 3 and 4 pole versions
- padlocking/changeover facility
- compliance with B.S. etc, AC22/23 rated

IN63T to IN2500

Compact NI load break switches



A high performance switch utilising Moulded Case Circuit Breaker technology and hence offering the advantages of a MCCB, i.e.:

- O.F. auxiliary contact for on/off indication
- CAM switch for early break
- MX shunt trip and MN undervoltage releases
- Vigi module for earth fault protection,
- adaptable remote control facility
- available as source changeover system
- full range of installation accessories
- full range of connection accessories
- padlocking/changeover facility
- compliance with B.S. etc AC22/23 rated
- 3 and 4 pole versions.

C101NI to C1251NI

switches

Interpact load break switches

IN63T to IN2500

description
characteristics

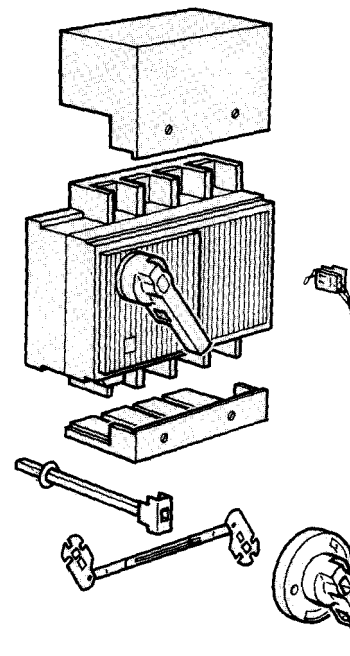
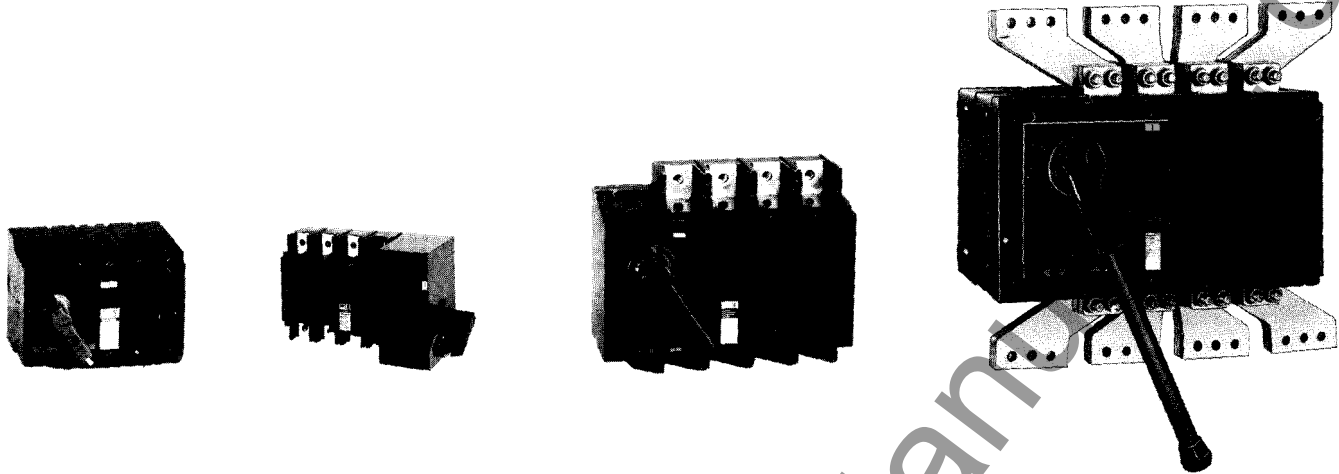

presentation

Interpact is a range of 63 to 2500 A, 3 or 4-pole switches, of moulded case construction with double break contact configuration.

They are used for control and isolation of distribution circuits:

- main switch,
- coupling,
- head of divisional switchboard,
- "motor" circuit control,
- local isolating device,
- etc.

The Interpact range can be fitted with auxiliaries such as:

- auxiliary contacts,
- installation accessories,
- connection accessories,
- etc. (for further details refer to following pages)

positive break indication

All Interpact devices provide isolation with positive break indication.

Their control handle can only indicate the "off" position if all the contacts are indeed open and a proper distance apart.

installation

Interpact switches are installed on a panel or on metal supports, and can operate in all positions.

Degree of protection

bare unit with terminal shields	IP40
unit in enclosure direct handles	IP40
or cubicle with extended handles	IP55

tropicalisation

Interpact switches and their auxiliaries are tropicalised.

They comply with the following standards:

- IEC 68-2-30 Damp heat
- IEC 68-2-2 Dry heat
- IEC 68-2-11 Salt mist
- IEC 68-2-1 Cold temperature withstand.

standards

Interpact switches comply with:

- IEC 408 recommendations,
- French Standard NF C63-130,
- German Standard VDE 0660,
- British Standard BS 5419,
- Italian Standard CEI.

www.electricals.com

auxiliaries and accessories

CAM switch

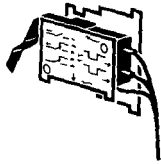

The CAM switch is a common point auxiliary changeover contact which, depending on how it is fitted, can provide:

- either the **OF** function, connected with the Interpact "on" or "off" position,
- or the **CAM** function, for early break or early make (break only on IN63T).

Note: a block with 2 changeover contacts is also available for the IN400 to IN2500 (OF function only).

Possible combinations

Interpact	block		block CAM
	1 OF	2 OF	
IN63T			1
IN125T, IN160T, IN2500	1		+1
IN400, IN630,	1		+1
IN1000, IN1600, IN2500		1	+1

Extended and lateral rotary handle

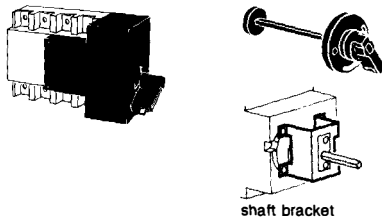

Lateral rotary handle
The standard direct rotary handle on Interpact IN63T to IN160T switches may be converted into a lateral direct rotary handle by an optional accessory kit.

Extended rotary handle (IP557) is obtained by adding to the standard rotary handle an accessory kit comprising:

- an escutcheon to be fitted in front of the door to accommodate the handle

- an extension shaft.

The extended rotary handle does not alter the visible break indication function, and can be optionally fitted with:

- a **shaft bracket** to eliminate vertical play at the end of the shaft.
- a **door latch** which only allows the door to be opened when the handle is in the "open" position.

Locking by padlocks or key lock

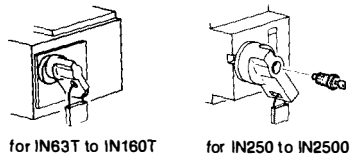

To lock the Interpact in the "open" position, the handle includes:

- a padlock fitting for 3 padlocks (not supplied) built into the toggle of all the Interpact devices (1 padlock only for IN63T);
- a pre-drilled location on the IN250 to IN2500 to fit 1 key lock (supplied as option), with a key held captive when the Interpact is in the "closed" position.

Locking possibilities

Interpact	locking possibilities	
	padlock Ø hasp (mm)	key lock type
IN63T to IN160T	5 to 8	without
IN250	5 to 8	Ronis 1351.500
IN400 to IN630	6 to 8	or Profalux
IN1000 to IN2500	5 to 8	KS5 B24 D4Z

Interlocking

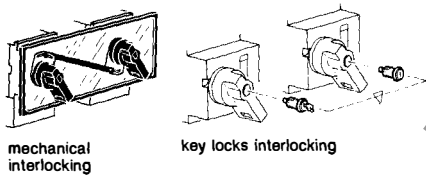

Mechanical interlocking
This interlocking equips the Interpact IN63T to IN630. It is achieved by a mechanism which connects the handles of 2 direct control Interpacts to constitute a manual source changeover. This device prevents both switches from being closed at the same time, but allows them to be opened.

Interlocking by key locks

This interlocking equips the Interpact IN250 to IN2500. Both Interpacts are equipped with a standard interlock associating 2 key locks and a single key. This solution enables 2 geographically distant switches to be interlocked.

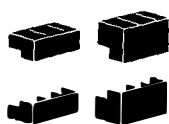

The terminal shields are sealable insulating accessories used to avoid direct contacts with live parts. Depending on the switch type, the Interpact can be fitted:

- either with short or long terminal shields,
- or with phase separators.

The terminal shields are always supplied with their sealing accessories.

Fitting possibilities

Interpact	term. shields		phase separators
	short	long	
IN63T to IN160T	■		
IN250 to IN630	■		
IN1000 to IN2500			■

connection

Direct connection IN63T
bare cables

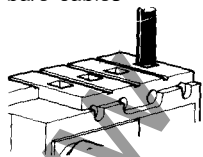

IN125 to IN630
bars or cables with crimped lugs

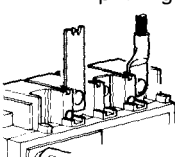

IN1000 and IN1600
bars

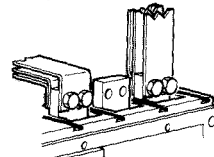

IN2500
bars

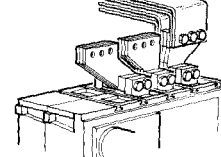

Connection with accessories

Polybloc
for IN125T and IN160T

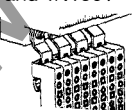

connectors
for IN125T to IN630

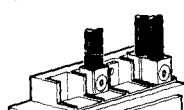

angle terminals
for IN125T to IN630

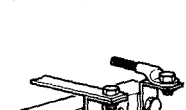

spreader
for IN400 and IN630

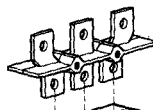

for IN1000 and IN1600

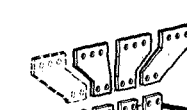

edgewise pads
for IN1000 and IN1600



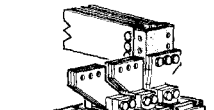

connectors
for IN2500



switches

Interpact load break switches IN63T to IN2500

characteristics

Interpact										
		IN63T	IN125T	IN160T						
characteristics										
rated current (A) at 60 °C		63	125	160						
rated service current (A)	AC 50/60 Hz	cl. AC 22 (U ≤ 400 V)	63	125						
		cl. AC 23 (U ≤ 400 V)	63	125						
	DC	cl. DC 23 (U ≤ 250 V) ⁽¹⁾	63	125						
rated voltage (V)	AC 50/60 Hz	660	660	660						
	DC	500	500	500						
number of poles		3, 4	3, 4	3, 4						
short circuit making current (kA peak)		15	20	20						
withstand current (kA rms for 1 s)		2.5	5.5	5.5						
endurance	mechanical	15000	15000	15000						
	electrical at 415 V	1000	1000	1000						
protection										
upstream protection	Compact circuit breaker ⁽⁶⁾ (Isc max. = breaking capacity of the CB)	NC100 C101N C161N	C161N/L	C161N/H/L						
	aM type fuse ⁽²⁾ max. (A)	63	125	125						
		Isc max. (kA rms)	50	50						
	g1 type fuses max. (A)	80	160	160						
		Isc max. (kA rms)	50	50						
auxiliaries and accessories										
adaptable auxiliaries	OF switches	■	■	■						
	CAM switch	■	■	■						
adaptable auxiliaries	terminal shields	■	■	■						
	connection accessories	■	■	■						
	padlocking device	■	■	■						
	locking device	■	■	■						
	extended rotary handle	■	■	■						
	mechanical interlocking	■	■	■						
	key lock interlocking	■	■	■						
installation										
version	connection	FC	FC	RC	FC	RC				
	fixed	■	■	■	■	■				
overall dimensions (mm)		H	W	D	H	W	D	H	W	D
	3P	85	120	105	128	170	105	128	170	105
	4P	85	120	105	128	170	105	128	170	105
weight (kg)	3P	0.75			1.4			1.4		
	4P	0.80			1.5			1.5		

(1) Number of poles involved in breaking:
1 at 48 V, 2 at 125 V, 4 at 250 V.















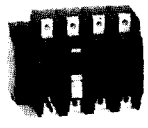







(2) aM fuses must be systematically associated with a thermal release.

(3) Phase separators.

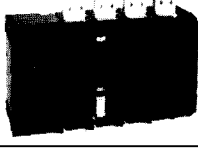
(4) With no time delayed trip unit.

switches
Interpact load break switches
IN63T to IN2500

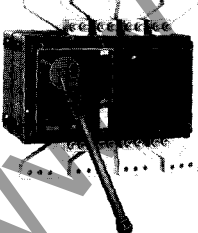
part numbers

		complete switch...	... consisting of		
	IN63T	fixed FC 	3P 41830	4P 41831	
	IN125T	fixed FC 	3P 41835	4P 41836	
		fixed RC 	■	■	= IN125T fixed FC + 1 set of rear connections per pole 41190
	IN160T	fixed FC 	3P 42710	4P 42711	
		fixed RC 	■	■	= IN160T fixed FC + 1 set of rear connections per pole 43472
	IN250	fixed FC 	3P 43850	4P 43851	
		fixed RC 	■	■	= IN250 fixed FC + 1 set of rear connections per pole 43800
	IN400	fixed FC 	3P 44850	4P 44851	
		fixed RC 	■	■	= IN400 fixed FC + 1 set of rear connections per pole 44800
	IN630	fixed FC 	3P 45850	4P 45851	
		fixed RC 	■	■	= IN630 fixed FC + 1 set of rear connections per pole 44800
	IN1000	fixed FC 	3P 47775	4P 47751	
	IN1600	fixed FC 	3P 47776	4P 47851	
	IN2500	fixed FC 	3P 47777	4P 47855	

www.ElectricalPartManuals.com

electrical auxiliaries

auxiliary contacts

	1 OF or CAM ⁽¹⁾	
	IN63T to IN160T	41843
	IN250 to IN2500	42906
	2 OF	
	IN400 to IN2500	47757

accessories

direct rotary handle

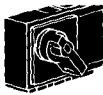
	with black toggle	built-in
	red toggle	
	IN63T	41847
	IN125T/IN160T	41848
	IN250	44847
	IN400/IN630	45859

lateral rotary handle

with black toggle	
IN63T	41826
IN125T/160T	41827
red toggle only	
IN63T	41822
IN125T/160T	41824

accessories for converting direct handle to extended handle

	IN63T to IN160T	41839
	IN250 to IN630	45853
	IN1000 to IN2500	47753
	for lateral rotary handle	
	IN125T/IN160T	41825

locking of the toggle

	by 3 padlocks	built-in
	(1 padlock on IN63T)	
	by key lock (in open and closed position) for IN250 to IN2500	
	1 Ronis key lock 1351.500	41940
	1 Profalux key lock	42888
	K25 B24 D4Z	

door locking for switch in closed position (only for extended rotary handle)

IN63T to IN160T	41840
IN250 to IN2500	47754

mechanical interlocking

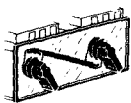

(only for direct rotary handle)		
IN63T to IN160T	41846	
IN250 to IN630	45856	



key lock interlocking for IN250 to IN2500

	1 set of 2 Ronis 1351.500	41950
	key locks (1 single key)	
	1 set of 2 Profalux	42878
	KS5 B24 D4Z key locks	
	(1 single key)	

sealable terminal shields

	short term. shields (1 set)	
	IN250	3P/4P 43830
	IN400/IN630	3P/4P 44830
	long term. shields (1 set)	
	IN63T	3P/4P 41841
	IN125T/IN160T	3P/4P 41842
	IN250	3P/4P 43832
	IN400/IN630	3P/4P 44832

phase separators (1 set)

IN1000/IN1600	3P/4P 47756
---------------	--------------------

connection

Polybloc terminal (for bare cables)

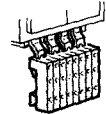
	IN125T/IN160T	
	6 cables $S \leq 10^2$	07100

connectors for bare cables

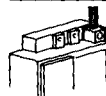
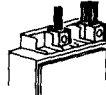
	IN63T	
	$S \leq 35^2$	built-in
	IN125T	
	$16 \leq S \leq 70^2$	per pole 41838
	IN160T	
	$16 \leq S \leq 95^2$	per pole 41838
	IN250T	
	$16^2 \leq S \leq 185^2$	per pole 43813
	extension of rear connections (compulsory when per pole 43848 spacing supports)	
	IN400/IN630	
	single connector	per pole 44813
	(1 cable $S \leq 300^2$)	
	double connector	per pole 44814
	(2 cables $S \leq 240^2$)	

complementary pads for bars

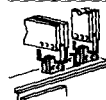
	edgewise pads	
	IN1000	per pole 47758
	IN1600	per pole 47858

spreader

IN400/IN630	3P	44841
	4P	44842

	IN1000 (1 set)	3P	47760
		4P	47761
	IN1600 (1 set)	3P 2 ×	47760
		4P 2 ×	47761

connectors

IN2500	1 piece	55675
--------	---------	--------------

spare parts

black toggle (for direct rotary handle)







	IN63T	41844
	IN125T/IN160T	41845
	IN250	44846
	IN400/IN630	45858
	IN1000/IN1600	47759
	IN2500	47862

switches

Compact load break switches

C101NI to C1251NI

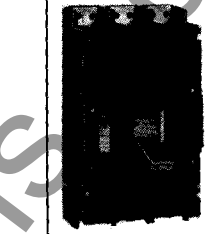
characteristics

									
Compact characteristics									
load break switch		C101NI	C161NI	C225NI	C250NI	C401NI	C630NI	C801NI	C1251NI
rated current	(A) at 40 °C	125	160	225	280	440	700 ⁽³⁾	800	1380
	cl. AC 23 ⁽¹⁾ or DC 23 ⁽¹⁾⁽²⁾ (A) at 60 °C	100	160	200	250	400	630 ⁽³⁾		1250
rated voltage (V)	AC 50/60 Hz	660	660	660	660	660	660 ⁽³⁾	660	660
	DC ⁽²⁾	500	500	500	500	500	500	500	500
number of poles		2, 3, 4	2, 3, 4	3	2, 3, 4	2, 3, 4	3, 4	3, 4	3, 4
short circuit make current (kA peak)		3.5	3.5	3.5	6.5	9	13	20	30
withstand current	kA rms	2.5	2.5	2.5	4.6	6	7.5	10	15
	for(s)	3	3	3	3	3	10	8	8
endurance	mechanical	15000	15000	15000	10000	10000	10000	10000	10000
	electrical at 415 V	5000	5000	5000	3000	1000	1000	1000	1000
degree of protection		with terminal shields: IP40 - In enclosures: IP55							
protection									
by N/H/L Compact circuit-breaker	(ICC max. = breaking capacity of the CB)	C101 C161 C250	C161	C250	C250	C401 C400 ST	C630 C630 ST	C801 C1001 C1251	C1251
by fuses	aM type ⁽⁴⁾ max. (A)	250	250	250	500	500	630	1250	1250
	(Isc max. = 100 kA rms) gI type max. (A)	315	315	315	630	630	800	1600	1600
models									
with adaptable elements	Vigicompact NI ELCB	■	■		■	■	■	(3)	(3)
	autom. source changeover				■	■	■	■	■
	manual source changeover	■	■		■	■	■	■	■
auxiliaries and accessories									
adaptable auxiliaries	auxiliary switch (OF, CAM)	■	■	■	■	■	■	■	■
	alarm switch (SD)	■	■	■	■	■	■	■	■
	voltage release (MX) or (MN)	■	■	■	■	■	■	■	■
	motor mechanism	■	■	■	■	■	■	■	■
adaptable accessories	terminal shields	■	■	■	■	■	■	■	■
	connection accessories	■	■	■	■	■	■	■	■
	padlocking device	■	■	■	■	■	■	■	■
	locking device	■	■	■	■	■	■	■	■
	rotary handle	■	■	■	■	■	■	■	■
installation									
versions	connection	FC	RC	FC	RC	FC	RC	FC	RC
	fixed	■	■	■	■	■	■	■	■
	plug-in	■	■	■	■	■	■	■	■
		same as for Compact CB (see p. 119)							

(1) According to IEC standards, AC 21, AC 22 and AC 23 classes correspond to normal operation with alternating current, and DC 21, DC 22 and DC 23 normal operation with direct current.



www.electricalpartsnr.com

		complete switch...	... consisting of:						
C101NI	fixed FC	<table border="1"> <tr> <td>2P</td> <td>3P</td> <td>4P</td> </tr> <tr> <td>39702</td> <td>39703</td> <td>39704</td> </tr> </table>	2P	3P	4P	39702	39703	39704	
	2P	3P	4P						
	39702	39703	39704						
fixed RC	<table border="1"> <tr> <td>■</td> <td>■</td> <td>■</td> </tr> </table>	■	■	■	= C101 NI fixed FC + 1 set of rear connections(1) per pole 39998				
■	■	■							
plug-in FC RC	<table border="1"> <tr> <td>■</td> <td>■</td> <td>■</td> </tr> </table>	■	■	■	= C101 NI fixed FC + 1 set of plugs per pole 39985 + 1 plug-in base FC/RC 2P 39972 3P 39973 4P 39974 + 1 set of short term. shields 2P/3P 39983 4P 39984				
■	■	■							
C161NI	fixed FC	<table border="1"> <tr> <td>40902</td> <td>40903</td> <td>40904</td> </tr> </table>	40902	40903	40904				
	40902	40903	40904						
	fixed RC	<table border="1"> <tr> <td>■</td> <td>■</td> <td>■</td> </tr> </table>	■	■	■	= C161 NI fixed FC + 1 set of rear connections per pole 41190			
■	■	■							
plug-in FC RC	<table border="1"> <tr> <td>■</td> <td>■</td> <td>■</td> </tr> </table>	■	■	■	= C161 NI fixed FC + 1 set of plugs per pole 41194 + 1 plug-in base FC/RC 2P 41195 3P 41196 4P 41197 + 1 set of short term. shields 2P/3P 42960 4P 42961				
■	■	■							
C225NI	fixed FC	<table border="1"> <tr> <td>2P</td> <td>3P</td> <td>4P</td> </tr> <tr> <td colspan="3">43676</td> </tr> </table>	2P	3P	4P	43676			
	2P	3P	4P						
43676									
fixed RC	<table border="1"> <tr> <td>■</td> <td></td> <td></td> </tr> </table>	■			= C225NI fixed FC + 1 set of rear connection per pole 43472				
■									
C250NI	fixed FC	<table border="1"> <tr> <td>43325</td> <td>43326</td> <td>43327</td> </tr> </table>	43325	43326	43327	= C250NI without release, fixed FC 2P 43001 3P 43002 4P 43003 + 1 switch module 2P/3P 43323 4P 43324			
	43325	43326	43327						
	fixed RC	<table border="1"> <tr> <td>■</td> <td>■</td> <td>■</td> </tr> </table>	■	■	■	= C250NI fixed FC + 1 set of rear connections per pole 43800			
■	■	■							
plug-in FC RC	<table border="1"> <tr> <td>■</td> <td>■</td> <td>■</td> </tr> </table>	■	■	■	= C250NI fixed FC + 1 set of plugs per pole 43802 + 1 plug-in base FC/RC 2P 43809 3P 43810 4P 43811 + 1 set of short term. shields 2P/3P 43829 4P 43830				
■	■	■							
C401NI	fixed RC	<table border="1"> <tr> <td>44792</td> <td>44793</td> <td></td> </tr> </table>	44792	44793		= C401NI without release, fixed FC 3P 44661 4P 44662 + 1 switch module 3P 45375 4P 45376			
	44792	44793							
	fixed RC	<table border="1"> <tr> <td>■</td> <td>■</td> <td></td> </tr> </table>	■	■		= C401NI fixed FC + 1 set of rear connections per pole 44800			
■	■								
plug-in FC RC	<table border="1"> <tr> <td>■</td> <td>■</td> <td></td> </tr> </table>	■	■		= C401NI fixed FC + 1 set of plugs(1) per pole 44802 + 1 plug-in base FC/RC 3P 44810 4P 44811 + 1 set of short term. shields 3P 44829 4P 44830				
■	■								
C630NI	fixed FC	<table border="1"> <tr> <td>45379</td> <td>45380</td> <td></td> </tr> </table>	45379	45380		= C630NI without release, fixed FC 3P 45002 4P 45003 + 1 switch module 3P 45375 4P 45376			
	45379	45380							
	fixed RC	<table border="1"> <tr> <td>■</td> <td>■</td> <td></td> </tr> </table>	■	■		= C630NI fixed FC + 1 set of rear connections per pole 44800			
■	■								
plug-in FC RC	<table border="1"> <tr> <td>■</td> <td>■</td> <td></td> </tr> </table>	■	■		= C630NI fixed FC + 1 set of plugs per pole 44802 + 1 plug-in base FC/RC 3P 44810 4P 44811 + 1 set of short term. shields 3P 44829 4P 44830				
■	■								
C801NI C1251NI	fixed FC	<table border="1"> <tr> <td>C801NI</td> <td>46045</td> <td>46046</td> </tr> <tr> <td>C1251NI</td> <td>48048</td> <td>48049</td> </tr> </table>	C801NI	46045	46046	C1251NI	48048	48049	
	C801NI	46045	46046						
	C1251NI	48048	48049						
fixed RC	<table border="1"> <tr> <td>■</td> <td>■</td> <td></td> </tr> </table>	■	■		= C801NI or C1251NI fixed FC + 1 rear connections 1 piece 46958				
■	■								
drawout RC(2)	<table border="1"> <tr> <td>■</td> <td>■</td> <td></td> </tr> </table>	■	■		= C801NI or C1251NI + moving chassis 3P 46824 4P 46825 + fixed chassis 3P 46822 4P 46823 + pads flat 1 piece 46990 or edgewise 1 piece 46988 + 1 set of plugs per pole 46915 + 1 set of short terminal shields 3 P 46993 4P 46992				
■	■								

www.electricalpartsnr.com

switches

Fupact fuse-switches UC50 to UD630T

description,
characteristics

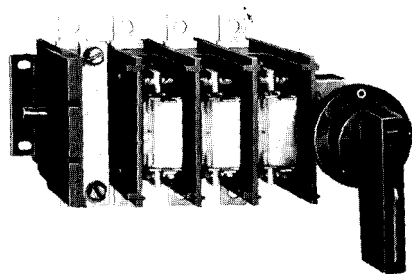

application

The Fupact fuse-switches are designed for:

- control, protection and isolation in the switching of highly inductive loads (transformers, capacitors...);
- the protection and isolation of motor control circuits. They are used in all AC and DC circuits at voltages up to 660 V.

Operation

The Fupact switching technology offers optimum safety:

- Fupact fuse switches, unlike fuse-disconnectors, are suitable for ON-LOAD operation.
- the Fupact's are fixed-mounted and isolation is provided on both the line and the load sides of the fuses. The fuses are therefore isolated when the switch is open.

Positive contact indication

Then handle can only indicate the OFF position if all the contacts are actually open. With its guaranteed contact separation, the Fupact affords maximum safety.

models

The Fupact range includes:

- 2 models for cylindrical fuses (UC50 and UC125),
 - 6 models from 63 to 630 A for fuses of DIN type (UD63-UD125-UD160-UD250T-UD400T-UD630T).
- Number of poles:
- 3 poles with 3 fuses;
 - 4 poles with 3 fuses, neutral broken and unprotected (link provided);
 - 4 poles with 4 fuses (except UD63).

standards

Fupact fuse-switches comply with international IEC standard 408, British Standard BS 5419, German standard VDE 0660, VDE 0113, Det Norske Veritas, AS 1775-1975, UL 512.

approvals

UL and ASTA certified (UD 160 to 400 pending) Lloyd's Register of Shipping, Germanische Lloyd's, Register of Shipping of the USSR.

tropicalization

All climates (treatment 2).

characteristics (IEC 408)

Fupact fuse-switch		UC50	UD63	UC125	UD125	UD160	UD250T	UD400T	UD630T	
fuse size		14 × 51	DIN 00	22 × 58	DIN 00	DIN 00 ⁽¹⁾	DIN 1	DIN 2	DIN 3	
rated current AC 22 (A) vertical installation	without stricker	40 °C	50	63	125	125	160	250	400	630
		60 °C	40	50	100	100	128	200	320	504
	with stricker	40 °C	37	47	94	94	120	188	296	472
		60 °C	28	38	75	75	96	150	224	378
horizontal installation	without stricker	40 °C	45	57	112	112	144	224	360	567
		60 °C	36	45	90	90	115	180	288	454
	with stricker	40 °C	34	42	78	78	108	156	272	425
		60 °C	27	34	67	67	86	134	216	340
rated current AC 23 (A)	380-415-440-500 V	50	63	115	115	125	250	400	630	
	660 V	45	40	63	63	63	250	400	630	
rated voltage (V) AC 50/60 Hz ⁽⁴⁾		660	660	660	660	660	660	660	660	
rated isolation voltage (V)		750	750	750	750	750	750	750	750	
rated fuses short-circuit capacity at 500 V (kA)		50	50	100	100	100 ⁽²⁾	100	100	80	
breaking capacity AC 23 (A)	380-415-440-500 V	500	500	800	800	800	3200	3200	4500	
	660 V	350	350	500	500	500	3200	3200	4500	
breaking capacity DC (A) L/R ≤ 15 ms	110 V (2 poles in series)	300	300	500	500	500	1600	1600	3200	
	200 V (2 poles in series)	250	250	400	400	400	1200	1600	2000	
operational power AC 23 (kW)	380 V	22	30	55	55	60	130	210	315	
	415 V	30	30	60	60	65	140	230	340	
	500 V	30	30	75	75	80	170	280	400	
	660 V	30	30	55	55	55	230	330	540	
mechanical endurance (CO)		10000	10000	7500	7500	7500	5000	5000	3000	
weight without fuse (kg)	3P 3 fuses	1.6	1.6	1.8	1.8	1.8	6.9	7.8	15.5	
	4P 4 fuses	1.9	1.9	2.3	2.3	2.3	7.9	8.8	19	
auxiliary switches breaking capacity thermal rating		4 A at 415 V AC11; 1 A at 115 V DC11 10 A								

part numbers

Fupact with standard handle and short shaft (without fuses)	Fupact type	3P 3 fuses	4P 3 fuses ⁽¹⁾	4P 4 fuses
	UC50	49001	49002	49003
	UD63	49004	49005	—
	UC125	49006	49007	49008
	UD125	49009	49010	49011
	UD160	49012	49013	49014
	UD250T	49210	49211	49212
	UD400T	49216	49217	49218
	UD630T	49219	49220	49221

accessories et auxiliaries

	P 3 fuses	4P 3 fuses ⁽¹⁾	4P 4 fuses	
fuse cover (compulsory when the fuse-switch is mounted without door escutcheon)	UC50	49024	49025	49025
	UD63	49026	49027	—
	UC125-UD125-UD160	49028	49029	49029
	UD250T	49237	49237	49247
	UD400T	49216	49238	49248
	UD630T	49250	49251	49251
blown fuse indicating device for fuse with striker	UD50	49057	49058	49058
	UC125	49059	49060	49060
	UD250T	49080	49081	49082
	UD400T	49083	49084	49085
	UD630T	49086	49087	49088
terminal shields (for one side)	UC125-UD125-UD160	49034	49035	49035
	UD250T (per pole. 49257)	3 × 49250	4 × 49255	4 × 49255
	UD400T (per pole. 49257)	3 × 49257	4 × 49257	4 × 49257
	UD630T (per pole. 49257)	3 × 49257	4 × 9257	4 × 49257
auxiliary switches	UC50-UD63		1 OF 49056	2 OF 49040
	UC125-UD125-UD160		1 OF 49041	2 OF 49042
	UD250T-UD400T-UD630T		1 OF 49089	2 OF 49090
auxiliary switch cover	UC50-UD63			49045
	UC125-UD125-UD160			49046
	UD250T-UD400T-UD630T		included with OF contacts	
long shaft for extended rotary handle	UC50-UD63-UC125			49048
	UD125-UD160			
	UD250T-UD400T-UD630T			49245
neutral link and its support	UD50-UD63			49273
	UC125-UD125-UD160			49274
	UD250T-UD400T			49275
	UD630T			49276
locking device (key lock not supplied)	UD250T-UD400T-UD630T			49053
black toggle	UC50-UD63-UC125			49054
	UD125-UD160			
	UD250T-UD400T-UD630T			49055

individual enclosures weatherproof metal enclosures

description, characteristics
part numbers
dimensions

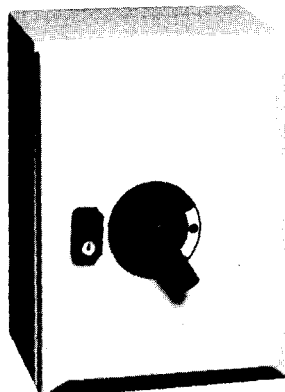

description

Weatherproof metal enclosures are available for the following circuit breakers:

- Compact and Vigicompact C101N to C1251N as well as their variations, all types of trip unit, in fixed front connected version;

- Interpact IN63T to IN630.

The weatherproof metal enclosures include:

- a plate equipped for the mounting of fixed front connected, two, three or four pole circuit-breakers;
- a door cutout for the fixing of the rotary handle.

characteristics

Degree of protection: IP 55.

1.5 mm thick electro-zinc coated steel sheet.

Beige epoxy powder painting.

Cable entry through removable bottom plate.

Secured by 4 holes on the back or by external fixing lugs (supplied).

control and locking

Compact C101N to C630N ST

Vigicompact C101N to C630N ST

- direct rotary handle actuated through the door, with watertight escutcheon;

- locking of the breaker in "OFF" position by 3 padlocks (not supplied).

Available on request:

- locking of the breaker in "OFF" position with a Ronis lock 1351.500 or a Profalux lock KS5 B24 D4Z.

Compact C801 to C1251N

- waterproof extended rotary handle;

- locking of the breaker in "OFF" position by 3 padlocks (not supplied).

- locking of the door when the breaker is in "ON" position.

Interpact IN63T to IN630

- extended rotary handle;

- locking of the switch in "OFF" position by 3 padlocks, not supplied (only one padlock for IN63T).

Available on request:

- locking of the switch in "OFF" position with a Ronis lock 1351.500 or a Profalux lock KS5 B24 D4Z (except IN63T, IN125T, IN160T).

- locking of the door when the switch is in "ON" position.

part numbers

metal enclosures		including:					
for Compact C101N to C630N	for Compact	C101N	C161N	C250N	C401N	C630N	<ul style="list-style-type: none"> ■ empty enclosure with plate and drilled door, ■ 1 direct rotary handle, ■ 1 watertight escutcheon for rotary handle, (to complete with Compact 2P, 3P, 4P, fixed FC)
		39960	41932	43990	44990	45990	
for Vigicompact C101N to C630N	for Vigicompact	C101N	C161N	C250N	C401N	C630N	<ul style="list-style-type: none"> ■ empty enclosure with plate and drilled door, ■ 1 direct rotary handle, ■ 1 watertight escutcheon for rotary handle, (to complete with Vigicompact 3P, 4P, fixed FC)
		39959	41933	43991	44991	44991	
for Compact C801 to C1251N	for Compact	C801N	C1001N	C1251N			<ul style="list-style-type: none"> ■ empty enclosure with plate and drilled door, ■ 1 extended rotary handle (front door mounted), ■ accessories for watertight rotary handle, (to complete with Compact 3P, 4P, fixed FC)
		46888	46888	46888			
for Interpact IN63T to IN630	for Interpact	IN63T	IN125T	IN250	IN630		<ul style="list-style-type: none"> ■ empty enclosure with plate and drilled door, ■ accessories for converting direct to extended rotary handle (to complete with Interpact 3P, 4P, fixed FC)
		41853	41856	43843	44941		
for Fupact	consult us						

accessories

locks for rotary handle,
switch in "OFF" position

by 3 padlocks (1 padlock for IN63T), padlock not included

built-in

by keylocks for C101N to C1251
and Interpact IN250 to IN400

1 Ronis key lock 1351.500 **41940**

1 Profalux key lock KS5 B24 D4Z **42888**

Interpact IN63T to IN160T **41840**

Interpact IN250 to IN630 **45854**

dimensions (mm)

	direct rotary handle				extended rotary handle					
	Compact			Vigicompact	Compact		Interpact			
	C101N	C250N	C630N	C101N	C250N	C801N	C1001N	IN63T	IN125T	IN250
	C161N	C401N		C161N	to C630N		C1251N		IN160T	to IN630
H	400	600	800	500	800	1000	1000	400	400	600
W	300	400	600	400	600	600	600	300	300	400
D	200	200	275	200	275	275	275	150	150	200

individual enclosures weatherproof polyester enclosures

description, characteristics
part numbers
dimensions

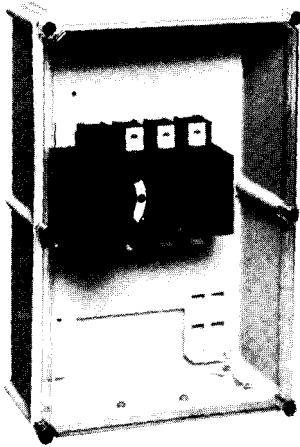

description

Weatherproof polyester enclosures are available for the following circuit breakers:

- Compact and Vigicompact C101N to C1251N as well as their variations, all types of trip unit, in fixed front connected version;

- Intercompact IN63T to IN630.

The weatherproof metal enclosures include:

- a plate equipped for the mounting of fixed front connected, two, three or four pole circuit-breaker;
- a door cutout for the fixing of the rotary handle.

characteristics

Degree of protection: IP 55.

Beige polyester.

Shockproof and corrosionproof.

The screwed transparent cover can be fitted with lead seals.

Cable entry through removable bottom and top plates.

Secured by 4 holes on the back.

control and locking

Compact C101N to C630N

Vigicompact C101N to C630N ST

- extended rotary handle;
- locking of the breaker in "OFF" position by 3 padlocks (not supplied).
- locking of the cover when the breaker is in "ON" position.

Available on request:

- locking of the breaker in "OFF" position with a Ronis lock 1351.500 or a Profalux lock KS5 B24 D4Z.

Intercompact IN63T to IN630

- extended rotary handle;
- locking of the switch in "OFF" position by 3 padlocks not supplied (only one padlock for IN63T).

Available on request:

- locking of the switch in "OFF" position with a Ronis lock 1351.500, or a profalux lock KS5 B24 D4Z (except IN63T, IN125T, IN160T).

- locking of the cover when the switch is in "ON" position.

part numbers

polyester enclosures						including:
for Compact C101N to C630N	C101N	C161N	C250N	C401N	C630N	<ul style="list-style-type: none"> ■ empty enclosure with plate and drilled door, ■ 1 direct rotary handle, ■ 1 watertight escutcheon for rotary handle, (to complete with Compact 2P, 3P, 4P, fixed FC)
	39958	41936	43995	44995	44995	
for Vigicompact C101N to C630N	C101N	C161N	C250N	C401N	C630N	<ul style="list-style-type: none"> ■ empty enclosure with plate and drilled door, ■ 1 direct rotary handle, ■ 1 watertight escutcheon for rotary handle, (to complete with Vigicompact 3P, 4P, fixed FC)
	39957	41937	43996	44996	44996	
for intercompact IN63T to IN400	IN63T	IN125T	IN250	IN400		<ul style="list-style-type: none"> ■ empty enclosure with plate and drilled door, ■ accessories for converting direct to extended rotary handle, (to complete with inter[act 3P, 4P, fixed FC)
	IN161T			IN630		
	41858	41859	43844	44942		

accessories

locks for rotary handle, switch in "OFF" position	by 3 padlocks (1 padlock for IN63T), padlocks not included	built-in
	by keylocks for C101N to C630N, and Intercompact IN250 to IN400	1 Ronis key lock 1351.500 41940 1 Profalux key lock KS5 B24 D4Z 42888
door locking, switch in closed position	Intercompact IN63T to IN60T	41840
	Intercompact IN250 to IN630	45854

dimensions (mm)

extended rotary handle

	Compact			Vigicompact		Intercompact	IN125T IN160T	IN250	IN400 IN630
	C101N C161N	C250N	C401N C630N	C101N C161N	C250N to 630N	IN63T			
H	360	540	720	540	720	270	360	540	720
W	270	270	360	270	360	270	270	360	360
D	235	235	235	235	235	185	185	185	185

www.ElectricalPartManuals.com

Compact Interpact

5 dimensions tripping curves

	page
C100E to C600E	120
C100NF, TC140	121
C101N/H/L/NI	122
C161N/H/L/NI	124
C250N/H/L/NI	126
C401/C630N/H/L/NI	128
C400/C630N/H/L ST	
C801/C1001/C1251N/H/L/NIST	130
chassis for withdrawable CB	132
rotary handles	133
remote control	134
changeover C101N/H/L to C1251N/HST	136
Interpact IN63T to IN2500	138
Fupact UC50 to UD630T	141
tripping curves	142

www.ElectricalPartMarts.com

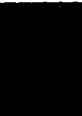

dimensions C100E/C225E/C400E/C600E

Compact C100E

Fixed equipment

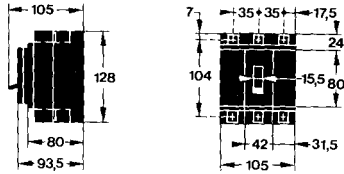

Front connected
panel or rail-mounted

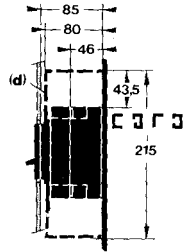

Drilling diagrams

panel-mounted
front or rear connected

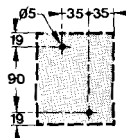

3-pole

rail-mounted
front connected

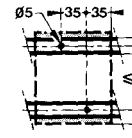

3-pole

Drilling of the door

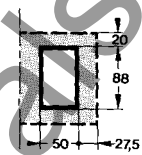

Compact C225E

Fixed equipment

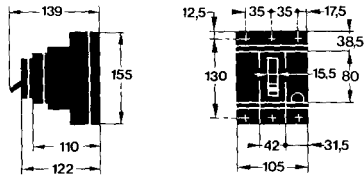

Front or rear
connected
panel or rail-mounted

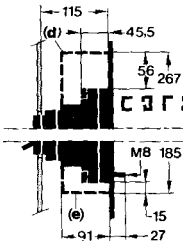

Drilling diagrams

panel-mounted
front or rear connected

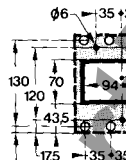

3-pole

rail-mounted
front connected

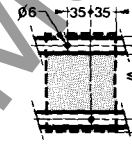

3-pole

Drilling of the door

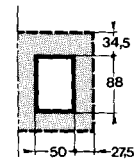

Compact C400E/C600E

Fixed equipment

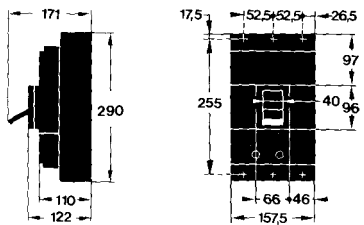

Front or rear
connected
panel or rail-mounted

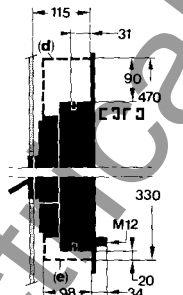

Drilling diagrams

panel-mounted
front or rear connected

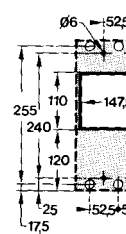

3-pole

rail-mounted
front connected

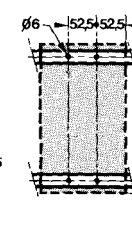

3-Pole

Drilling of the door

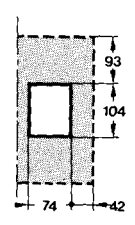

Weights (kg)

type	No. of pole	fixed
C100E	3	1.3

dimensions C100NF/TC40N/L

Compact C100NF

Fixed equipment

Front connected
panel or rail-mounted

Drilling diagrams
panel or rail-mounted
front connected

Drilling of the door

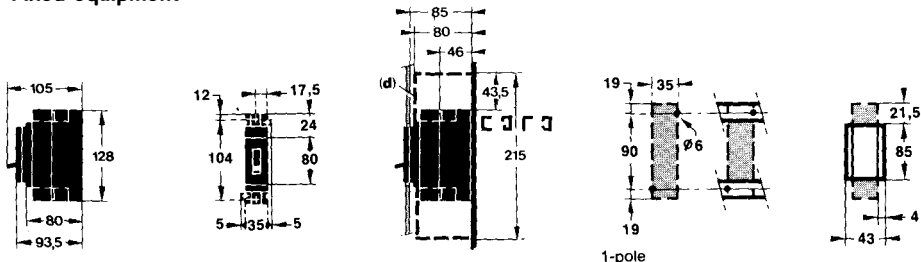

Compact TC40N

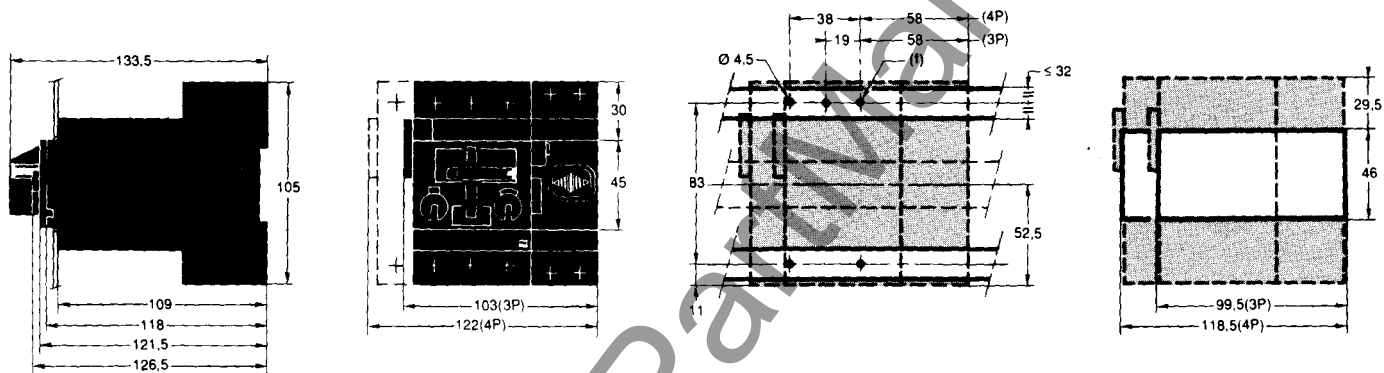

Compact TC40N

+ auxiliary O/F + auxiliary SD/SDM + undervoltage release MN

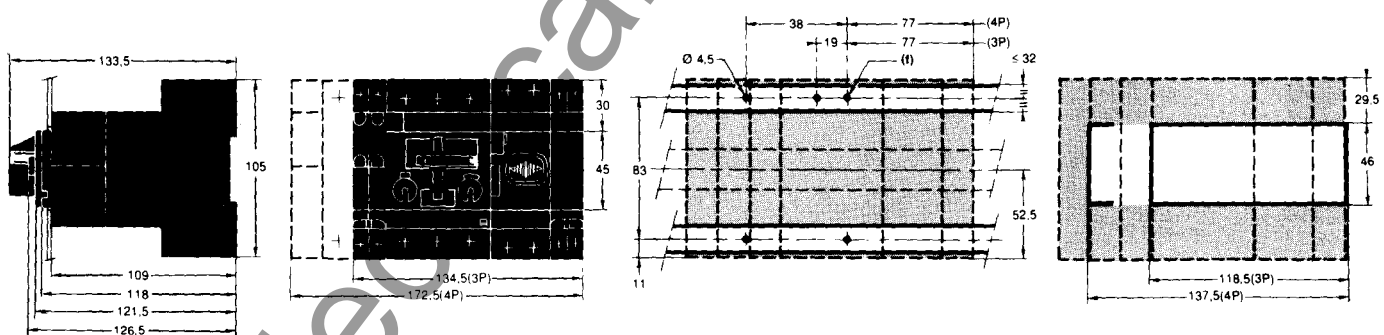

Compact TC40L, Vigicompact TC40N

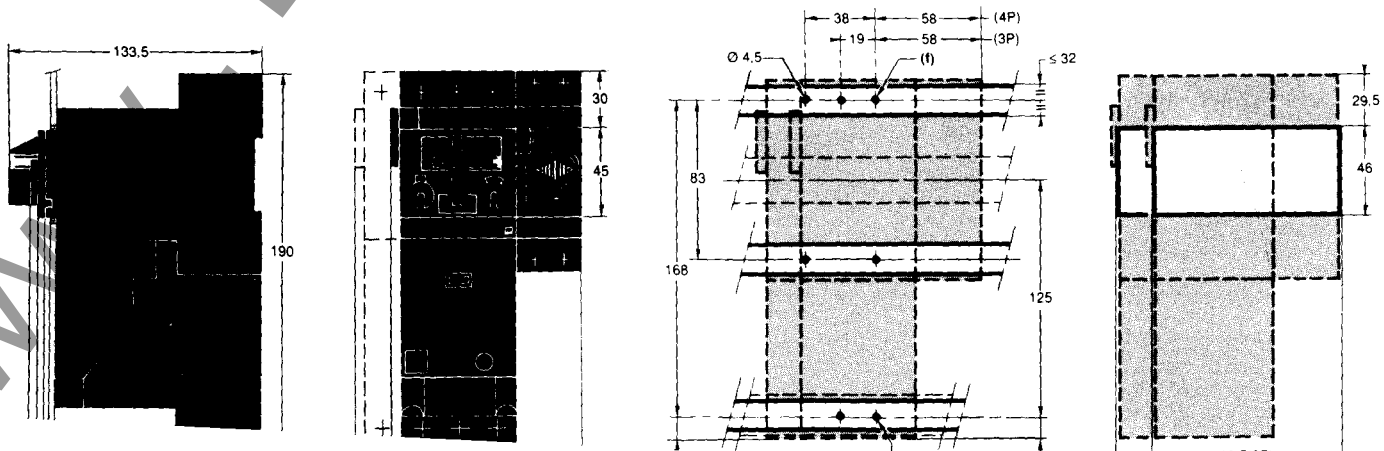

dimensions C101N/H/L

Compact C101N/H, C101NI

Fixed equipment

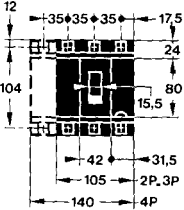
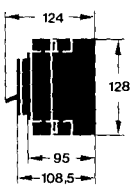

Front or rear connected panel or rail-mounted

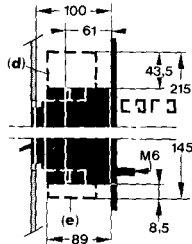

Drilling diagrams panel-mounted front or rear connected

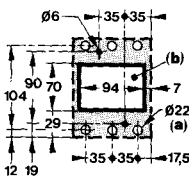

2 or 3-pole

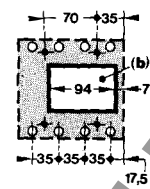

4-pole

rail-mounted front connected

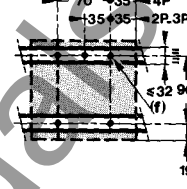

2, 3 or 4-pole

Drilling of the door

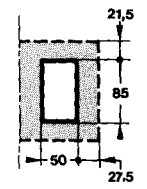

Plug-in equipment

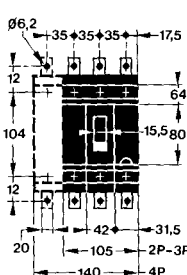
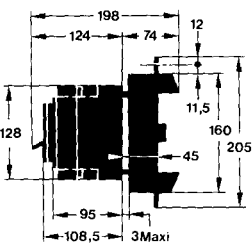

Front or rear connected panel or rail-mounted

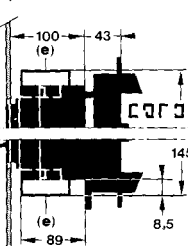

Drilling diagrams panel-mounted front or rear connected

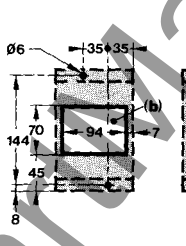

2 or 3-pole

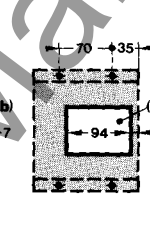

4-pole

rail-mounted front connected

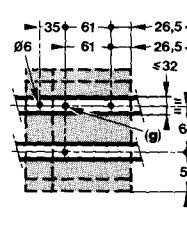

2, 3 or 4-pole

Drilling of the door

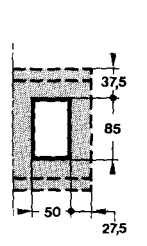

Compact C101L

Fixed equipment

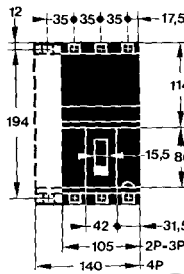
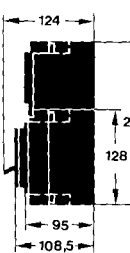

Front or rear connected panel or rail-mounted

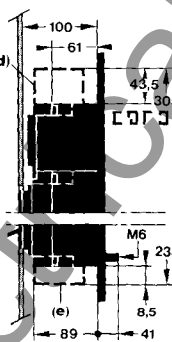

Drilling diagrams panel-mounted front or rear connected

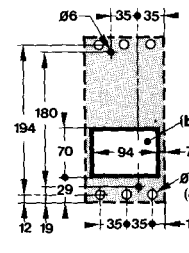

3-pole

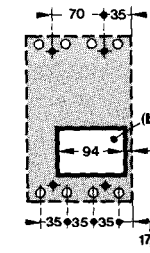

4-pole

rail-mounted front or rear connected

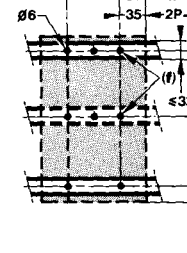

3 or 4-pole

Drilling of the door

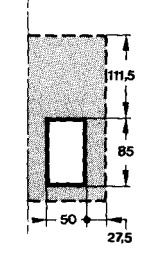

Plug-in equipment

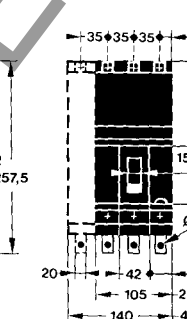
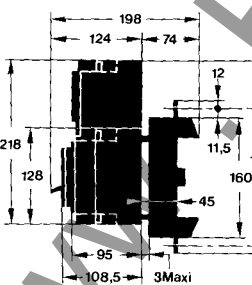

Front or rear connected panel or rail-mounted

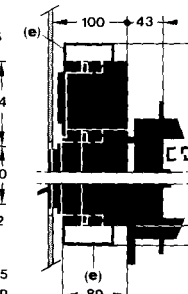

Drilling diagrams panel-mounted front or rear connected

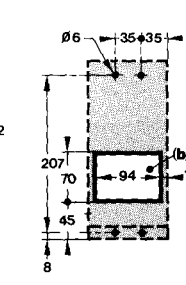

3-pole

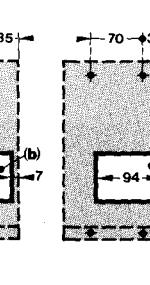

4-pole

rail-mounted front or rear connected

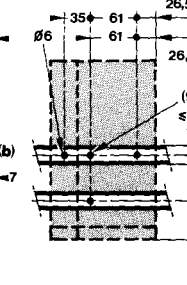

3 or 4-pole

Drilling of the door

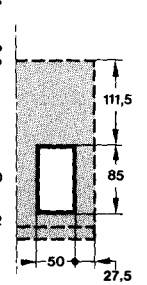

Weight (kg)

type	No of poles	fixed	plug-in with base
C101N/H, C101NI	2	1,5	2,2
	3	1,6	2,4

(a) For rear connection only
(b) Necessary with auxiliary wiring block

Vigicompact C101N/H

Fixed equipment

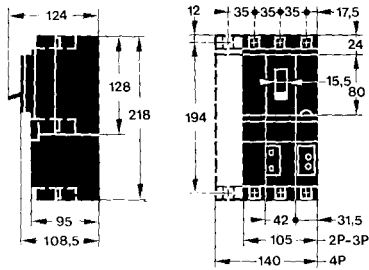

Front or rear connected
panel or rail-mounted

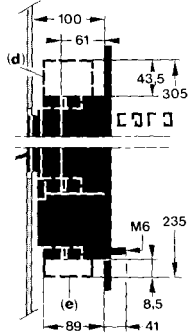

Drilling diagrams
panel-mounted
front or rear connected

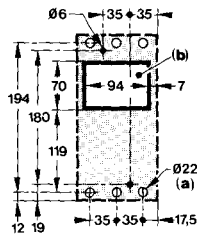

3-pole

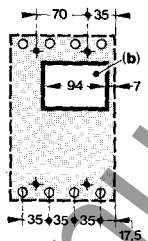

4-pole

rail-mounted
front connected

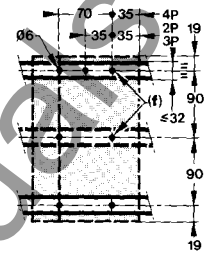

2, 3 or 4-pole

Drilling of
the door

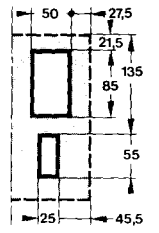

Plug-in equipment

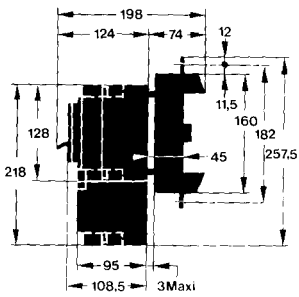

Front or rear connected
panel or rail-mounted

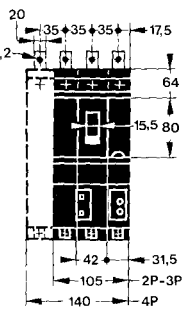

Drilling diagrams
panel-mounted
front or rear connected

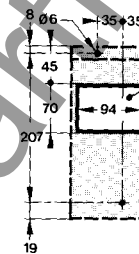

3-pole

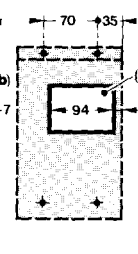

4-pole

rail-mounted
front or rear connected

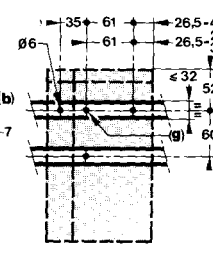

3 or 4 pole

Drilling of
the door

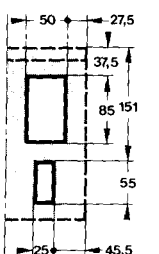

(a) For rear connection only
(b) Necessary with auxiliary wire blocks only
(c) Long terminal shields for front connection

dimensions C161N/H/L

Compact C161N/H/L, C161NI

Compact C161N/H, C161NI

Fixed equipment

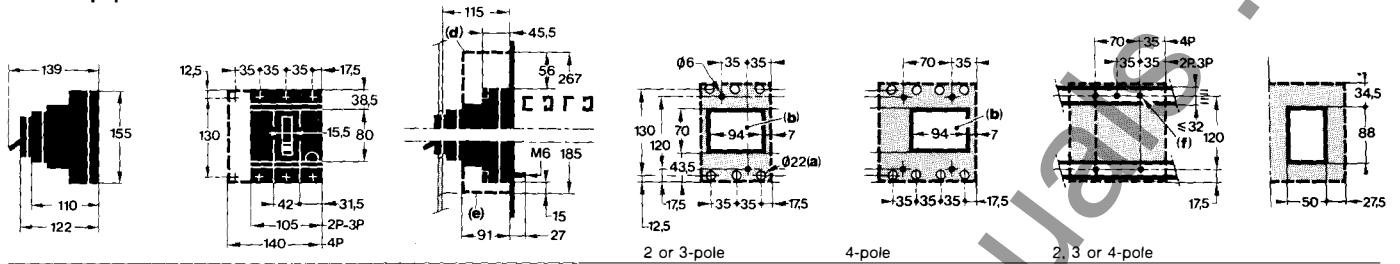

Plug-in equipment

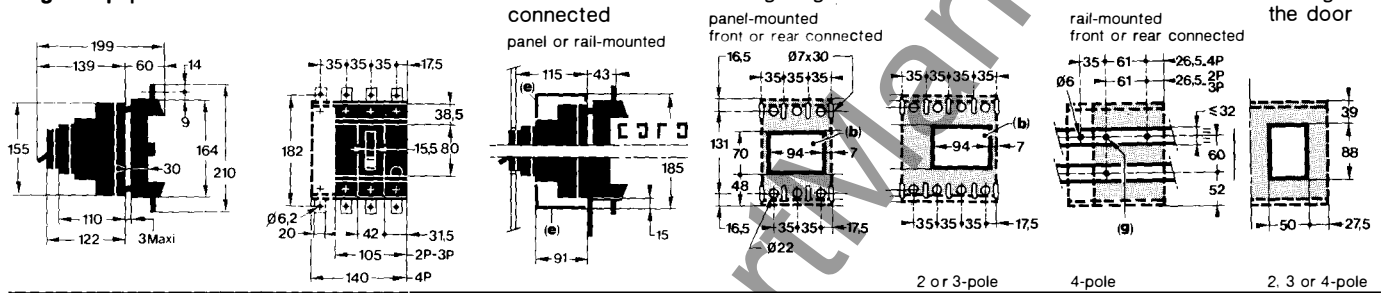

Compact C161L

Fixed equipment

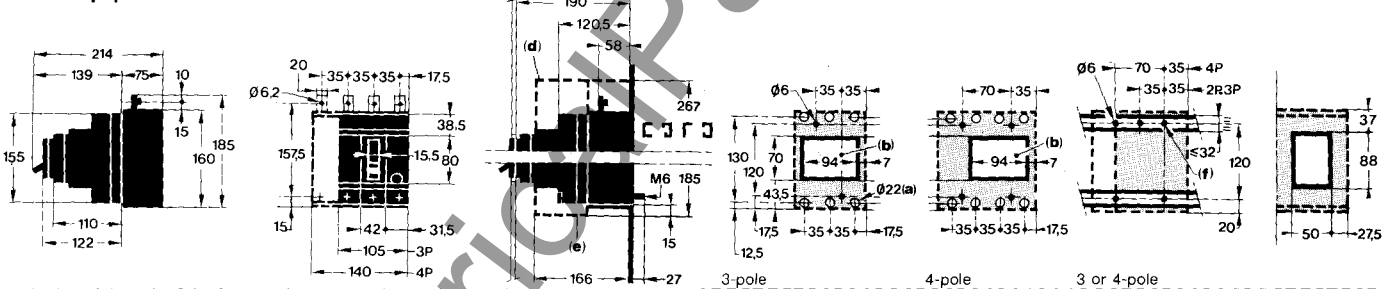

Plug-in equipment

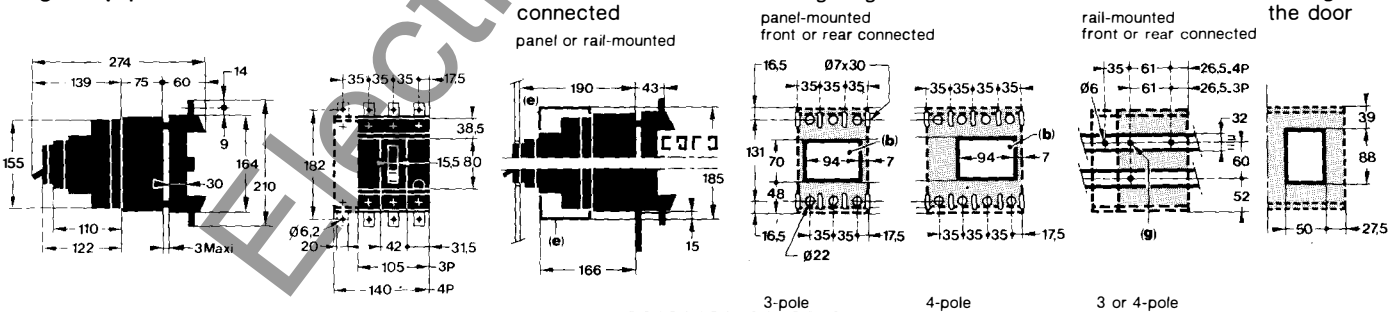

Weight (kg)

type	No of poles	fixed	plug-in with base
C161N/H, C161NI	2	1.5	2.2

(a) For rear connection only
(b) Necessary with auxiliary supply

Vigicompact C161N/H Visucompact and earth leakage Visucompact C161N

Vigicompact C161N/H

Fixed equipment

Front or rear
connected
panel or rail-mounted

Drilling diagrams
panel-mounted
front or rear connected

rail-mounted
front connected

Drilling of
the door

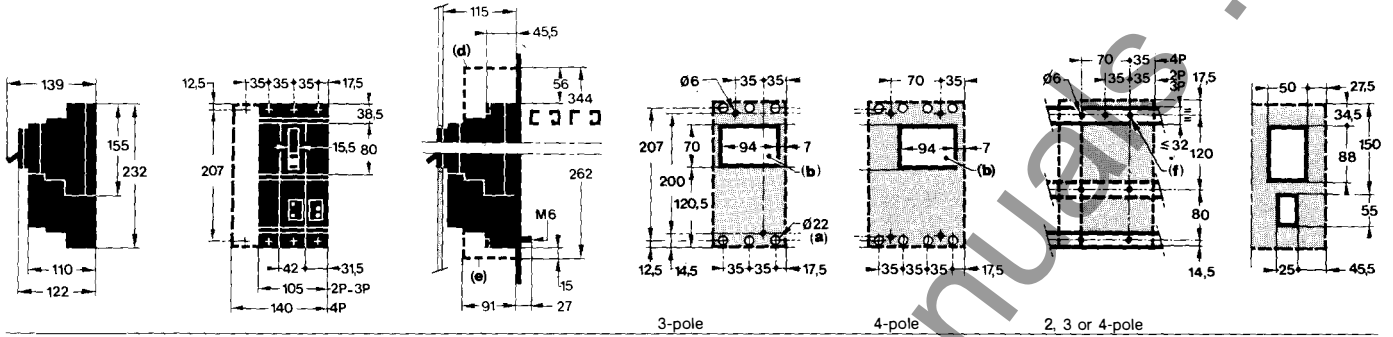

Plug-in equipment

Front or rear
connected
panel or rail-mounted

Drilling diagrams
panel-mounted
front or rear connected

rail-mounted
front or rear connected

Drilling of
the door

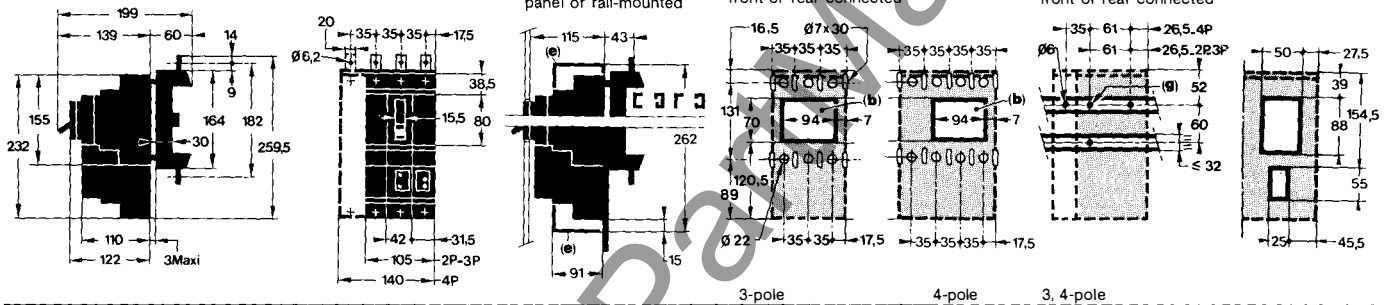

Visucompact C161N

Fixed equipment

Front or rear
connected
panel or rail-mounted

Drilling diagrams
panel-mounted
front or rear connected

rail-mounted
front connected

Drilling of
the door

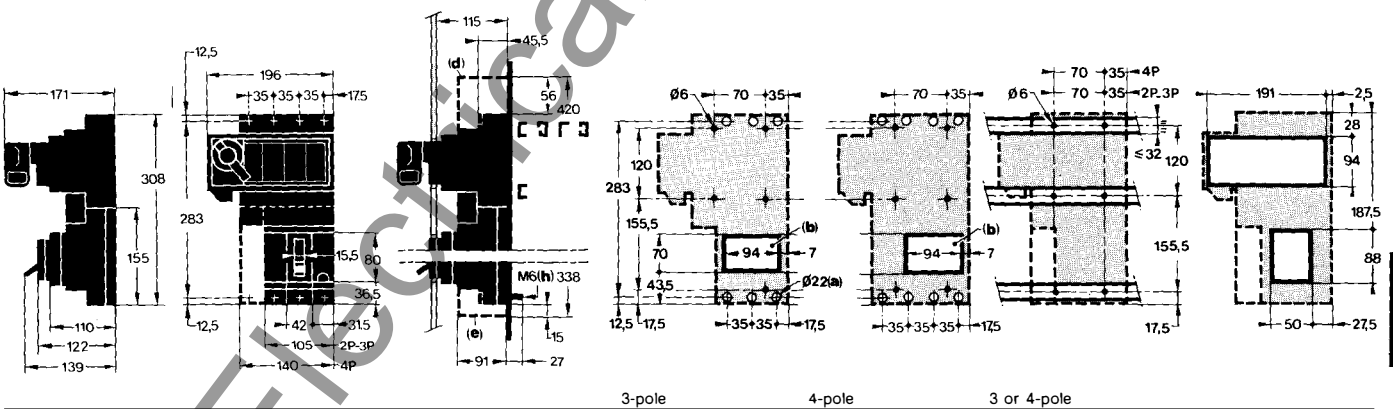

earth leakage Visucompact C161N

The size of the earth leakage Visucompact is identical to the one of the Visucompact (see above), except that the height is 80 mm greater.

Thus:
 ■ the height dimension changes from 308 to 388,
 ■ the lower mounting holes should be repeated 80 mm lower.

Weight (kg)

type	No of poles	fixed	plug-in with base
Vigicompact C161N	3	2,3	3,4
Visucompact C161N	4	3,1	4,6
earth leakage Visucompact C161N	3	3,7	-

(a) For rear connection only
 (b) Necessary with auxiliary wire blocks only
 (d) Long terminal shields for front connection

Vigicompact C250N/H

Fixed equipment

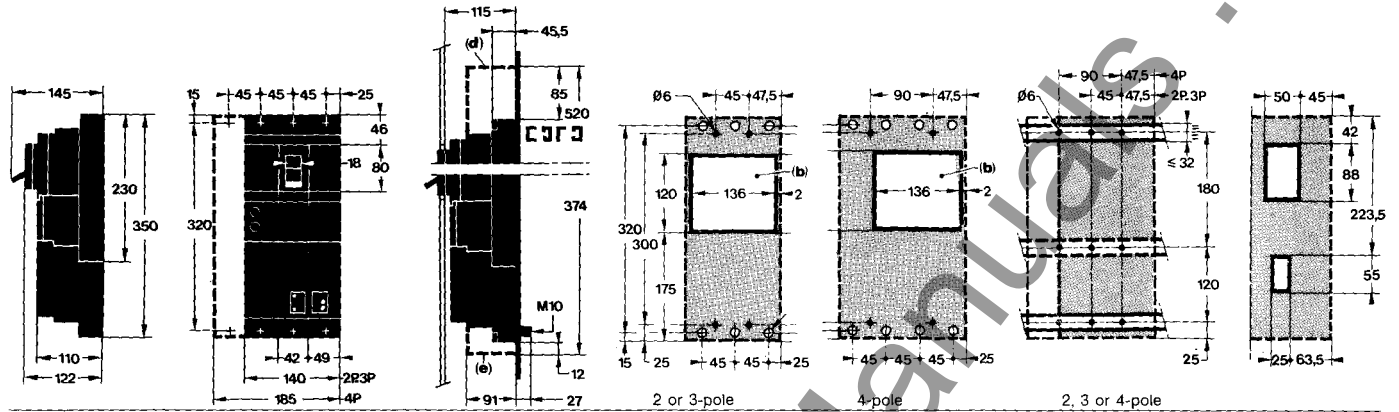

Plug-in equipment

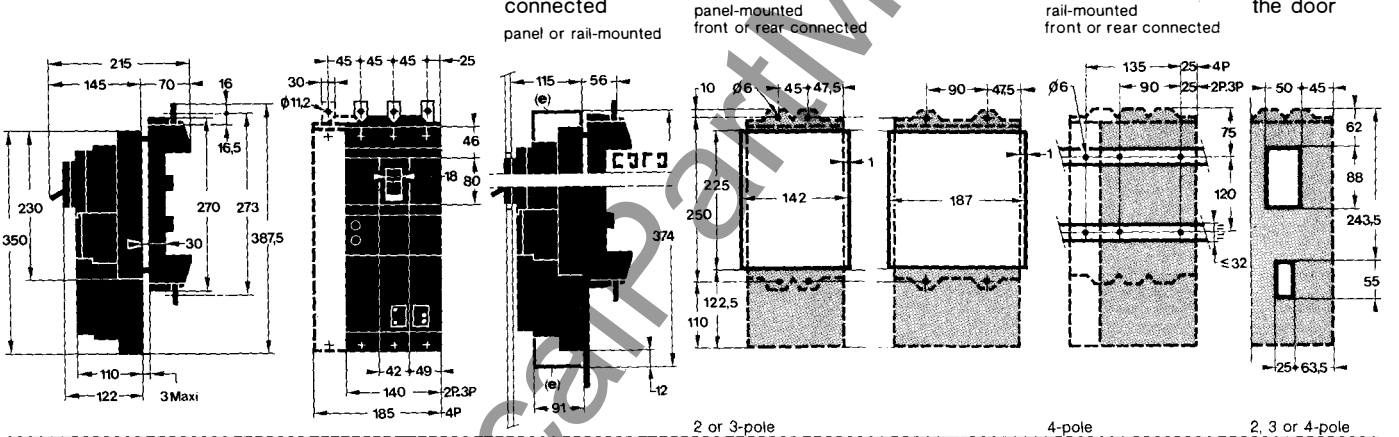

Visucompact C250N

Fixed equipment

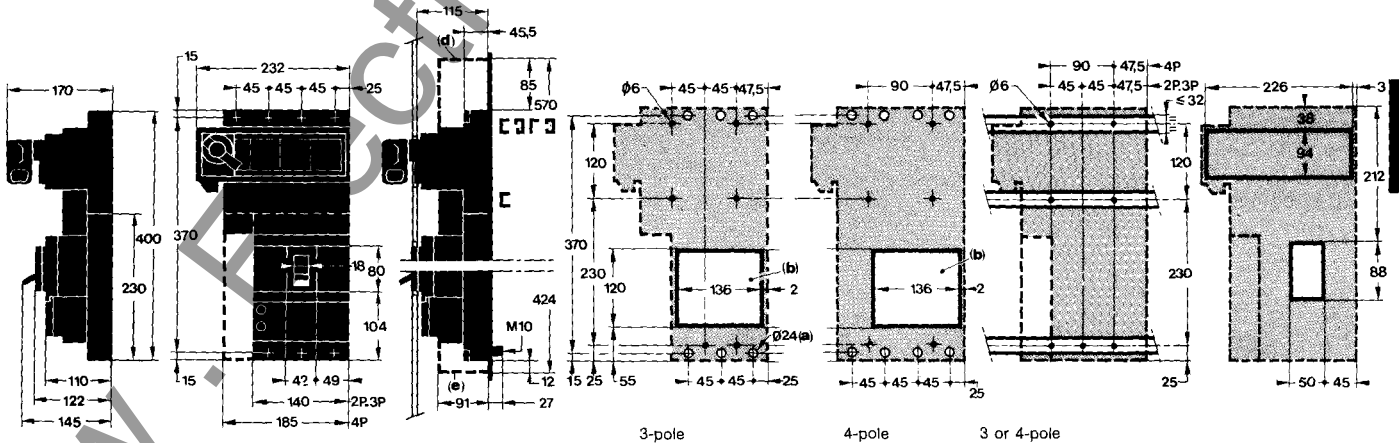

earth leakage Visucompact C250N

The size of the earth leakage Visucompact is identical to the one of the Visucompact (see above), except that the height is 120 mm greater.

Thus:

- the height dimension changes from 400 to 520,
- the lower mounting holes should be repeated 120 mm lower.

Weight (kg)

type	No of poles	fixed	plug-in with base
Vigicompact C250N/H	3	5.2	7.1
	4	6.2	8.6
	3	6.6	

dimensions C401N/H/L, C400N/H/L ST C630N/H/L, C630N/H/L ST

Compact C401/C630N/H/L, C400/C630N/H/L ST, C401/C630NI

Compact C401/C630N/H, C400/C630N/H ST, C401/C630NI

Fixed equipment

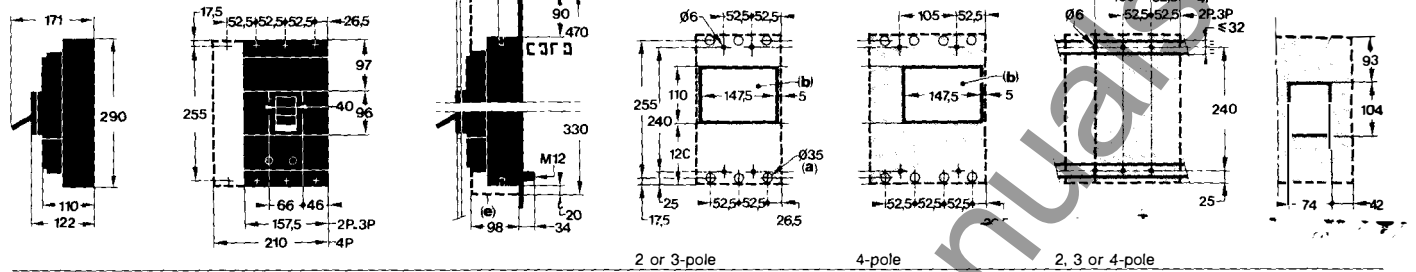

Plug-in equipment

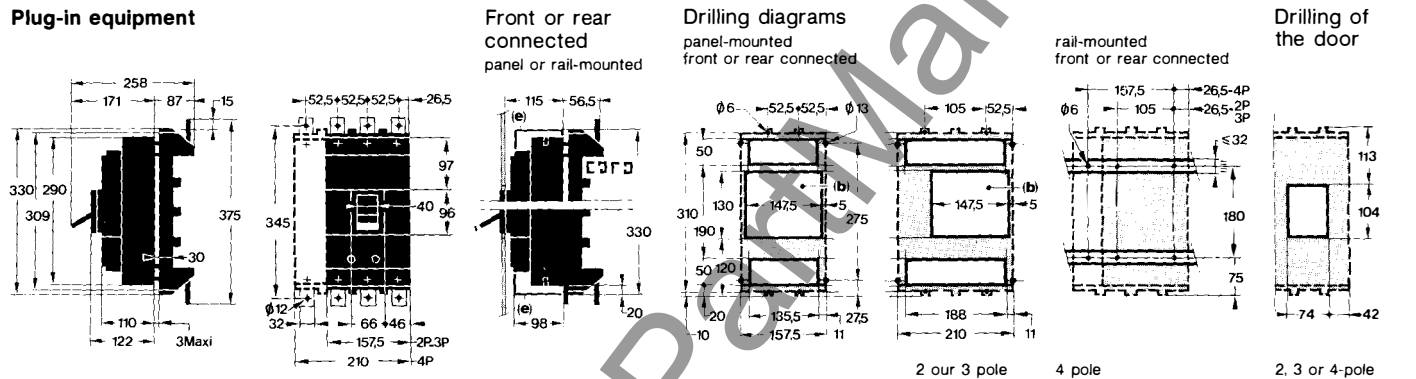

Compact C401/C630L, C400/C630L ST

Fixed equipment

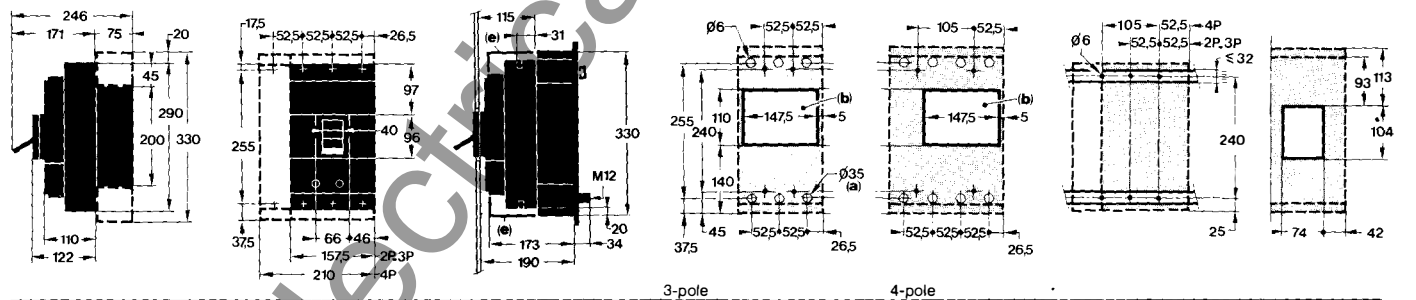

Plug-in equipment

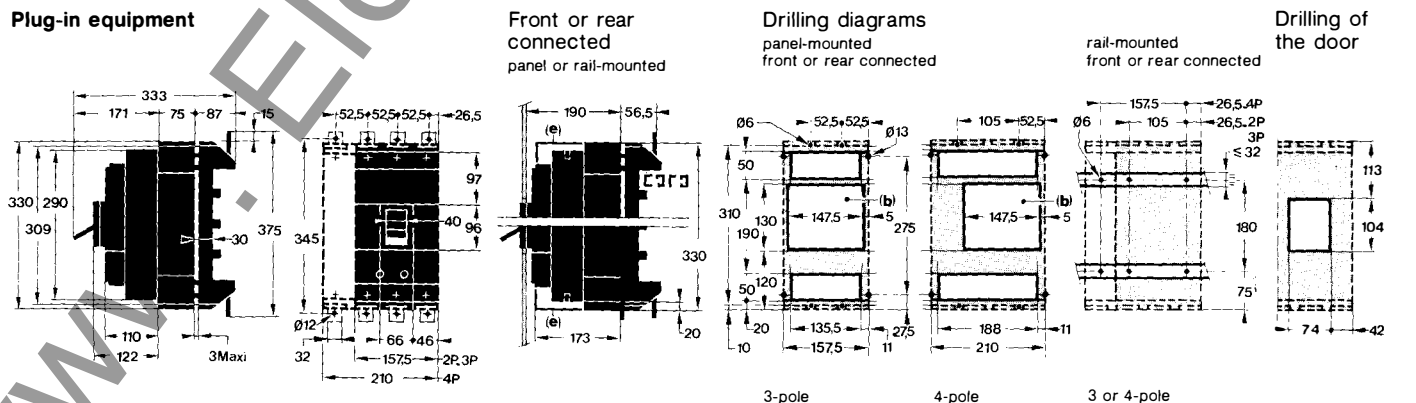

Weight (kg)

type	No of poles	fixed	plug-in with base
C401/C630N/H, C401/C630NI	2	4.3	6.1
C400/C630N/H ST, C400/C630NI	3	5.4	8.9

**Vigicompact C401/C630N/H,
C400/C630N/H ST,
Visucompact and
earth leakage Visucompact
C401/C630N, C400/C630N ST**

**Vigicompact C401/C630N/H,
C400/C630N/H ST**

Front or rear
connected
panel or rail-mounted

Drilling diagrams
panel-mounted
front or rear connected

rail-mounted
front connected

Drilling of
the door

Fixed equipment

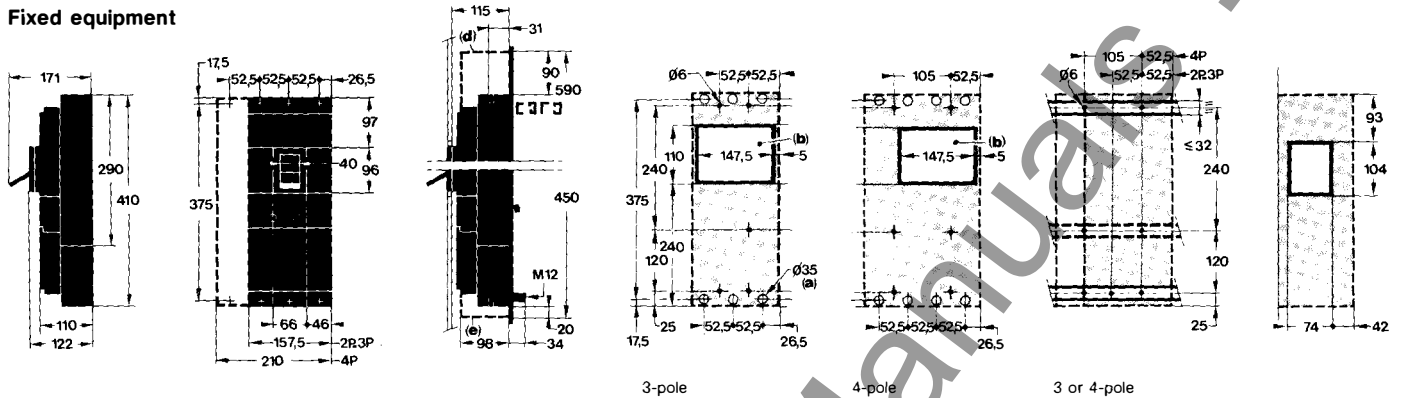

Plug-in equipment

Front or rear
connected
panel or rail-mounted

Drilling diagrams
panel-mounted
front or rear connected

panel-mounted
front connected

Drilling of
the door

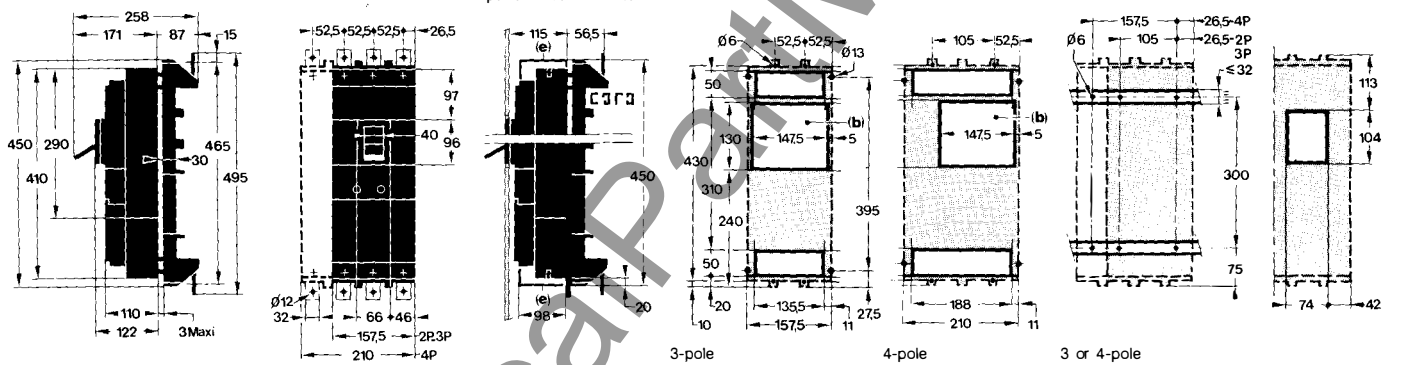

**Visucompact C401/C630N,
C400/C630N ST**

Front or rear
connected
panel or rail-mounted

Drilling diagrams
panel-mounted
front or rear connected

rail-mounted
front connected

Drilling of
the door

Fixed equipment

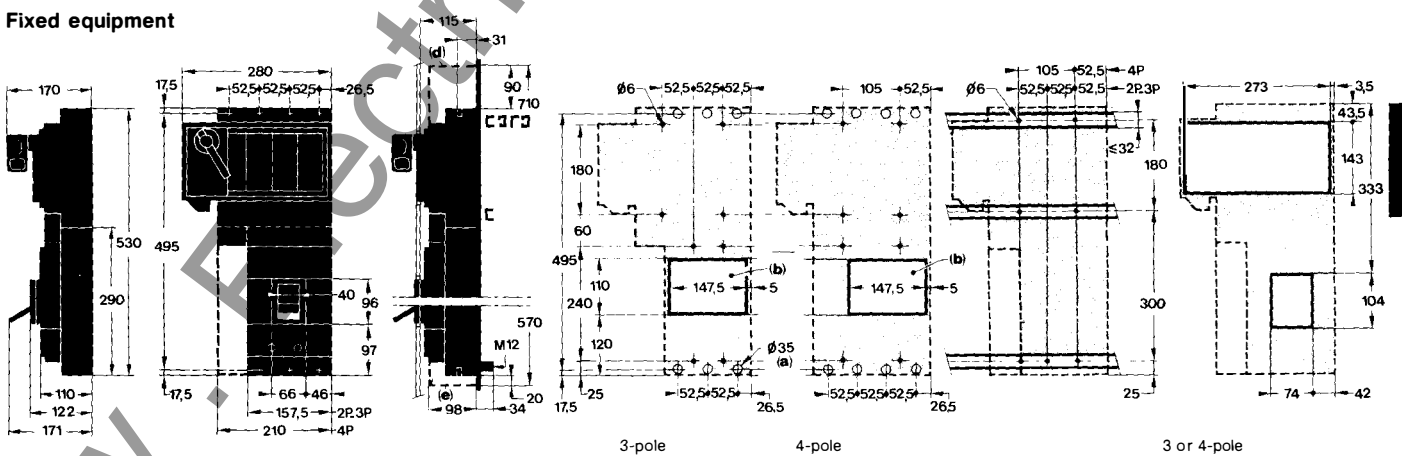

**earth leakage Visucompact
C401/C630N
C400/C630N ST**

The size of the earth leakage Visucompact is identical to the one of the Visucompact (see above), except that the height is 120 mm greater.

Thus:

- the height dimension changes from 530 to 650.
- the lower mounting holes should be repeated 120 mm lower.

Weight (kg)

type	No of poles	fixed	plug-in with base
Vigicompact	3	7.8	11.2
C401/C400/C630N	4	9.7	13.3
		10.7	

**Compact
C801 to C1251N/H ST
C801NI, C1251NI
drawout version
Visucompact C801N ST
to C1251N ST**

Drawout equipment (universal chassis)

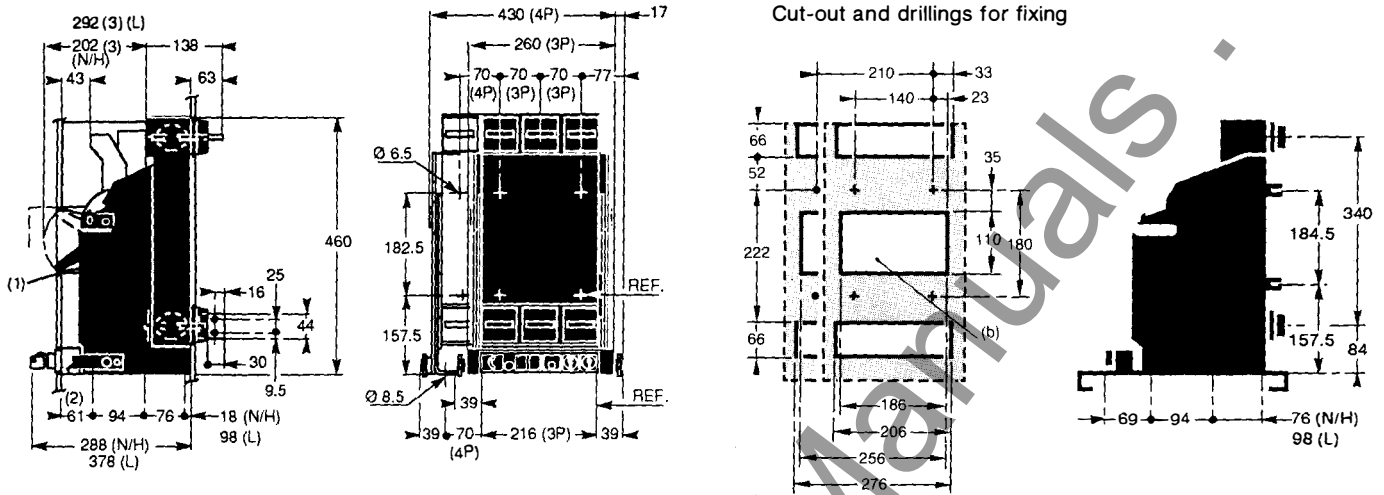

Door cut-out with door sleeve rear fixing

with door escutcheon rear fixing

Door cut-out with door sleeve bottom fixing

with door escutcheon bottom fixing

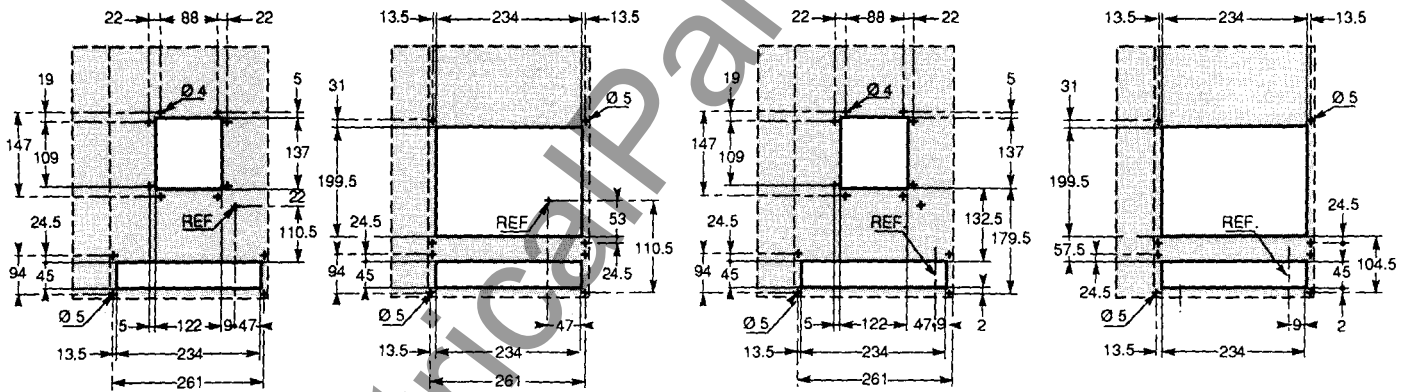

Visucompact C801 to C1251N ST

Fixed FC

Cut-out and drillings for fixing:
on rail mounted

Door cut-out

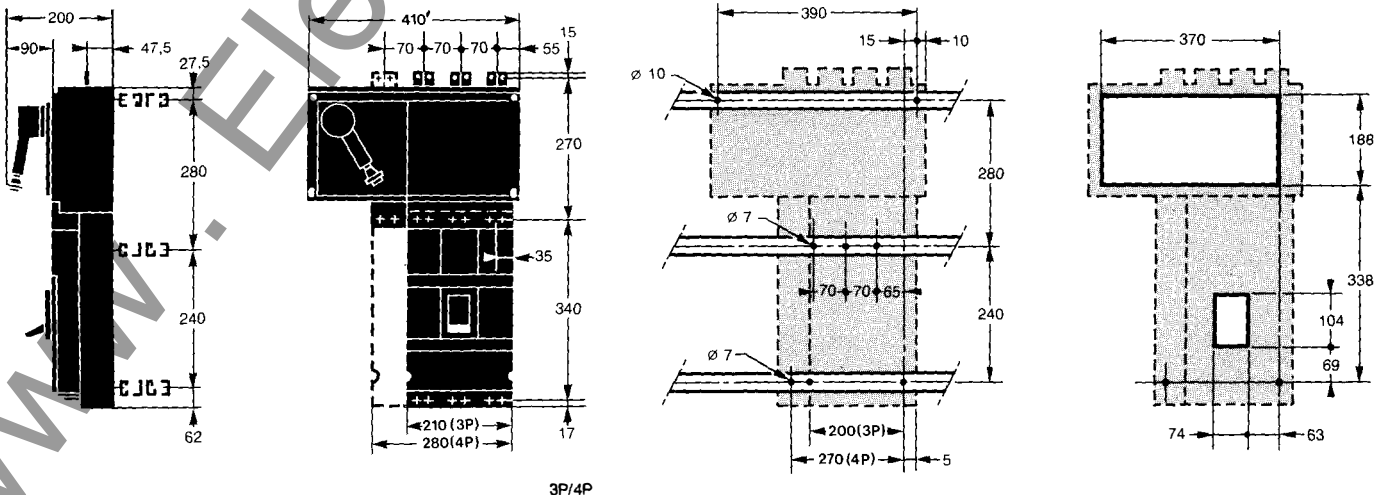

3P/4P

dimensions chassis for withdrawable CB

for Compact C161N/H/L to
C1251N/H ST

standard chassis for withdrawable CB

for Compact C161 to C630N/H/L ST

Drilling diagram
panel

rail-mounted

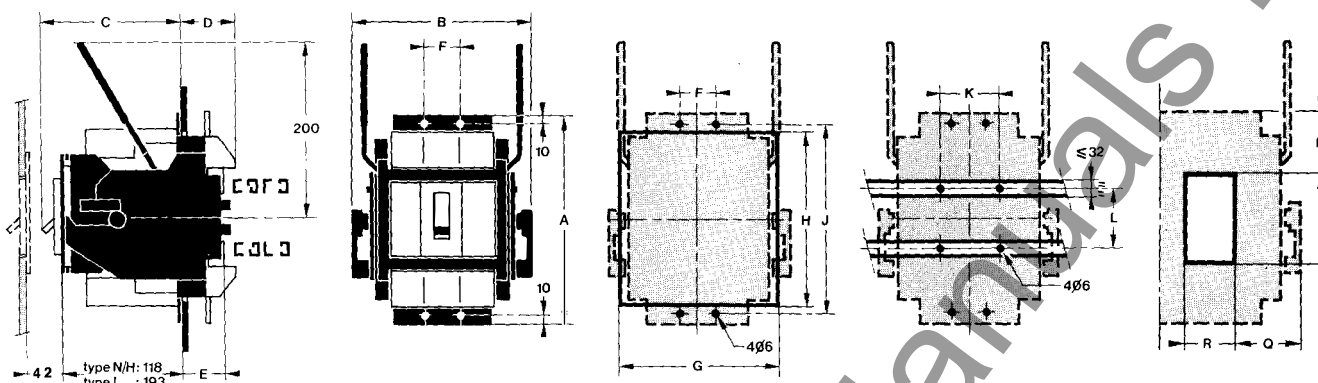

dimensions (mm)

		A	B	C	D	E	F	G	H	J	K	L	M	N	P	Q	R
C161N/H	3P	207	182	142	60	57	35	156	165	187.5	61	60	140	59.5	88	66	50
	4P	207	217	142	60	57	70	191	165	187.5	96	60	140	59.5	88	66	50
C161L	3P	207	182	217	60	57	35	156	165	187.5	61	60	140	59.5	88	66	50
	4P	207	217	217	60	57	70	191	165	187.5	96	60	140	59.5	88	66	50
C250N/H	3P	330	217 ⁽¹⁾	148	70	27	69	196	272	310	90	120	180	121	88	83.5	50
	4P	330	262 ⁽¹⁾	148	70	27	114	241	272	310	135	120	180	121	88	83.5	50
C250L	3P	330	217 ⁽¹⁾	223	70	27	69	196	272	310	90	120	180	121	88	83.5	50
	4P	330	262 ⁽¹⁾	223	70	27	114	241	272	310	135	120	180	121	88	83.5	50
C401N/H to C630N/H ST	3P	390	235	174	87	27	76.5	214	332	370	105	180	180	143	104	80.5	74
	4P	390	288	174	87	27	129	267	332	370	157.5	180	180	143	104	80.5	74
C401L to C630L ST	3P	390	235	249	87	27	76.5	214	332	370	105	180	180	143	104	80.5	74
	4P	390	288	249	87	27	129	267	332	370	157.5	180	180	143	104	80.5	74

(1) For Compact C250N/H/L with motor mechanism: the dimensions B is to be increased of 9 mm (on the neutral side).

for Compact C801N/H/L ST to C1251N/H ST

Drilling diagram
panel

rail-mounted

Door cut-out

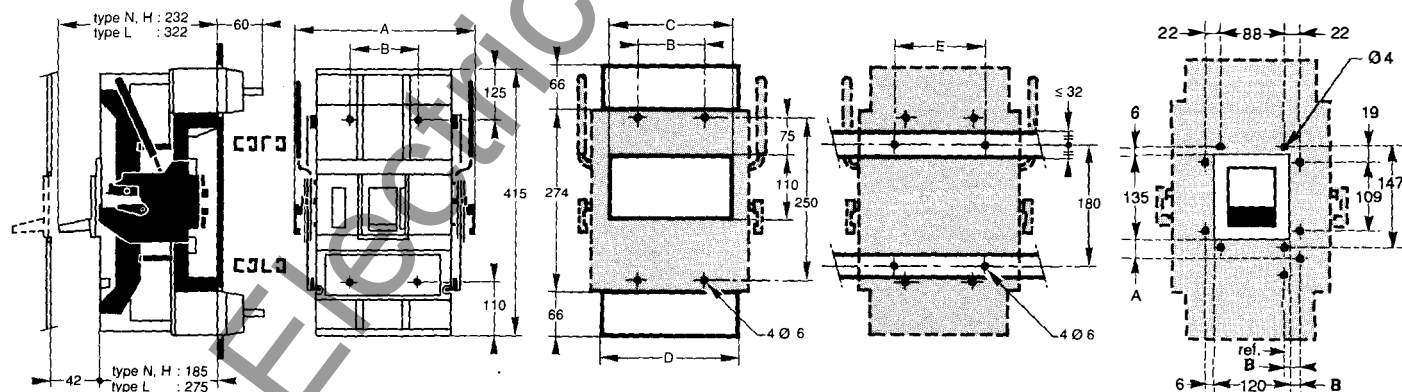

dimensions (mm)

		A	B	C	D	E
C801N/H/L ST to C1251N/H ST	3P	292	105	186	206	140
	4P	362	175	256	276	210

dimensions rotary handles

for Compact
C101 to C1251N/H ST

direct rotary handle

Compact C101 to C630N/H/L

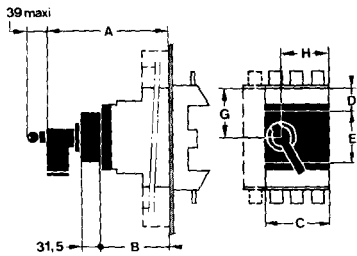

Compact C801 to C1251N/H ST

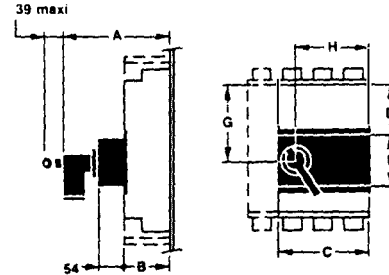

Dimensions (mm)

	A	B	C	D	E	G	H
C101N/H/L	193	110	105	24	80	64	74
C161N/H	193	110	105	38,5	80	78,5	74
C161L	268	185	105	38,5	80	78,5	74
C250N/H	193	110	140	46	80	86	91,5
C250L	268	185	140	46	80	86	91,5
C401N/H to C630N/H ST	193	110	157,5	97	96	145	120
C401L to C630L ST	268	185	157,5	97	96	145	120
C801 to C1251N/H ST	216	110	210	141,5	123	200,5	179
C801L	306	200	210	141,5	123	200,5	179
C1001L							

MCC type

rear door mounted

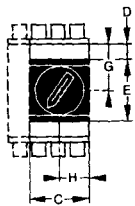
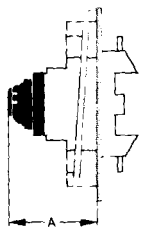

Direct handle through the door

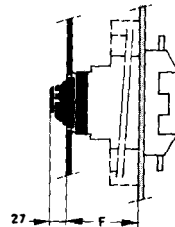

Drilling of the door

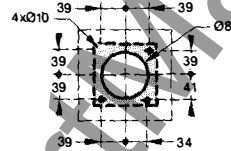

Dimensions (mm)

	A	C	D	E	F	G	H
C101N/H/L	157	105	1,5	105	130	54	52,5
C161N/H	167	105	19	105	140	71,5	52,5
C161L	242	105	19	105	215	71,5	52,5
C250N/H	167	140	38,5	105	140	91	81
C250L	242	140	38,5	105	215	91	81

extended rotary handle

with door locking
front door mounted

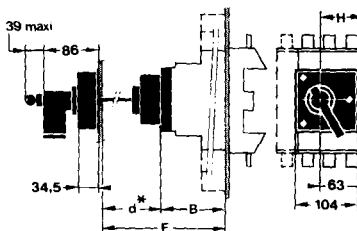

Drilling of the door

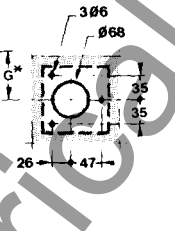

rear door mounted

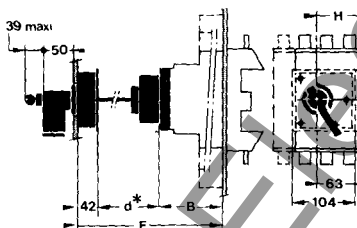

Drilling of the door

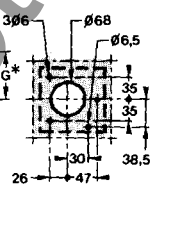

Dimensions (mm)

	B	F	G*		H
		short shaft mini maxi	long shaft mini maxi		
C101N/H/L	110	186 310	310 500	64*	74
C161N/H	110	186 310	310 500	78,5*	74
C161L	185	261 385	385 575	78,5*	74
C250N/H	110	186 310	310 500	86*	91,5
C250L	185	261 385	385 575	86*	91,5
C401N/H to C630N/H ST	110	186 310	310 500	145*	120
C401L to C630L ST	185	261 385	385 575	145*	120
C801N/H ST to C1251N/H ST	110	209 333	333 523	200,5*	179
C801L ST to C1001L ST	110	290 423	423 613	200,5*	179

* to balance the vertical play of the axis according to distance d (equal to F-B), dimension G is to be increased of:

- 0 mm for $d < 200$ when using a bracket (see accessories pages).
- 1 mm for $76 \leq d \leq 120$
- 2 mm for $120 \leq d < 160$ without a bracket
- 3 mm for $160 \leq d < 200$
- 0 mm for $d \geq 200$ (large length shaft always supplied with bracket).

without door locking
front door mounted

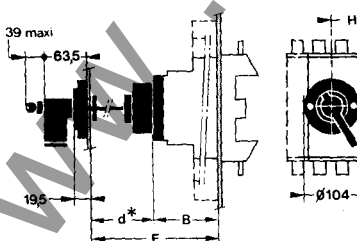

Drilling of the door

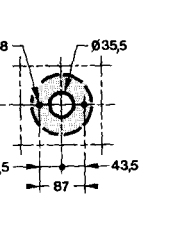

dimensions remote control

motor mechanism T101

Fixed or plug-in equipment

Door cut-out

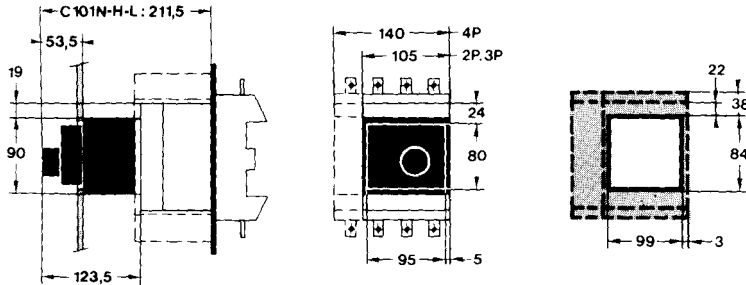

Approximate weight: 720 g

motor mechanism T161

Fixed or plug-in equipment

Door cut-out

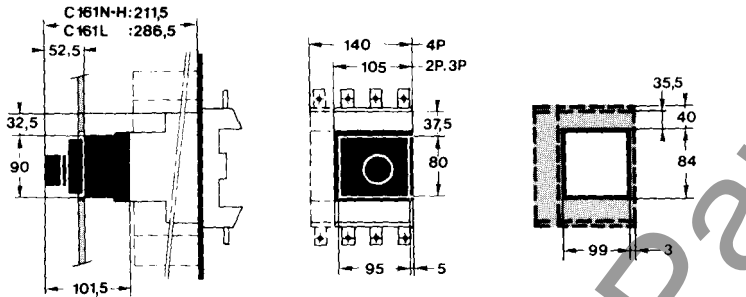

Approximate weight: 720 g

motor mechanism TS161

Fixed or plug-in equipment

Door cut-out

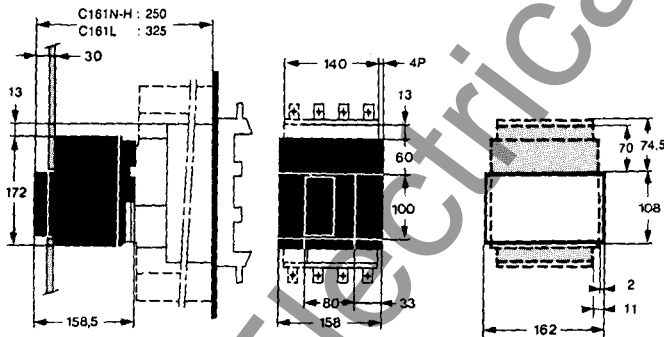

Approximate weight: 3 600 g

motor mechanism T250 and TS250

for Compact C250N/H/L
Fixed or plug-in equipment

Drilling
of the door

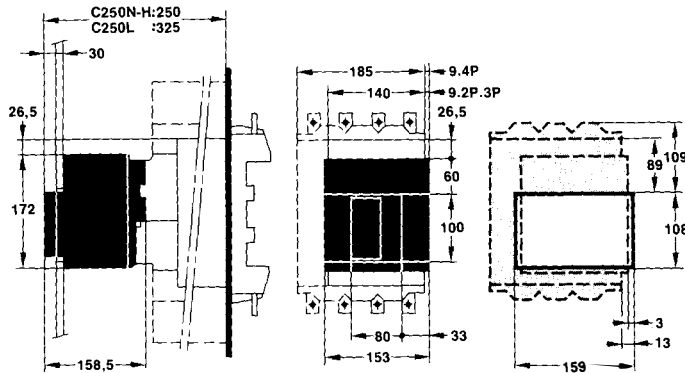

motor mechanism T401/400/630 and TS401/400/630

for Compact C401/C400/C630N/H/L
Fixed or plug-in equipment

Drilling
of the door

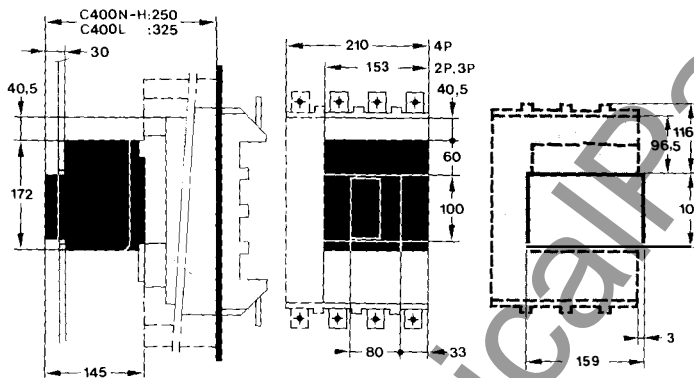

motor mechanism T801/1001/1251 and TS801/1001/1251

for Compact C801 to C1251N/H/L ST
T type

Fixed equipment

Drilling
of the door

TS type
Fixed equipment

Drilling
of the door

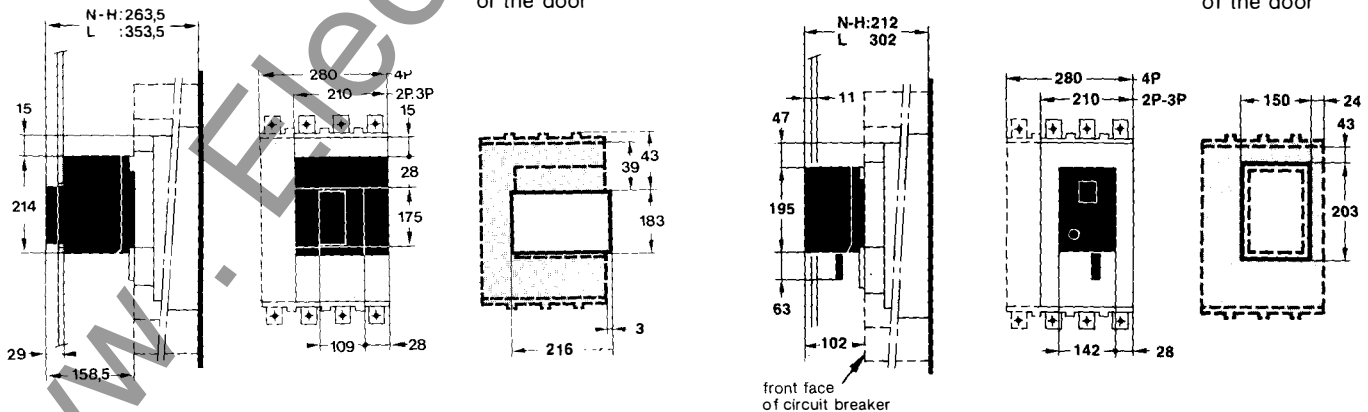

Drawout equipment:
The dimensions of the remote control
modules on Compact drawout circuit
breakers C801/1001 and 1251N/H/L and

the corresponding door cutouts are
identical to those indicated above for the
remote control modules on fixed circuit
breakers.

Weight (kg)
motor mechanism _____ weight
for _____

dimensions automatic source changeover

with 2 Compact
C101N/H/L
to C1251N/H

Compact changeover C101N/H/L to C161N/H/L

Fixed equipment

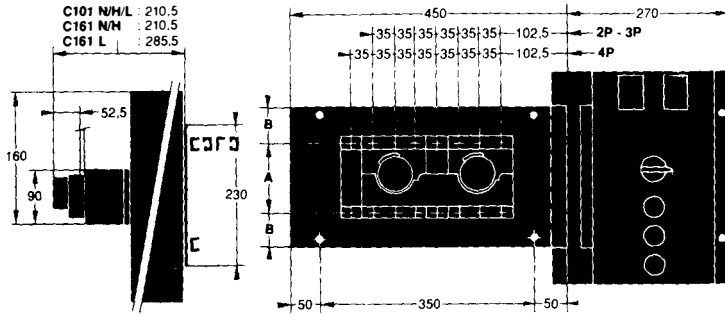

Drilling diagrams
horizontal rails mounted

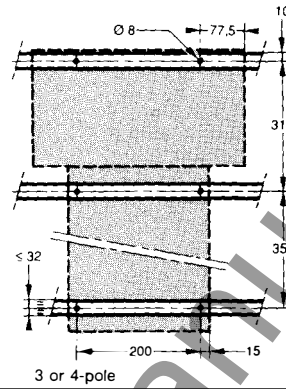

vertical rails mounted

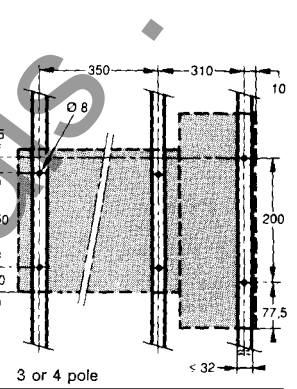

Compact changeover C250N/H/L

Fixed equipment

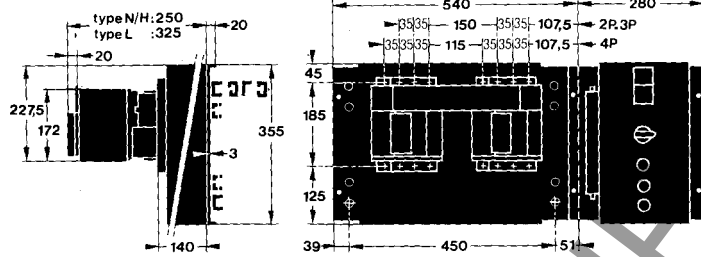

Drilling diagrams
horizontal rails mounted

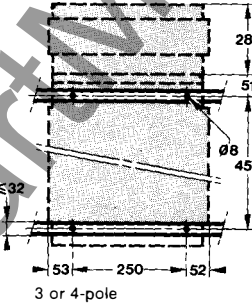

vertical rails mounted

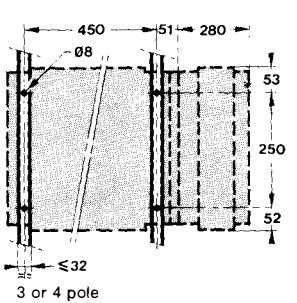

Compact changeover C401N/H/L to C630N/H/L ST

Fixed equipment

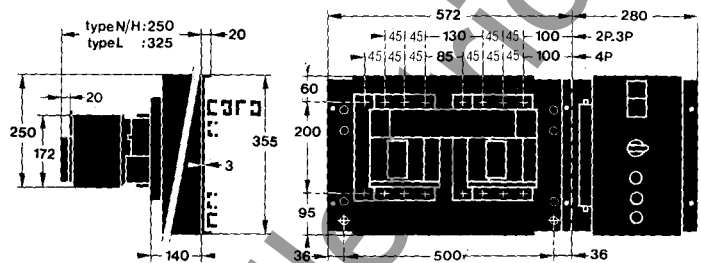

Drilling diagrams
horizontal rails mounted

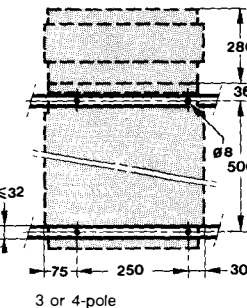

vertical rails mounted

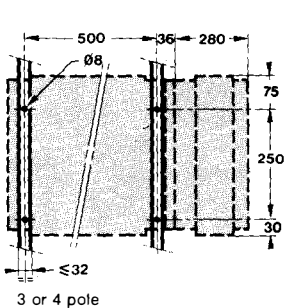

Compact changeover C801N/H/L to C1251N/H ST

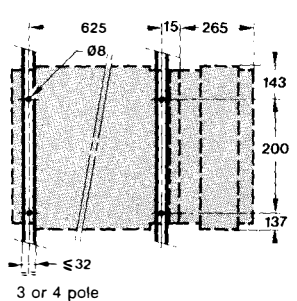
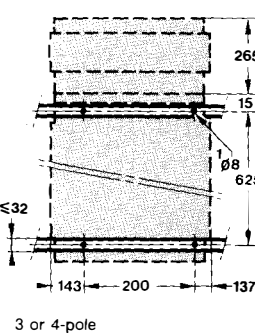
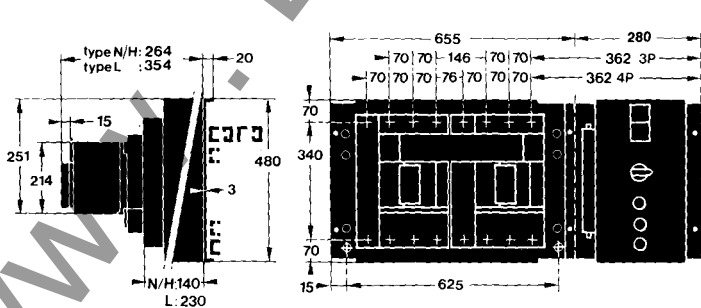

Weights (kg)

type	3P	4P	type	3P	4P
C250N/H	26.8	27.8	C401N/H to C630N/H ST	30.2	32.4
C250L	36.4	39.4	C401L to C630L ST	39.4	43.8

mechanical interlocking
Compact C101N/H/L to C630N/H/L
 with direct rotary handle

Drilling diagram
 panel or rail-mounted

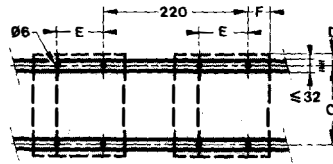
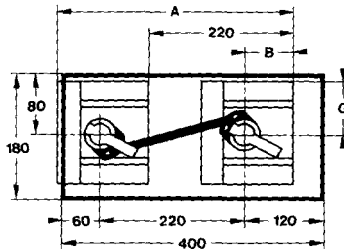
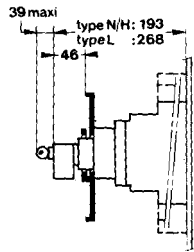

	A	B	C	D	E	F	G
	3P	4P			3P	4P	
C101	325	360	74	90	19	35	70 35 64
C161	325	360	74	120	17,5	35	70 35 78,5
C250	360	405	91,5	180	25	45	90 47,5 91,5
C401	377,5	430	122	240	25	52,5	105 52,5 122
to C630 ST							

3 or 4-pole

mechanical interlocking
Compact C801 to C1251N/H/L ST
 with direct rotary handle

Drilling diagram
 panel or rail-mounted

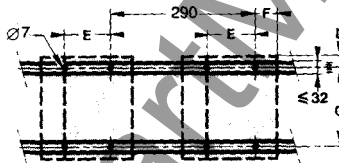
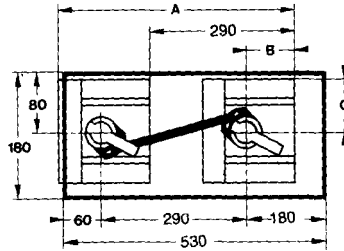
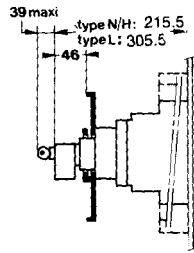

C161N/H/L A	B	C	D	E	F	G
3P 4P				3P 4P		
C801	430	570	179	240	74	140 210 70 200,5
to C1251N/H/L ST						

3 or 4-pole

dimensions Interpact IN63T to IN2500

IN63T to IN630

Interpact IN63T

Fixed equipment

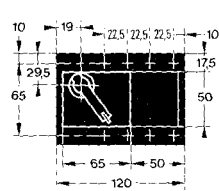

Front or rear connected
panel or rail-mounted

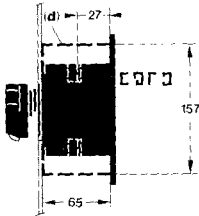

Drilling diagrams
panel-mounted
front or rear connected

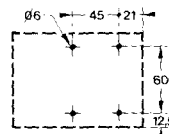

3 or 4-pole

rail-mounted
front connected

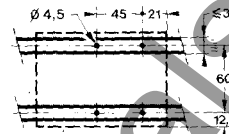

3 or 4-pole

Drilling of
the door

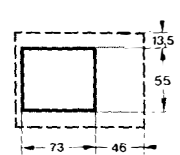

Interpact IN125T/IN160T

Fixed equipment

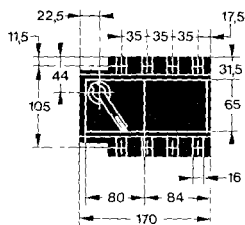
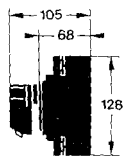

Front or rear connected
panel or rail-mounted

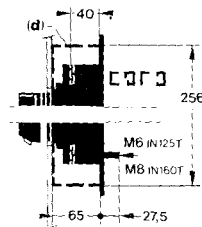

Drilling diagrams
panel-mounted
front or rear connected

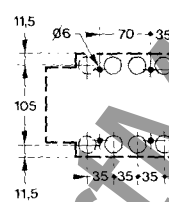

3 or 4-pole

rail-mounted
front connected

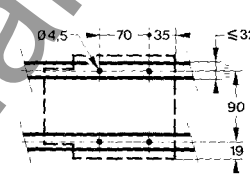

3 or 4-pole

Drilling of
the door

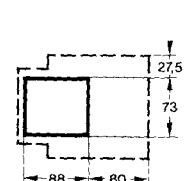

Interpact IN250

Fixed equipment

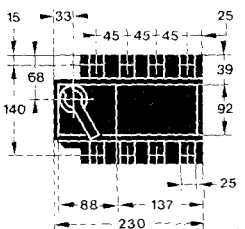
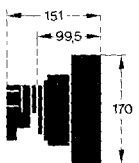

Front or rear connected
panel or rail-mounted

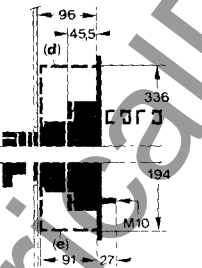

Drilling diagrams
panel-mounted
front or rear connected

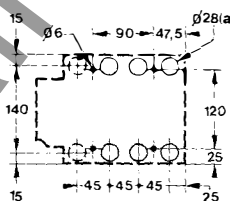

3 or 4-pole

rail-mounted
front connected

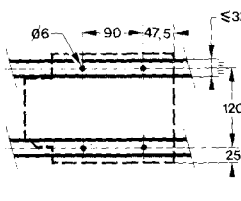

3 or 4-pole

Drilling of
the door

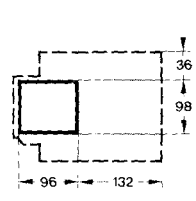

Interpact IN400/IN630

Fixed equipment

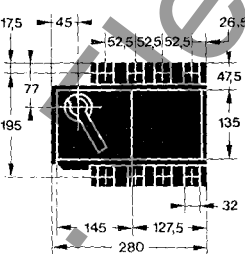
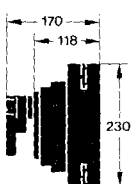

Front or rear connected
panel or rail-mounted



Drilling diagrams
panel-mounted
front or rear connected

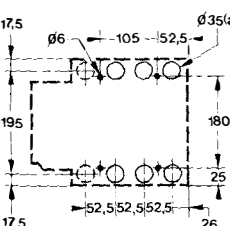

3 or 4-pole

rail-mounted
front connected

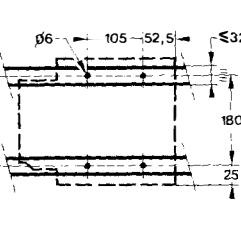

3 or 4-pole

Drilling of
the door

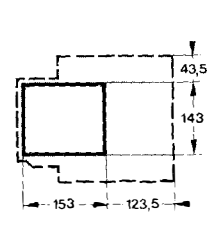

WWW.TECHNICALSOLUTIONS.COM

dimensions

Interpact IN63T to IN2500 (continued)

rotary handle

mechanical interlocking

extended rotary handle

Interpact IN63T to IN630

Interpact IN1000 to IN2500

Drilling of the door

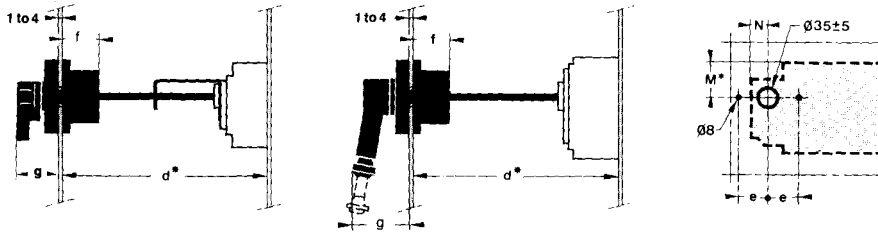

Dimensions (mm)

type	M	N	d*		e	f	g
			mini	maxi			
IN63T	29.5	19	180	306	35	50	44
IN125T	44	22.5	180	306	35	50	44
IN160T							
IN250	68*	33	180	306	43.5	45.5	65
IN400	77*	45	180	306	43.5	45.5	65
IN630							
IN1000	67.5*	65	180	306	43.5	46.5	97
IN1600							
IN2500	67.5*	65	22	388	43.5	46.5	97

* To balance the vertical play of the axis dimension M is to be increased of 3 mm for d > 220mm.

lateral rotary handle

Interpact IN63T to IN160T

Drilling of the door

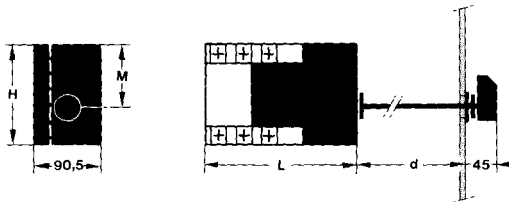

Dimensions (mm)

Interpact	H	L	M	d	
				mini	maxi
IN63T	118	155	67	30	200
IN125T	132	202	84	30	200
IN160T					

mechanical interlocking

Interpact IN63T to IN160T

Drilling diagram

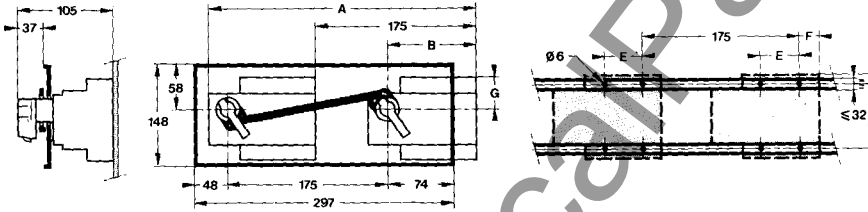

Dimensions (mm)

Interpact	A	B	C	D	E	F	G
IN63T	295	101	60	12.5	45	21.5	29.5
IN125T	345	147.5	90	19	70	35	44
IN160T							

3 or 4-pole

Interpact IN250 to IN630

Drilling diagram

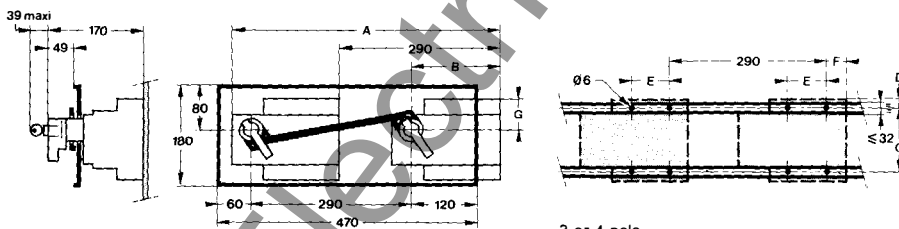

Dimensions (mm)

Interpact	A	B	C	D	E	F	G
IN250	522	199	120	25	90	47.5	68
IN400	570	235	180	25	105	52.5	77
IN630							

3 or 4-pole

Weight (kg)

type	No of poles		type	No of poles	
	3	4		3	4
IN63T	0.75	0.80	IN630	4.8	5.3
IN125T	1.4	1.5	IN1000	12	15

dimensions

Fupact UC50 to UD630T

Fupact UC50

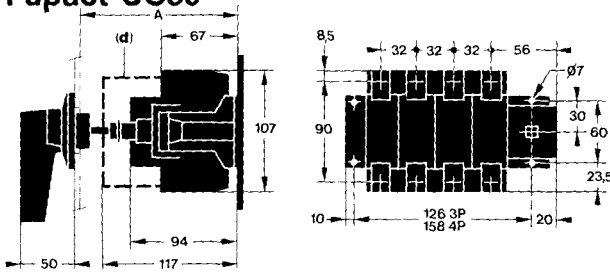

Fupact UD63

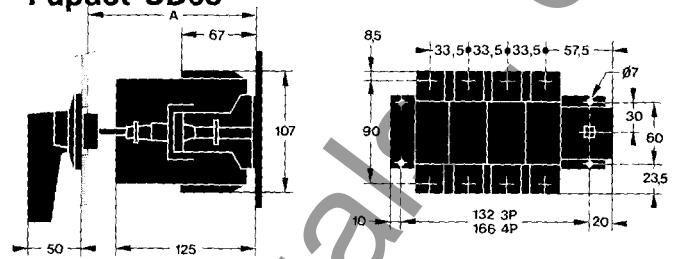

Fupact UC125/UD125/UD160

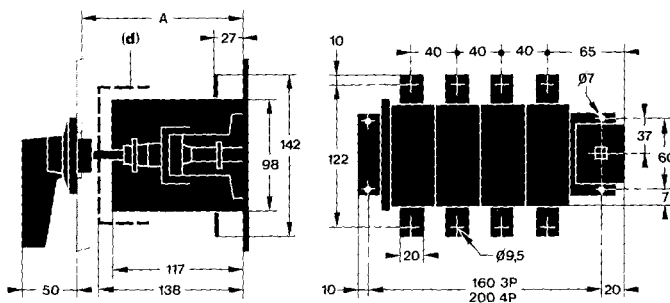

Fupact UD250T

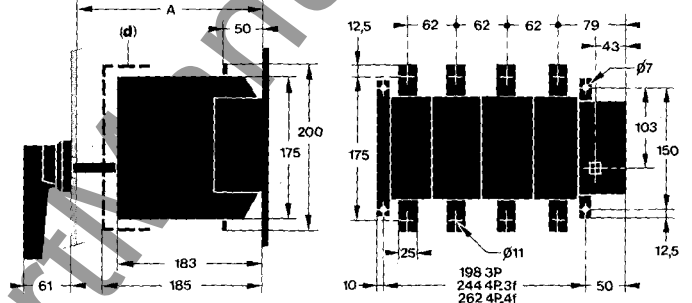

Fupact UD400T

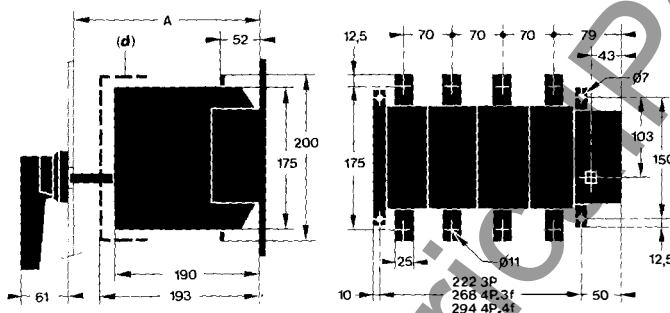

Fupact UD630T

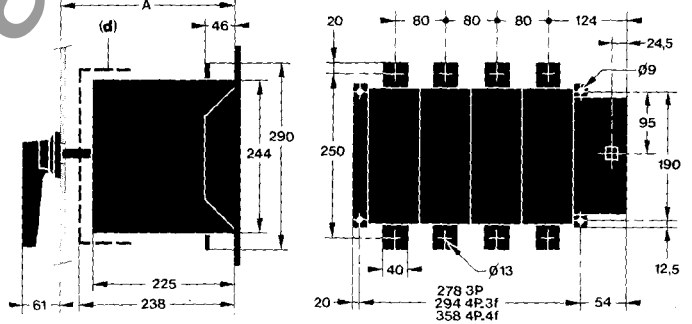

Adjustment limits of the length of the shaft

type	A (mm)	
	short shaft	long shaft
UC50	140-200	262-340
UD63	140-200	220-360
UC125, UD125, UD160	145-200	230-360
UD250T, UD400T	235-345	445-555
UD630T	260-350	340-420

Drilling of the door

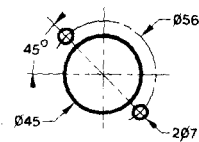

Compact C100E

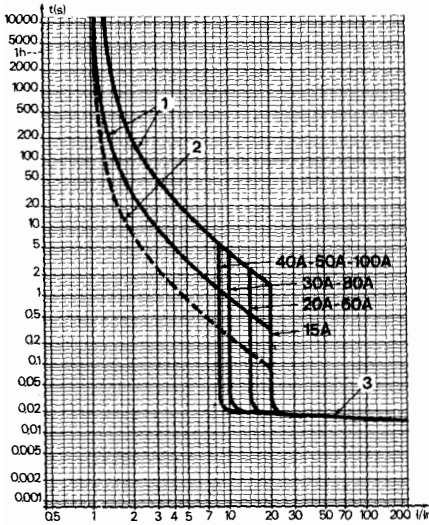

ambient compensation

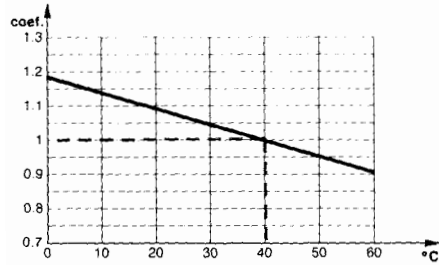

Compact C225E
trip unit release D125, D150

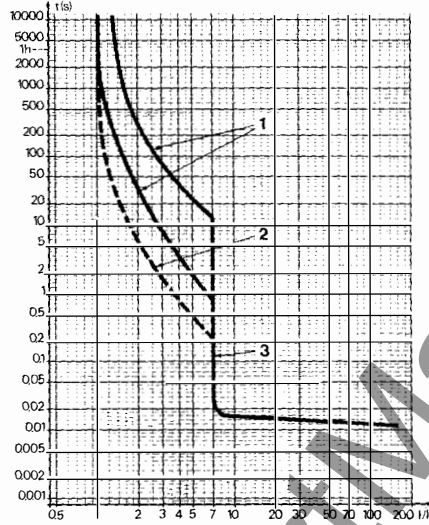

ambient compensation

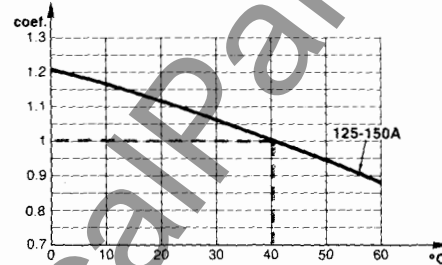

Compact C400E

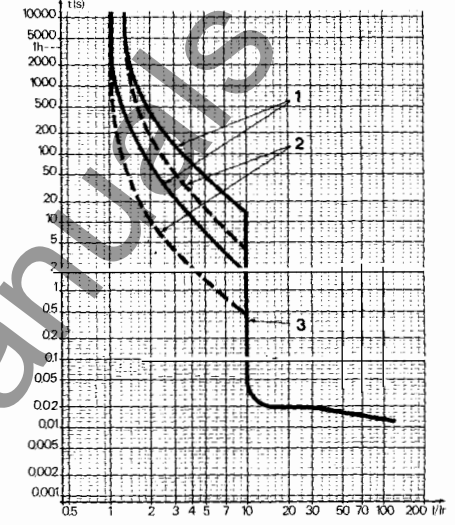

ambient compensation

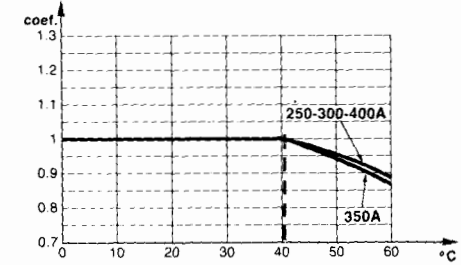

Compact C225E
trip unit release D175, D225

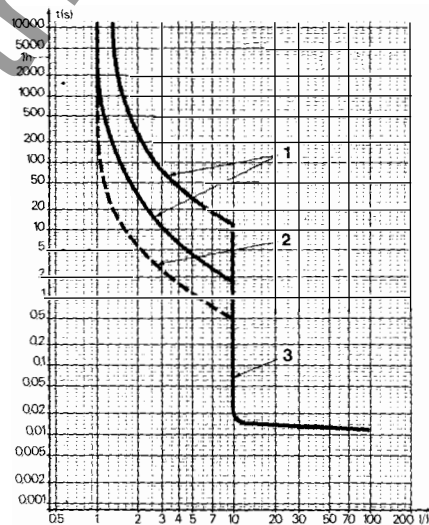

ambient compensation

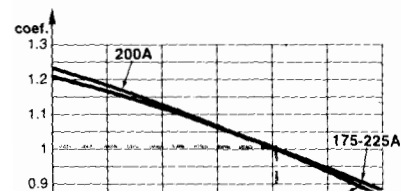

Compact C600E

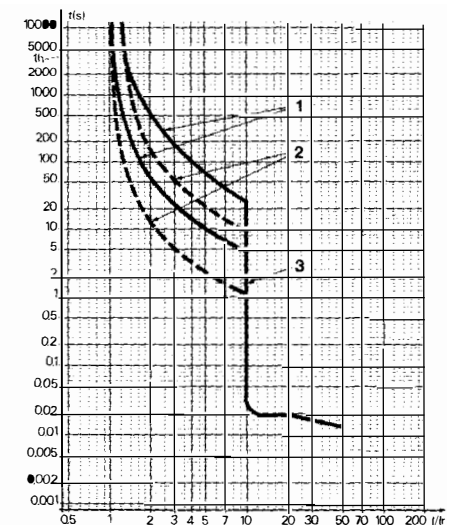

ambient compensation

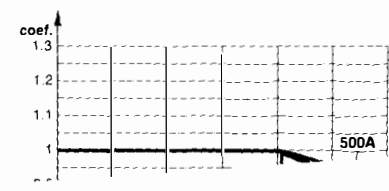

Here after the following curves:

- 1: mini and maxi thermal cold start tripping,
- 2: mini and maxi thermal hot start tripping,
- 3: magnetic threshold

Note

the variation of the tripping time is given according to I/I_r (I = real current, and I_r = maximum value of the breaking trip unit rating for the ambient temperature

Compact C100NF (1P)

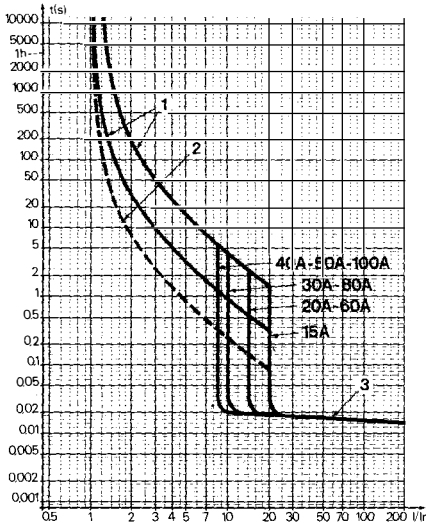

ambient compensation

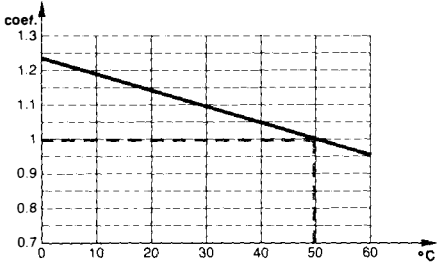

Compact C101N/H

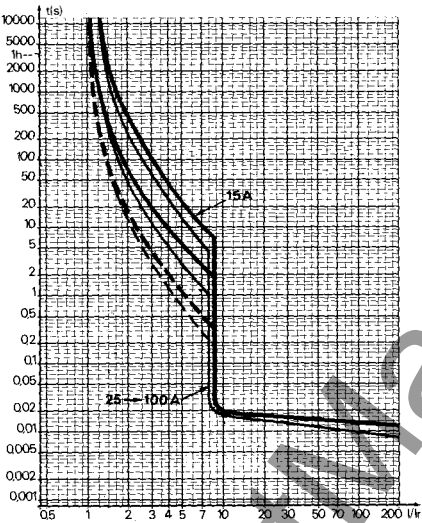

ambient compensation

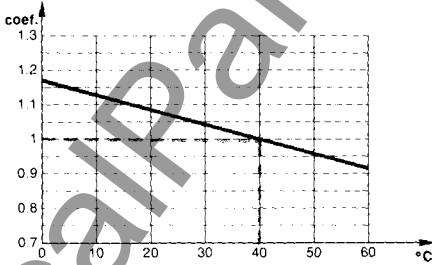

Compact C161N/H

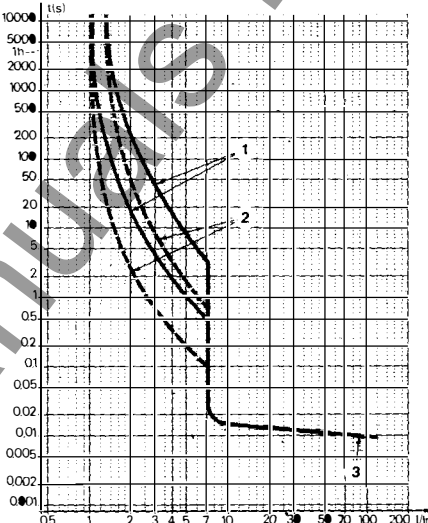

ambient compensation

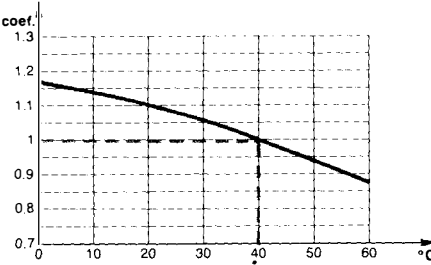

Compact C101L

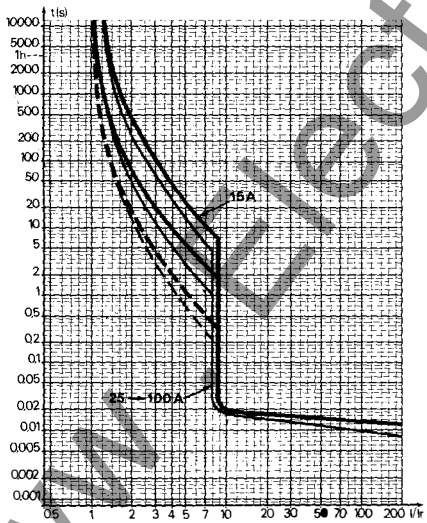

ambient compensation

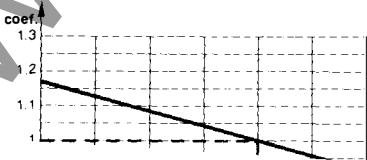

Compact C161L

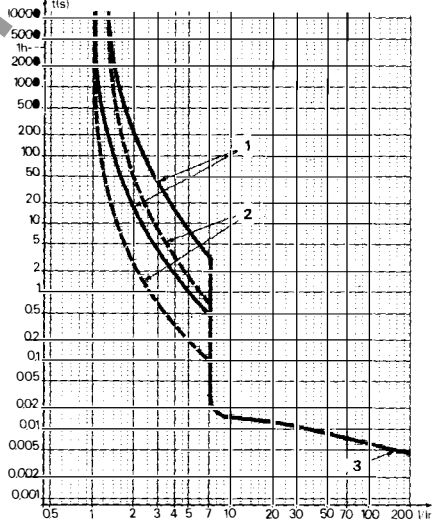

ambient compensation

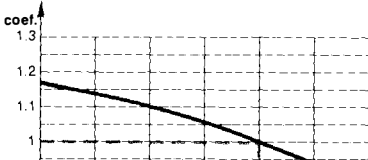

tripping curves

Compact C250N/H/L to C630N/H/L

Compact C250N/H

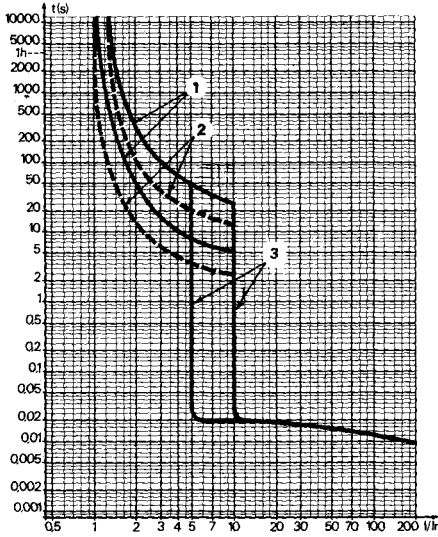

ambient compensation

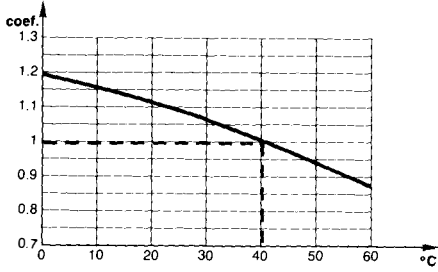

Compact C401N/H

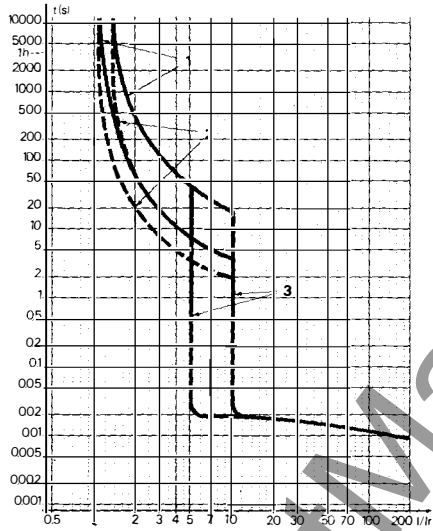

ambient compensation

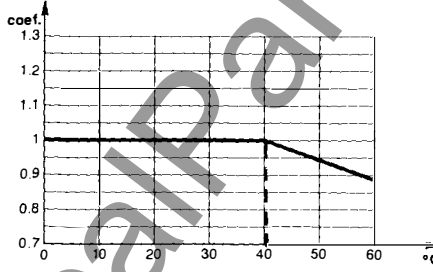

Compact C630N/H

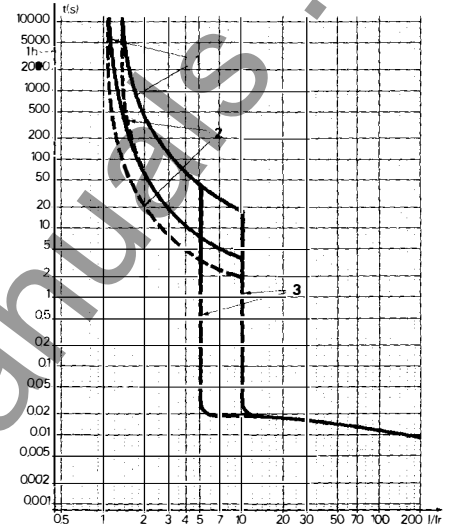

ambient compensation

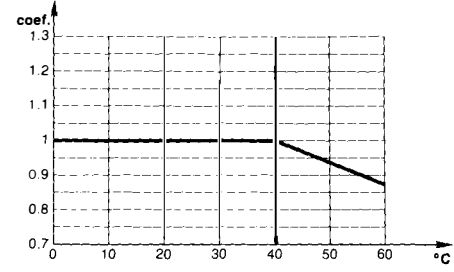

Compact C250L

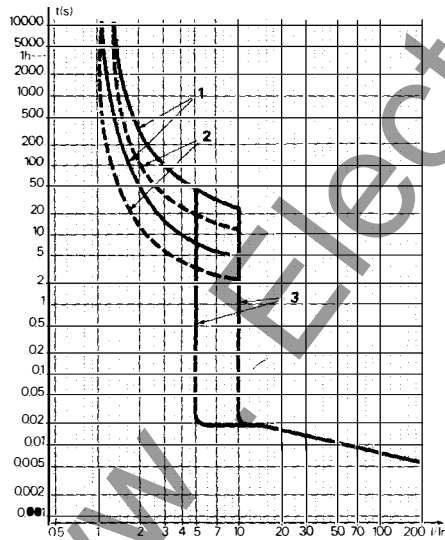

ambient compensation

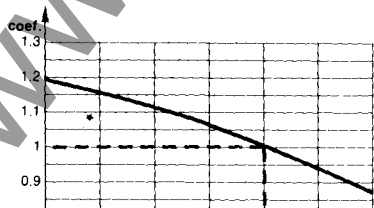

Compact C401L

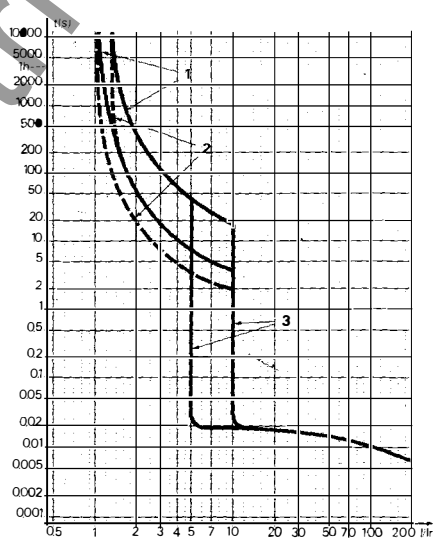

ambient compensation

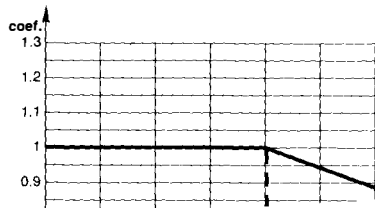

Compact C630L

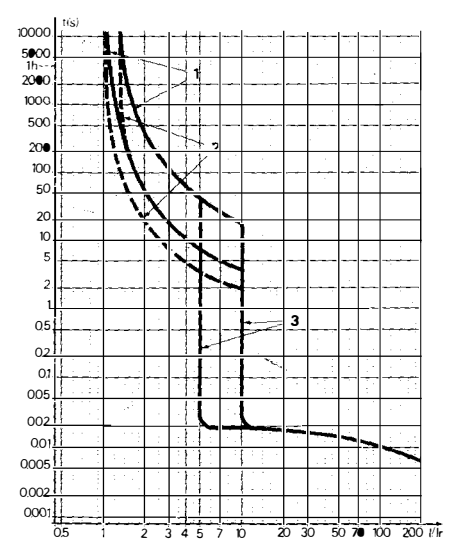

ambient compensation

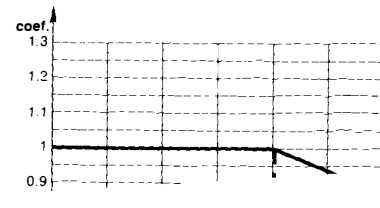

Compact C400N/H/L ST and C630N/H/L ST
 ST204S control unit

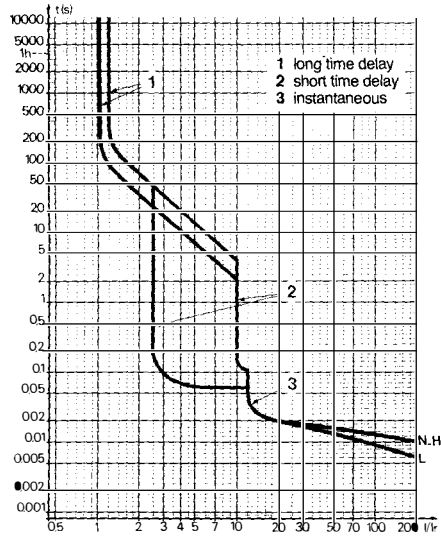

I_r = long time delay protection threshold (L.R)

Compact C801N/H/L ST to C1251N/H ST
 STR25DE control unit

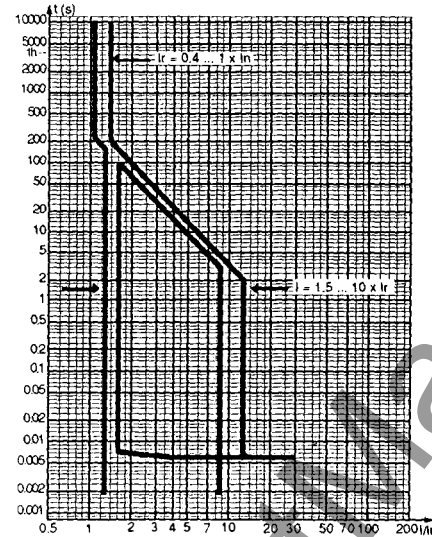

I_n = current rating of sensor
 I_r = long time setting
 I_m = instantaneous pick-up

Compact C801N/H/L ST to C1251N/H ST
 STR35SE/ME control unit

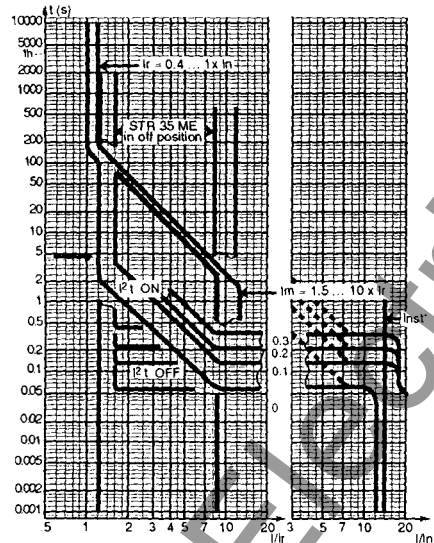

I_n = current rating of sensor
 I_r = long time setting
 I_m = short time pick-up (time band delay 0 - 0.1 - 0.2 - 0.3)
 --- If $I_r = I_n$

*INST	C801 - C1001 N-H	C801 - C1001 L	C1251 N-H
xIn	15	8	12

Compact C801N/H/L ST to C1251N/H ST
 STR35GE control unit

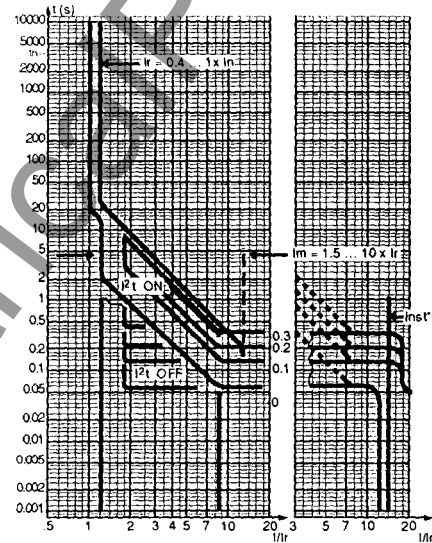

I_n = current rating of sensor
 I_r = long time setting
 I_m = short time pick-up (time band delay 0 - 0.1 - 0.2 - 0.3)
 --- If $I_r = I_n$

*INST	C801 - C1001 N-H	C801 - C1001 L	C1251 N-H
xIn	15	8	12

Compact C801N/H/L to C1251N/H ST
STR45BE control unit

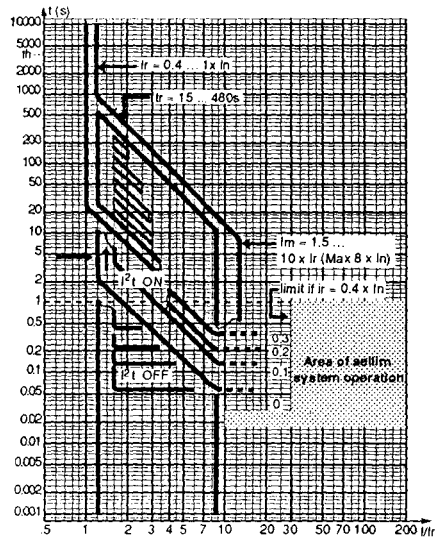

I_n = current rating of sensor
 I_r = long time setting
 t_r = time band delay
 I_m = short time pick-up (time band delay 0 - 0.1 - 0.2 - 0.3)

Compact C801N/H/L ST to C1251N/H ST
STR55UE control unit

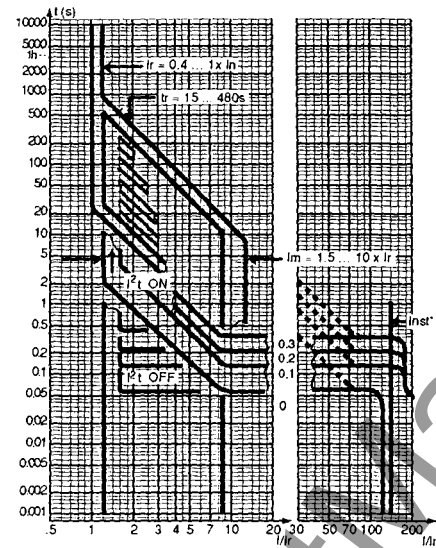

I_n = current rating of sensor
 I_r = long time setting
 t_r = time band delay
 I_m = short time pick-up (time band delay 0 - 0.1 - 0.2 - 0.3)
 ----- = if $I_r = I_n$

INST adjustable from 2 I_n to

C801-C1001 N-H	C801-L-C1001 L	C1251 N-H
X I_n 15	8	12

Compact C801N/H/L ST to C1251N/H ST
Earth fault protection (T)

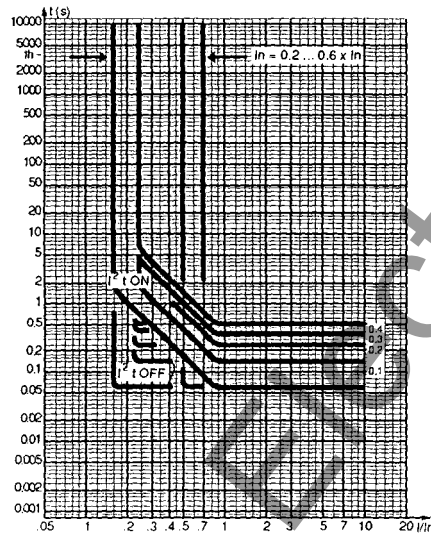

I_n = current rating of sensor
 I_h = earth fault pick-up
 (time band delay 0.1 - 0.2 - 0.3 - 0.4)

Compact C801N/H/L ST to C1251N/H ST
Load monitoring (R)

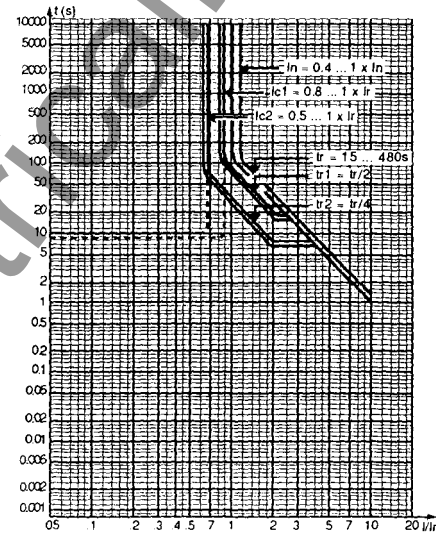

I_n = current rating of sensor
 I_r = long time setting
 ----- closing of contacts
 - - - - - opening of contacts



ambient compensation of C400N/H/L ST

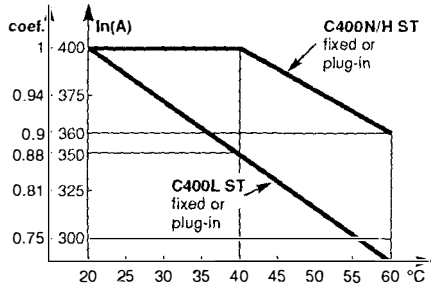

ambient compensation of C630N/H/L ST

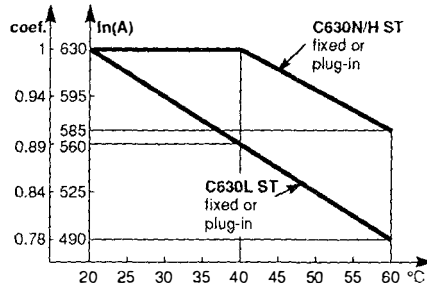

ambient compensation of C801N/H/L ST

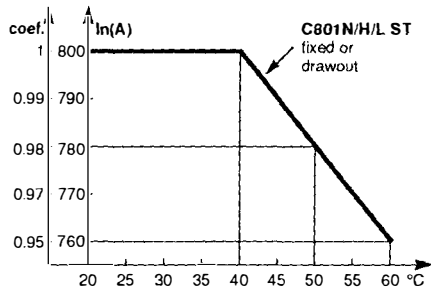

ambient compensation of C1001N/H/L ST

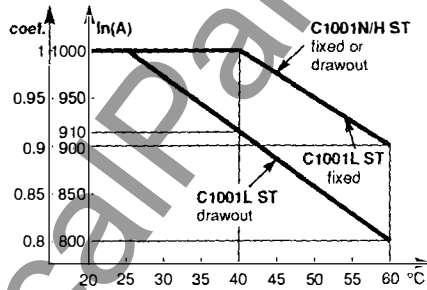

ambient compensation of C1251N/H/L ST

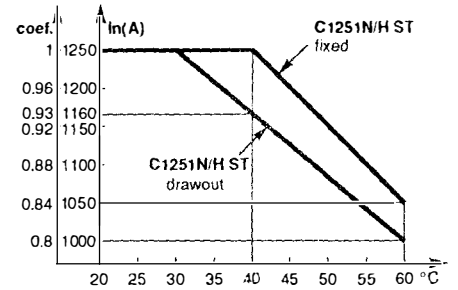

Compact 11 to 1 250 A moulded case circuit breakers: typical specifications

general

- MCCB shall comply with IEC 947-2 or corresponding standards in member countries (BS 4752; VDE 0660; UTE 63120).

The breaking capacities of the circuit breakers shall be at least equal to the prospective fault level at the point of the distribution system where the breakers are installed, unless the limitation capacity of an upstream breaker allows cascading.

- all MCCB shall be designed for horizontal or vertical mounting without any adverse effect on electrical performance.
- if shall be possible to reverse feed the breaker without reduction in performance.
- they shall be available in fixed, plug-in or withdrawable models and in 3-pole or 4-pole versions.

construction

- operating mechanism shall be of the quick make break type, with the speed of operation independent of the operator, and mechanically trip free from the operating handle so as to prevent the contacts from being held closed against short circuit and overload conditions. The operating mechanism shall be constructed to operate all poles in a multi-pole breaker simultaneously during opening, closing and tripped conditions.

- the breakers shall be operated by a toggle which shall clearly indicate the three fundamental positions ON, OFF and TRIPPED.
- if required, rotary handles can equip the breaker.

- the breaking and extinction of the electrical arc shall be achieved by means of non-welding contacts and an arc chute surrounding these contacts.

- the current limiting MCCB with very high breaking capacity shall be made of two parts:

- a standard circuit breaker to operate on small and medium fault currents
- a current limiter block to operate on large short circuit currents.

- the current limiter block shall be of electro mechanical type (fuse free) and fitted to the standard breaker.

- the standard operating mechanism shall be constructed so that the handle of the circuit breaker indicates the real position of the contacts to ensure a positive break indication.

- the breakers will have a double insulation of the front face allowing field installable auxiliaries without insulating the unit.

- all accessories and electrical auxiliaries such as shunt trip or undervoltage release, auxiliary contact, motor mechanism shall be manufactured in such a way that they can be easily field installable.

- all electrical auxiliaries shall be equipped with built-in control terminals.

- all internal electrical auxiliaries shall be of snap in type.

operation

Each pole of the MCCB shall be provided with bi-metallic thermal element for overload protection and magnetic element for short circuit protection. The thermal release shall be of the adjustable type and could be equipped with sealing facility.

MCCB of 250 A size and above with thermal magnetic trip unit will be provided with interchangeable trip unit.

Above 400 A, the trip unit could be of the solid state type energised by internally mounted current transformer.

It shall not require any external power supply to operate the tripping mechanism.

Compact CM 630 to 3200 A

6 Compact CM

	page
presentation	150
characteristics	154
Visucompact CM1250 to 2500	155
remote control	156
auxiliaries	157
wiring diagrams	158
connection	159
part numbers	160
dimensions	162
tripping curves	164

www.ElectricalPartManuals.com



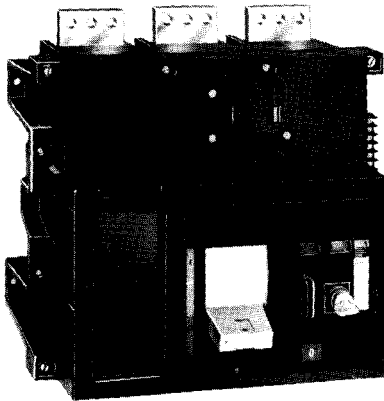

Switch

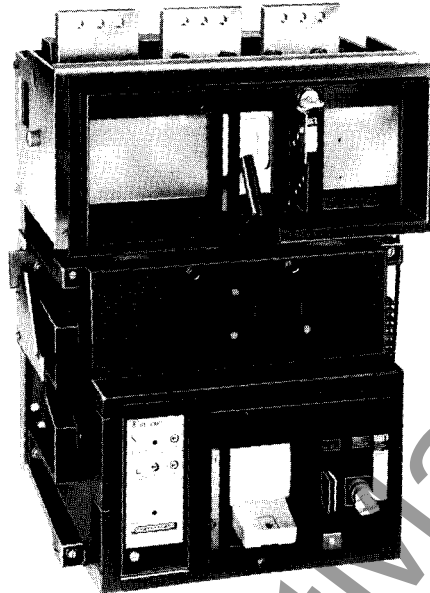

Visucompact

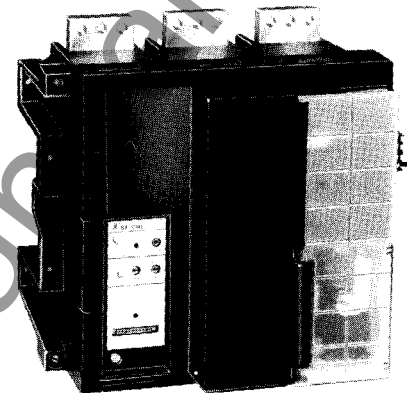

Compact with remote control

choice of the circuit breaker

The source (or incoming) circuit breaker, the main outgoing circuit breakers, and the secondary (or divisional) outgoing circuit breakers should be chosen so that:

- their rating is at least equal to the current rating of the outgoer considered;
- their breaking capacity is at least equal to the short circuit current calculated at the level considered;
- discrimination can be ensured with the downstream protective device.

presentation of the range

The Compact CM1250, CM1600, CM2000, CM2500 and CM3200 circuit breakers extend the Compact range up to 3200A. They benefit from Merlin Gerin's vast experience in insulating moulded cases, and present all the advantages of performance and functions which are the strong points of this range. In particular, they require no maintenance whatsoever. Fitted at the outset with a solid state trip unit, they take another step forward in protection of installations. They exist in three-pole and four-pole versions⁽¹⁾. They are fixed and front connecting. They come in two versions: a standard version and a type H version with a higher breaking capacity.

high performances

Breaking capacity

The breaking capacity is the same whatever the rating of the equipment:

- standard version: 70 kA rms under 380/415 V (according to IEC);
- type H version: 85 kA rms under 380/415 V (according to IEC)⁽²⁾.

Discrimination

The Compact CM enables full discrimination to be obtained with most Compact circuit breakers.

standards

The Compact CM complies with the following standards:

- IEC 947-2
- UTE NF C 63-120
- VDE 0660
- BS 4752
- UL 489 (Special variants)

circuit protection and control function

The CM1250 to CM3200 circuit breakers fitted with the STCM1 trip unit ensure protection and control of circuits.

function of protective device discrimination on short circuits

The CM1250 to CM3200 circuit breakers fitted with STCM2 or STCM3 trip units⁽¹⁾ enable time discrimination to be obtained up to the instantaneous trip threshold (35 kA rms). This characteristic makes full discrimination with most Compact circuit breakers possible.

other functions

Control of circuits

The Compact CM1600I to CM3200I switch is identical in presentation to the Compact CM circuit breaker. Its auxiliaries and accessories are identical to those of the Compact CM.

Positive break indication

The Compact CM gives a positive break indication. The handle can only indicate the "OFF" position if all the contacts are actually open and separated by a suitable distance. Similarly, it is only in this position that padlocking is possible. If the equipment has an auxiliary contact block, this position is also visualised by an additional mechanical indicator.

Visible break disconnection

A variant, the Visucompact CM, complying with French Standard C13-100, performs visible breaking⁽¹⁾.

Remote control

The remote control performs opening and closing of the Compact CM on orders coming from push-buttons, changeover switches or relays. It is fixed to the front face of the circuit breaker.

tropicalisation

The Compact CM circuit breakers, their variants and accessories are tropicalised and meet:

- IEC 68-2-30 Damp heat
- IEC 68-2-2 Dry heat
- IEC 68-2-11 Salt mist
- IEC 68-2-1 Cold temperature withstand.

installation

The Compact CM is installed on a panel or on metal supports. It is fixed at 4 points accessible from the front, and located on the rear vertical plane. For control access through the door, two cut-outs can be envisaged:

- either to the control handle alone, with the position indicators and locking devices,
- or, in addition to the above parts, to the trip unit setting adjustments. The equipment can be supplied from upstream or downstream indifferently.

STCM trip unit

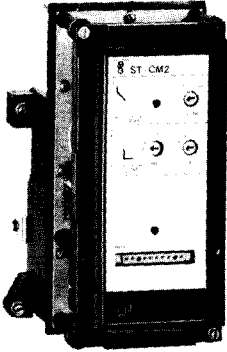

STCM2

The STCM is a solid state trip unit fitted to all the Compact CM circuit breakers. It is supplied by sensors built into the circuit breaker, and operates **without an auxiliary supply source**. The settings are accessible from the front. Three types of trip unit are available:

- **the STCM1** for protection against:
 - overloads (long time delay), adjustable.
 - short circuits (instantaneous), adjustable.
- **the STCM2** has a wider adjustment range than the STCM1. It offers the possibility of time **discrimination** and provides protection against:
 - overloads (long time delay), adjustable.
 - short circuits, adjustable threshold and time delay (short time delay).
 Discrimination is obtained on settings A, B, C and setting 0 gives instantaneous tripping.

- **the STCM3** carries out the same functions as the STCM2, with in addition a high threshold earth fault protection (greater than 500 A).

Protection testing

On the STCM2 and STCM3, a connector enables the user to check the processing unit by means of a multi-voltage test kit supplied as an option.

Fault indication

When tripping on a fault occurs, it is indicated in two ways:

- mechanically by the red SDE indicator,
- electrically by closing microswitch.

SDE operation

- local manual resetting: the SDE has to be pressed in to close the circuit breaker.
- automatic resetting: it is not necessary to press the SDE in to close the circuit breaker.

Selection of setting

The trip unit operating threshold can be adjusted as a function of the circuit breaker sensor current ratings **In** given below.

Compact CM	1250	1600	2000	2500	3200
Phase In	1250	1600	2000	2500	3200
Neutral In	630	800	1000	1250	–

Adjustment of the setting is carried out on all the poles simultaneously, including neutral for the four-pole Compact with protected neutral.

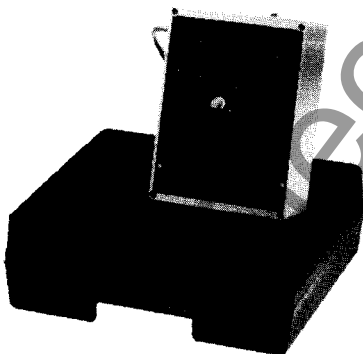

A portable test kit with connecting cables can be used to test the STCM2 or STCM3 type trip units.

The voltage supply to this test kit can be 110-127-220-240 V (50/60 Hz).

Compact CM presentation

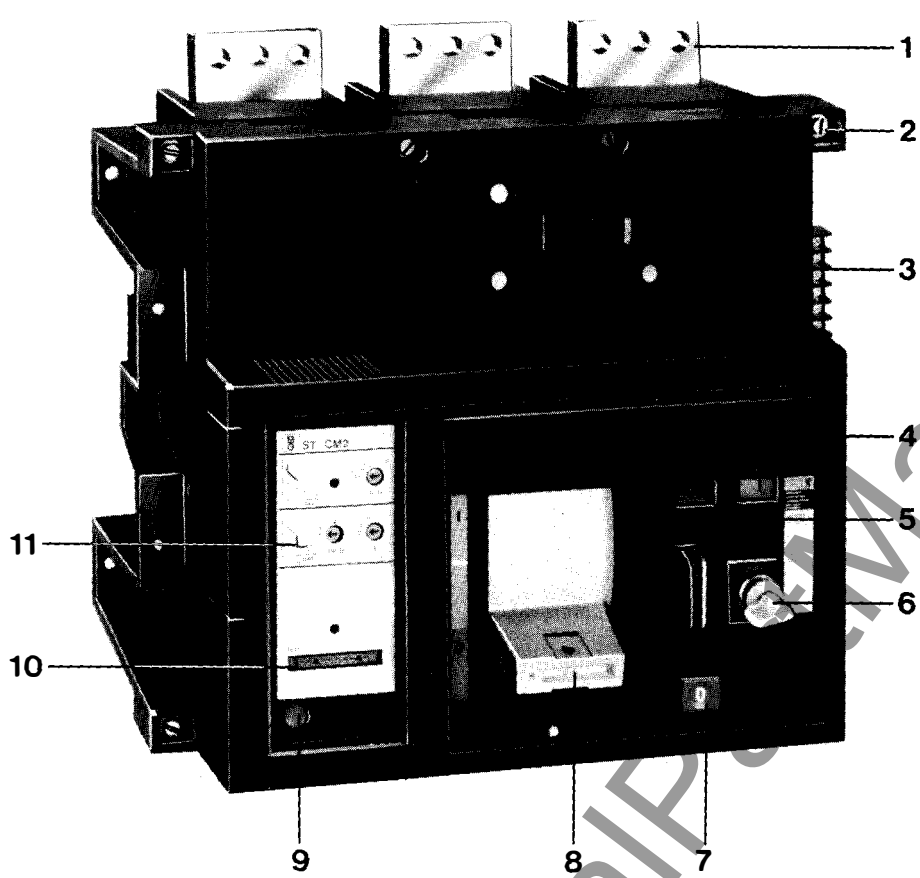

CM circuit breaker

- 1 terminal pad
- 2 cover fixing screw
- 3 auxiliary circuit connection terminal block
- 4 main and auxiliary contact position indicator
- 5 padlocking device
- 6 key-locking device
- 7 opening push-button
- 8 operating handle and position indicator
- 9 SDE: fault current trip indicator; the SDE is used for local resetting
- 10 test kit connector
- 11 long and short time delay protection with time delay setting adjustment.



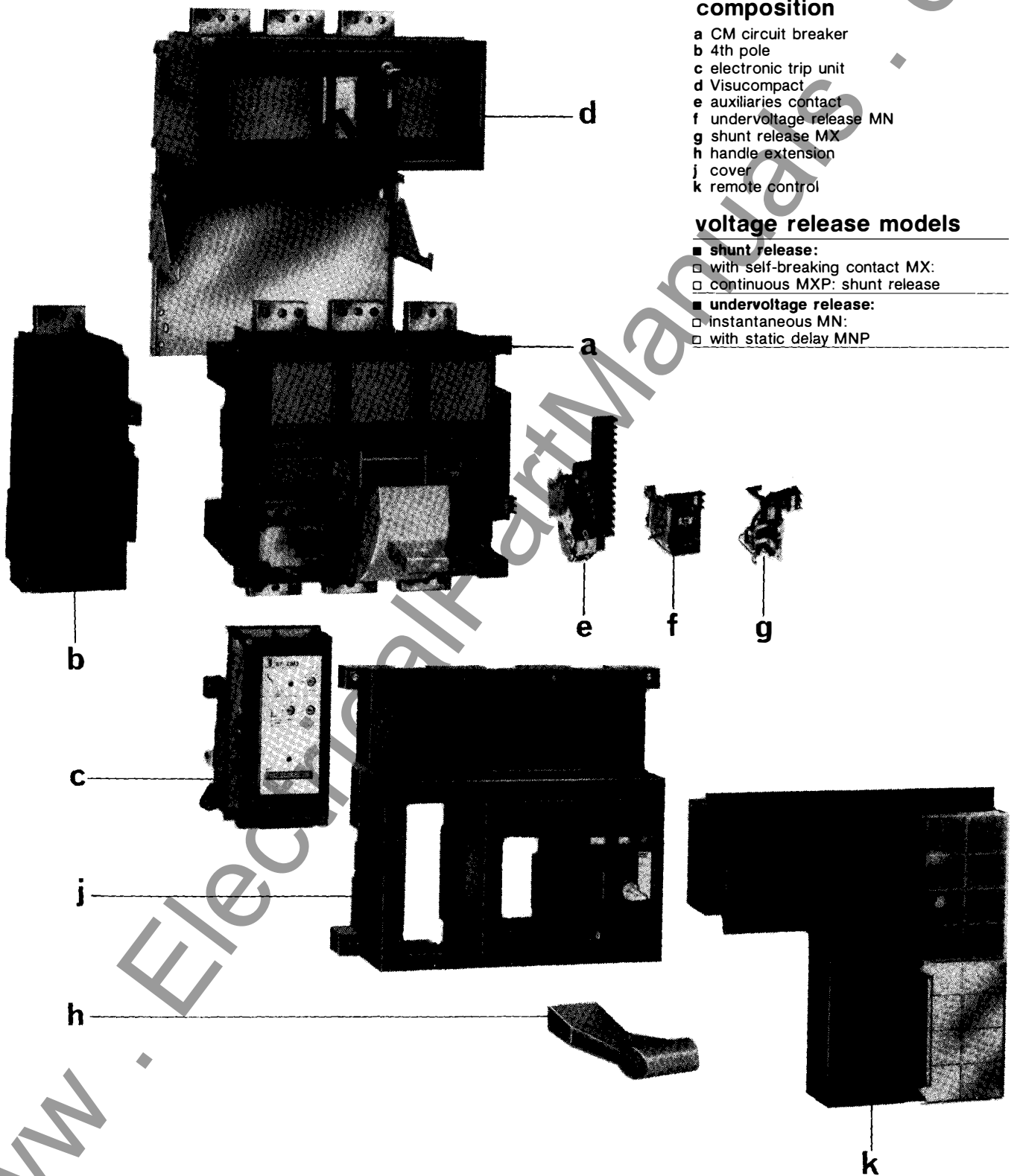

composition

- a CM circuit breaker
- b 4th pole
- c electronic trip unit
- d Visucompact
- e auxiliaries contact
- f undervoltage release MN
- g shunt release MX
- h handle extension
- j cover
- k remote control

voltage release models

- **shunt release:**
 - with self-breaking contact MX:
 - continuous MXP: shunt release
- **undervoltage release:**
 - instantaneous MN:
 - with static delay MNP

Compact CM electrical characteristics

Dimensions
Part numbers
Presentation

page 162
page 160
page 150

Compact		CM1250N	CM1250H	CM1600N	CM1600H	CM2000N	CM2000H	CM2500N	CM2500H	CM3200N	CM3200H	
rated current I_n (A)	40 °C	1250	1250	1600	1600	2000	2000	2500	2500	3200	3200	
	45 °C	1250	1250	1540	1540	1930	1930	2410	2410	3100	3100	
	50 °C	1250	1250	1470	1470	1840	1840	2310	2310	3000	3000	
	55 °C	1250	1250	1400	1400	1750	1750	2200	2200	2800	2800	
	60 °C	1250	1250	1330	1330	1660	1660	2075	2075	2700	2700	
rated insulation voltage U_i (V)		750										
rated operational voltage U_e (V)	AC 50/60 Hz	690										
	DC											
number of poles		3, 4	3, 4	3, 4	3, 4	3, 4	3, 4	3, 4	3, 4	3	3	
rated ultimate breaking capacity	220/240 V	85	125	85	125	85	125	85	125	85	125	
AC I_{cu} (kA rms) ⁽¹⁾ according to IEC 947-2 (P1 according to IEC 157-1) (1) defined for a power factor of : 0.5 if $6 < kA \text{ rms} \leq 10$ 0.3 if $10 < kA \text{ rms} \leq 20$ 0.25 if $20 < kA \text{ rms} \leq 50$ 0.2 if $kA \text{ rms} > 50$ (2) $L/R \leq 0.015 \text{ s}$	380/415 V	70	85	70	85	70	85	70	85	70	85	
	440 V	65	85	65	85	65	85	65	85	65	85	
	500 V	50	50	50	50	50	50	50	50	50	50	
	660/690 V	50	50	50	50	50	50	50	50	50	50	
	rated ultimate breaking capacity DC	$\leq 250 \text{ V}$										
I_{cu} (kA) according to IEC 947.2 ⁽²⁾	500 V											
rated service breaking capacity	% of I_{cu}	50 %										
utilisation category acc. to IEC 947-2		B										
rated short time	kA (rms)	32										
withstand current I_{cw} (kA)/ Δt	t (s)	1										
suitability for isolation in acc. with IEC 947-2		yes										
double case insulated front face		no										
rated impulse withstand voltage	U_{imp} kV	8										
pollution degree		III										
safety perimeter		see scheme on page 63										
Nema performances rated ultimate breaking capacity (0-C0) according to Nema AB1	240 V	85	125	85	125	85	125	85	125	85	125	
	480 V	65	85	65	85	65	85	65	85	65	85	
	600 V	50	50	50	50	50	50	50	50	50	50	
making capacity I_{cm} acc. to IEC 947-2 kA peak AC 50/60 Hz	380 V	150	187	150	187	150	187	150	187	150	187	
	440 V	110	187	110	187	110	187	110	187	110	187	
	500 V	110	110	110	110	110	110	110	110	110	110	
	600 V	110	110	110	110	110	110	110	110	110	110	
	660/690 V	110	110	110	110	110	110	110	110	110	110	
power loss three phase (W)	breaker	210	210	330	330	390	390	525	525	700	700	
	Visucompact	300	300	480	480	540	540	750	750			
maximum breaking time (ms)		50	50	50	50	50	50	50	50	50	50	
endurance mechanical		10 000	10 000	10 000	10 000	10 000	10 000	10 000	10 000	10 000	10 000	
electrical $I_n/690 \text{ V}$		2 000	2 000	2 000	2 000	2 000	2 000	2 000	2 000	2 000	2 000	
weight (kg)	3P	41	41	41	41	46	46	63	63	83	83	
	4P	56	56	56	56	61	61	78	78			
switch version electrodynamical withstand (kA peak) short time withstand I_{cs} (kA) weight (kg)	3P			65		65		65		65		
	4P			32		32		32		32		
	3P			37		42		59		79		
	4P			52		57		74				
Visucompact version weight (kg)	3P	64		64		73		92				
4P	86		86		95		114					
front face protection degree		IP 40										
solid state trip unit		STCM1			STCM2			STCM3				
mounting on Compact CM	3P	■								■ (3)		
	4P, unprotected neutral	■										
	4P, protected neutral											
long time delay protection	$I_r = I_n \times \dots$	0.5-0.6-0.7-0.8-0.9-1			0.5-0.6-0.7-0.8-0.9-1			0.5-0.6-0.7-0.8-0.9-1				
	tripping between:	1.05 and 1.25 I_r			1.05 and 1.25 I_r			1.05 and 1.25 I_r				
short time delay and instantaneous protection ⁽⁴⁾	$I_m = I_r \times \dots$	3-4-5-6			2-4-6-8			2-4-6-8				
	accuracy	$\pm 20 \%$			$\pm 15 \%$			$\pm 15 \%$				
	setting of time delay	none			0	A	B	C	0	A	B	C
	maximum resettable time (ms)	0			0	35	125	225	0	35	125	225
	maximum breaking time (ms)	50			50	120	220	330	50	120	220	330
	earth fault protection	$I_t = I_n \times \dots$	0.2-0.3-0.4-0.5									
accuracy		$\pm 15 \%$ ⁽⁵⁾										
setting of time delay		0 0.1 0.2 0.3										
maximum resettable time (ms)		0 135 235 345										
maximum breaking time (ms)		130 230 340 460										

(3) For systems with distributed but unswitched neutral, a 4th sensor can be supplied separately or fitting optional

Compact CM

Visucompact CM1250 to 2500

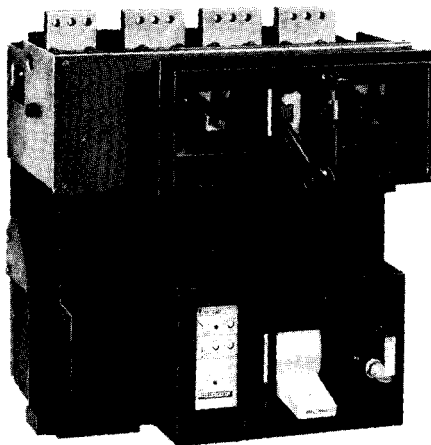

presentation

The Visucompact CM is a three or four-pole unit comprising:

- a disconnector for visible break disconnection.
- a fixed Compact CM circuit breaker for control and protection against overcurrents.

The disconnection function is carried out by high electro-dynamic withstand self-compensated finger contacts, which make the electrical connection by direct engagement on the upstream side of the circuit breaker.

The position of the contacts can be seen directly through a transparent screen.

A pretripping system prevents on-load disconnection. The disconnector is always fitted with an "open" position padlocking device for 3 padlocks (not supplied).

installation

The Visucompact CM is delivered in three separate elements:

- a disconnector mounted on a mounting plate
- a fixed Compact CM circuit breaker
- the fitting accessories.

The disconnector mounting plate is provided with guides to make circuit breaker installation easier.

The electrical connection between the two units being by means of the high-pressure finger contacts, the circuit breaker can easily be disconnected after the downstream connections have been removed.

characteristics

Disconnector characteristics are at least equivalent to those of circuit breakers on which they are used.

The Visucompact CM therefore offers the same performances as the Compact CM⁽³⁾.

Visucompact type	CM1250 to CM2500
rated voltage	660 V AC
number of poles	3 or 4

The other characteristics are identical to those of the Compact CM.

electrical auxiliaries, accessories and locking devices

All the Compact CM auxiliaries can be fitted to the Visucompact CM. Moreover the disconnector can accept:

- 1 unit of 2 auxiliary contacts⁽¹⁾.
- a device for locking in "open" position by Profalux B24-D4-Z key-lock (lock supplied)⁽²⁾.
- a door interlock (the door can only be opened if the disconnector is open).

Compact CM remote control

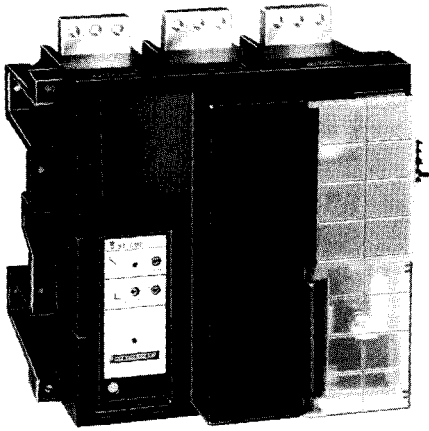

presentation

The remote control opens and closes the Compact CM from a distance on orders from push-buttons, changeover switches or relays.

It is fitted to the front face of the CM1250 and CM3200 circuit breakers and the Visucompact. Like the Compact CM, the remote control does not require any maintenance.

description

Equipped with a gear motor, the remote control ensures charging of operating mechanism and closing of the circuit breaker in the same cycle.

- **remote** opening is carried out by the MX shunt release or the MN or MNR undervoltage release.

- **local** opening is carried out by a pushbutton.

The state of the circuit breaker is given by an indicator:

- white: circuit breaker closed.
- green: circuit breaker open.

These two indicators give a positive break indication.

A handle fitted on the front face enables the circuit breaker to be operated locally. When local operation takes place, the remote electrical closing orders are locked.

installation

The remote control can be installed on the whole range of Compact CM circuit breakers having either a shunt trip unit (MX) or an undervoltage release unit (MN). It is fitted to the front of the circuit breaker⁽¹⁾.

use

- remote control and protection of circuits with a low operating rate;
- daily opening and closing of a circuit from a control desk;
- non-priority circuit load-shedding and restoring control.

electrical characteristics

Compact type	Compact CM1250 to CM3200								
supply voltage (A)	AC	50 Hz	48	110	127	220	240	380	415
		60 Hz	120	127	240	265	277	440	480
	DC	24	30	48	100	110	125	220	
consumption on closing	AC (all voltages)	VA	700						
	DC (all voltages)	W	700						
reponse time (under Un)	closing: T < 1.5 s								
	opening: circuit breaker opening time								
operating limits	voltage: 0.85 to 1.1 Un at 40 °C								
endurance CO cycles (IEC)	10 000								
max operating rate	2 cycles per minute								
fault contact (SDE)	■								

Compact CM electrical auxiliaries and accessories

installation of auxiliaries

Auxiliaries can be easily fitted without adjustment by means of 2 fixing screws. Each auxiliary unit has a precabled connection terminal (except the SDE

contact which has to be wired to 2 separate terminals supplied). This terminal is accessible from the front without removing the cover.

auxiliary contacts

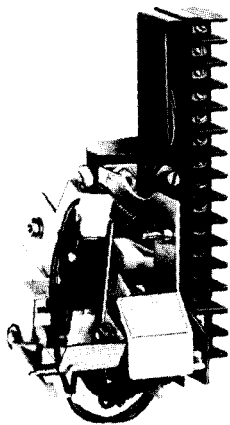

4 OF + SD unit

- 1 unit including 2 OF contacts of changeover type with common point to indicate open or closed;
- 1 unit including 4 OF contacts of changeover type with common point to indicate open or closed, associated with an SD contact of changeover type with common point which indicates the circuit breaker discharged position following tripping either by the static trip unit or by the voltage release units;
- 1 SDE contact (electrical fault signal), a closing contact which indicates circuit breaker discharged position following tripping by the static trip unit only. This contact cannot be fitted in Compact CM load break switches.

Fitting possibilities

In addition to the voltage release, each circuit breaker can accept auxiliary contacts in the combinations given below:

OF	SD	SDE
2		1
4	1	1
4		1

Electrical characteristics

auxiliaries type	OF	SD	SDE
rated current (A)	2	2	2
breaking capacity	AC 240 V	6	5
	480 V	6	5
	600 V	3	3
DC	24 V	3	3
	48 V	3	3
	125 V	0.5	0.5
	250 V	0.25	0.25

voltage releases

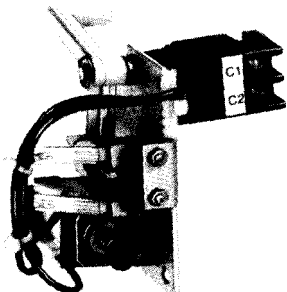

Shunt trip unit (MX)

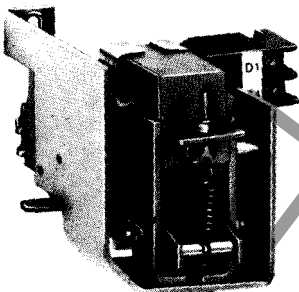

Undervoltage release unit (MN)

Fitting possibilities

Whatever the type of Compact CM, its rating and the number of poles, only one voltage release can be fitted per circuit breaker, either:

- an undervoltage release
- instantaneous (MN),

□ delayed action by static time delay (MNR);

- or a shunt trip
- with self-breaking contact (MX),
- continuous (MXP); a derivative of the MX trip unit, it can remain continuously under voltage to prevent closing.

Electrical characteristics

supply voltage	see page 161	
undervoltage release unit	operation between 0.35 and 0.7 Un	
instantaneous (MN)	consumption (all voltages) inrush	hold
time delayed (MNR)	AC (VA) 200	80
	DC (W) 45	3
	opening time 50 ms	
shunt trip unit	accessories: static time delay set from 0.5 to 1 s	
self-breaking (MX)	operation between 0.7 and 1.1 Un	
	consumption (all voltages) inrush	
	AC (VA) 110	
	DC (W) 120	
	opening time 50 ms	
shunt trip unit	operation between 0.7 and 1.1 Un	
continuous (MXP) ⁽¹⁾	consumption (all voltages) inrush	hold
	AC (VA) 200	80
	DC (W) 45	3
	opening time 50 ms	

⁽¹⁾ a derivative of the MN trip unit, it can remain continuously under voltage while preventing closing.

locking devices

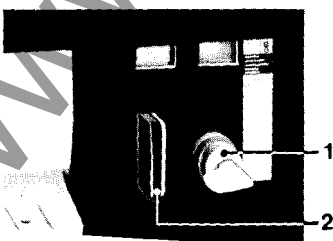

On illustration opposite:
1 - key-lock
2 - padlock device

The following locking devices can be supplied on request:

- open position padlocking device (padlock not supplied).
 - a device for locking in open position by Profalux KS5B24 key-lock supplied, key shape identical to Profalux V11-18.
- On request, Ronis N2070 type lock, key shape identical to Ronis 1104 or EL11AP.

Compact CM wiring diagrams

wiring diagram with: remote control

right-hand terminal block

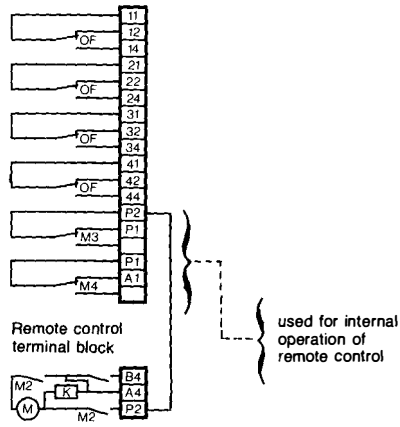

manual control

right-hand terminal block

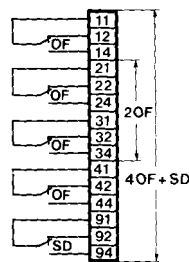

Voltage releases

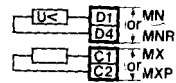

- XR** connection terminals
- K** self-supply relay
- MX** shunt release with self-breaking contact
- MN** undervoltage release
- MXP** continuous shunt release
- M** electrical operating mechanism motor
- M2** cover opening interlock
- QF** CM circuit breaker
- BPO** opening pushbutton
- YS** fault trip lock-out and reset
- SDE** fault trip indication
- XR** connection terminals
- R** additional resistance for U > 220 V AC or DC

diagram no. 698596 for local manual reset

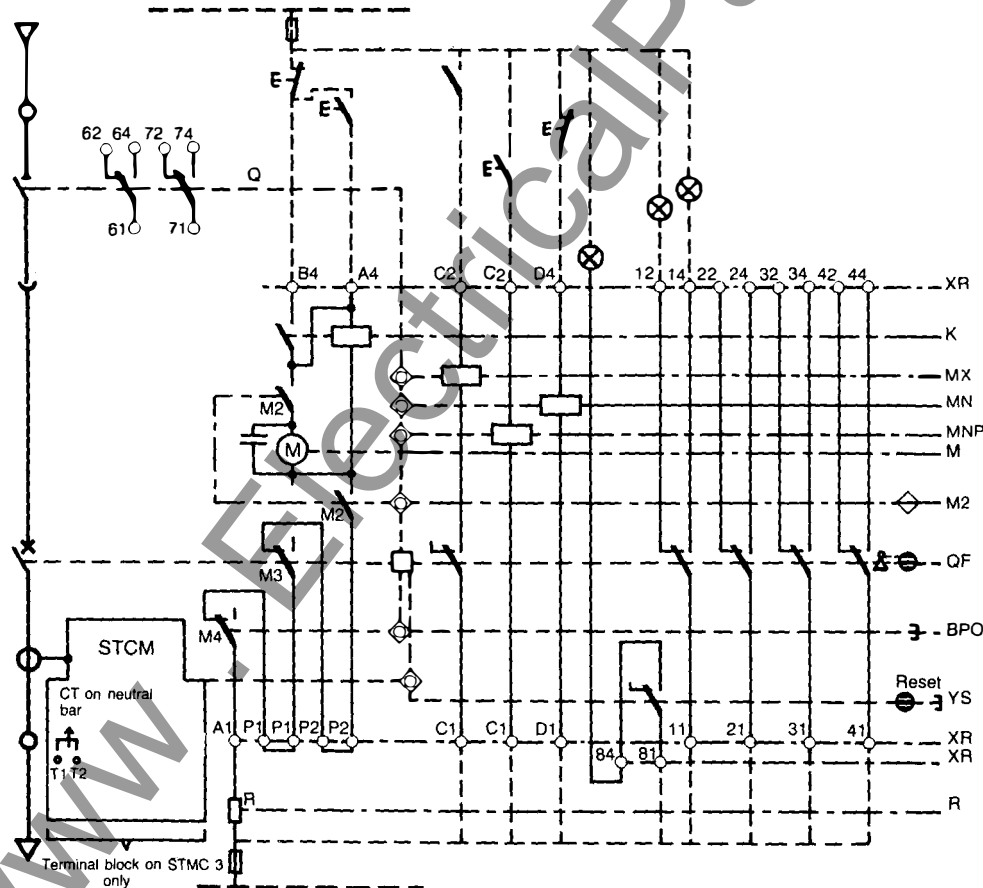

Compact CM connection

Compact CM connection

For the 1250, 1600 and 2000 A ratings, the equipment is supplied with bare terminals. A set of orientable connectors can be supplied as an option. The bars can then be fitted in all the usual directions.

For the 2500 A rating, the circuit breaker is always supplied with a set of orientable connectors on the middle phase. **These connectors must be used to connect the bars.** However, the neutral and outside terminals are supplied bare. Sets of connectors can be supplied for these terminals as an optional extra.

For the 3200 A rating, the basic circuit breaker includes connectors enabling connection to be made by means of horizontal edgewise bars.

1250-1600-2000 A ratings

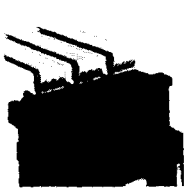

Horizontal or vertical flat bars on bare terminals.

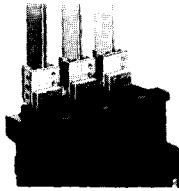

Horizontal or vertical edgewise bars with connectors.

2500 A rating

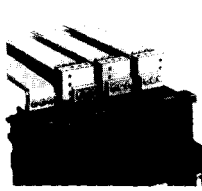

Horizontal flat bars with connectors.

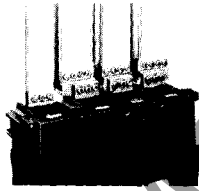

Vertical edgewise bars with connectors.

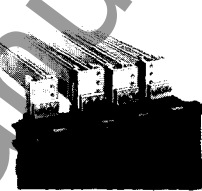

Horizontal edgewise bars with connectors.

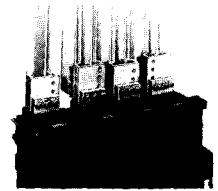

Vertical edgewise bars with connectors.

3200 A rating

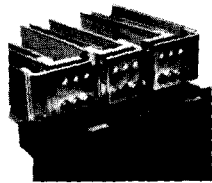

Horizontal edgewise bars with connectors.

Visucompact CM connection

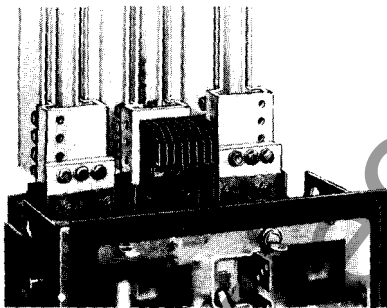





The method of connection to the (upstream) disconnector terminals is the same as for the Compact CM. Only the distance between fixing centres and the dimensions of the terminal differ (see overall dimensions).

The connectors are the same as for the Compact CM, and the bar orientation and arrangement possibilities are the same. As for the Compact CM, **the 2500 A rating must be connected by means of the connectors supplied with the equipment.**





Compact CM CM1600 to CM3200

Compact CM mccb's Visucompact CM Compact CM type I switches





Compact CM

		trip unit	3P 3t	4P 3t	4t	3t + N/2	4th earth fault protection sensor (fitted outside the circuit breaker, with STCM3 only)
Compact CM1250	fixed FC		STCM1	55400	55406		
			STCM2	55411	55417	55422	
			STCM3	55427			1250 A
Compact CM1600	fixed FC		STCM1	55401	55407		
			STCM2	55412	55418	55423	
			STCM3	55428			1600 A
Compact CM2000	fixed FC		STCM1	55402	55408		
			STCM2	55413	55419	55424	
			STCM3	55429			2000 A
Compact CM2500	fixed FC		STCM1	55403	55409		
			STCM2	55414	55420	55425	
			STCM3	55430			2500 A
Compact CM3200	fixed FC		STCM1	55405			
			STCM2	55416			

Compact CM type H

		trip unit	3P 3t	4P 3t	4t	3t + N/2	4th earth fault protection sensor (fitted outside the circuit breaker, with STCM3 only)
Compact CM1250H	fixed FC		STCM1	55433	55439		
			STCM2	55444	55450	55455	
			STCM3	55460			1250 A
Compact CM1600H	fixed FC		STCM1	55434	55440		
			STCM2	55445	55451	55456	
			STCM3	55461			1600 A
Compact CM2000H	fixed FC		STCM1	55435	55441		
			STCM2	55446	55452	55457	
			STCM3	55462			2000 A
Compact CM2500H	fixed FC		STCM1	55436	55442		
			STCM2	55447	55453	55458	
			STCM3	55463			2500 A
Compact CM3200H	fixed FC		STCM1	55438			
			STCM2	55449			

Visucompact CM

		trip unit	3P 3t	4P 3t	4t	3t + N/2	4th earth fault protection sensor (fitted outside the circuit breaker, with STCM3 only)
Visucompact CM1250	fixed FC		STCM1	55466	55470		
			STCM2	55474	55478	55482	
			STCM3	55486			1250 A
Visucompact CM1600	fixed FC		STCM1	55467	55471		
			STCM2	55475	55479	55483	
			STCM3	55487			1600 A
Visucompact CM2000	fixed FC		STCM1	55468	55472		
			STCM2	55476	55480	55484	
			STCM3	55488			2000 A
Visucompact CM2500	fixed FC		STCM1	55469	55473		
			STCM2	55477	55481	55485	
			STCM3	55489			2500 A

Compact CM switches

		rating (A)	3P	4P
Compact CM1600I	fixed FC	1600	55490	55494
Compact CM2000I	fixed FC	2000	55491	55495
Compact CM2500I	fixed FC	2500	55492	55496
Compact CM3200I	fixed FC	3200	55493	

electrical auxiliaries

auxiliary switches



for Compact CM	
2 OF	55541
4 OF + 1 SD	55542
for Visucompact CM	
2 OF	55543
for remote control	
4 OF (supplied with remote control)	55676

voltage releases (for remote tripping)



MX (shunt trip)			
AC 50 Hz (V)		AC 60 Hz (V)	
48	55546	120/127	55547
110/127	55547	240/265	55548
208/220	55548	440/480	55550
/240			
380/415	55549	440	55550

DC (V)			
24	55544		
30	55545		
48	55546		
110/125	55547		
220	55548		

MXP (continuous current shunt trip)

AC 50 Hz (V)		AC 60 Hz (V)	
48	55693	120	55592
110	55586	127	55586
127	55587	240	55593
220	55588	265	55588
240	55589	277	55594
380/415	55591	440	55595
		480	55591

DC (V)	
24	55597
30	55598
48	55599
60	55697
110	55600
125	55601
220	55602



MN (instantaneous undervoltage release)

AC 50 Hz (V)		AC 60 Hz (V)	
48	55681	120	55558
110	55552	127	55552
127	55553	240	55559
220	55554	265	55554
240	55555	277	55560
380/415	55557	440	55561
		480	55557

DC (V)	
24	55563
30	55564
48	55565
60	55685
110	55566
125	55567
220	55568



MNR (time delayed undervoltage release)

AC 50 Hz (V)		AC 60 Hz (V)	
48	55687	120/127	55570
110	55569	240	55572
120/127	55570	440	55578
208/220	55571		
240	55572		
380	55573		
415	55574		

DC (V)			
24	55580		
30	55581		
48	55582		
110	55583		
125	55584		
220	55585		

adaptable motor mechanism (1)



AC 50 Hz (V)		AC 60 Hz (V)	
48	55603	120/127	55611
110	55604	240	55613
127	55605	265	55614
220/240	55607	277	55615
380	55609	440	55616
415	55610	480	55617

DC (V)			
24/30	55618		
48	55620		
60	55621		
100	55622		
110	55623		
125	55624		
220	55625		

accessories

locking by padlocks or key lock



for Compact CM	
for 3 padlocks (not supplied)	55653
for 3 padlocks (not supplied) + 1 Profalux B24D4Z	55654
for 3 padlocks (not supplied) + 1 Ronis type 1351B	55655
for Visucompact CM	
on disconnector ⁽²⁾	
for 3 padlocks (not supplied)	55656
1 Profalux B24D4Z	55657
1 Ronis type 1351B	55658
1 door lock	55659

sealing accessory

transparent sealable shield for Statipact STCM trip units	55652
--	-------

dummy trip unit (supplied with Compact CM switch)

for Compact CM switch 1250 to 3200 A	55535
---	-------

testing kit



for trip unit STCM2 and STCM3 (110-127-220-240 V AC)	55651
---	-------

connection

for Compact CM and Visucompact CM



phase or neutral connector for Compact CM ≤2000 A or neutral connector for Compact CM ≤2500 A	
1 connector	55660
4 connectors for CM 2500 poles 1 and 3	55377

spare parts

for compact CM

toggle handle	55661
extension handle	55662
cover for 3P breaker	55663
cover for neutral pole	55664
shield for auxiliaries	55665

for Visucompact CM

operating handle	55668
front bezel 3 or 4P	55669

for motor mechanism

cover	55670
toggle handle	55671
safety handle	55672

connectors for CM2500 N/H ST

right up or left down	55673
left up or right down	55674
central up or down	55675

Visucompact CM1250 to 2500

Approximative weights (kg)
without accessories or auxiliaries

rating	1250	1600	2000	2500
3-pole	64	64	73	92
4-pole	86	86	95	114

Upstream terminal pads

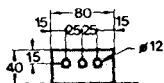

rating	a	b
≤ 1600	120	150
2000	130	140
2500	130	140

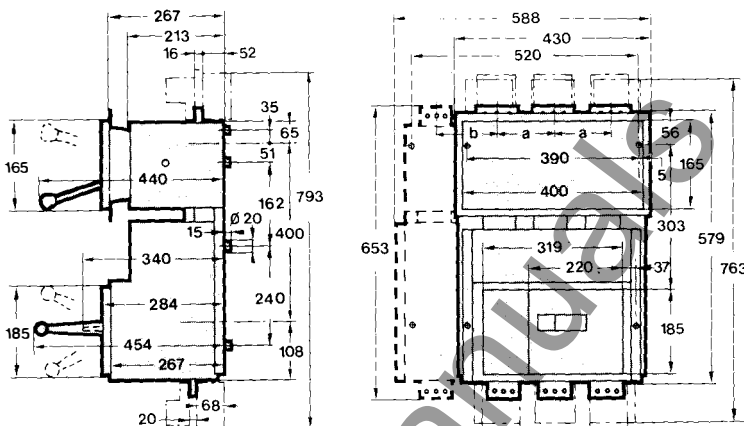

Upstream connection

The downstream connection is identical to the Compact CM (see opposite).
Visucompact CM1250 to 2000⁽¹⁾ Visucompact CM2500⁽²⁾

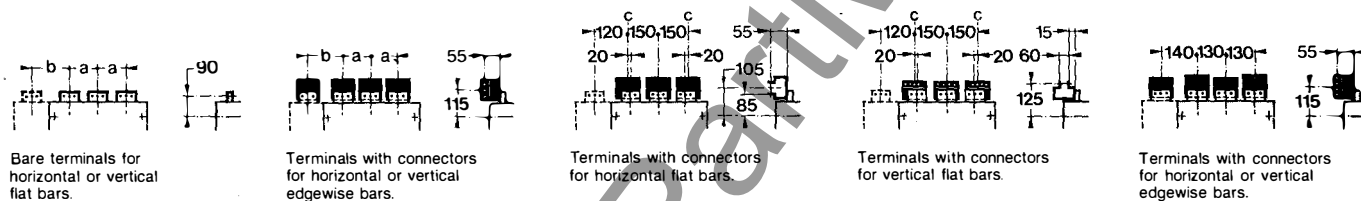

C: busbar fixing axis

remote control for Compact CM1250 to 3200

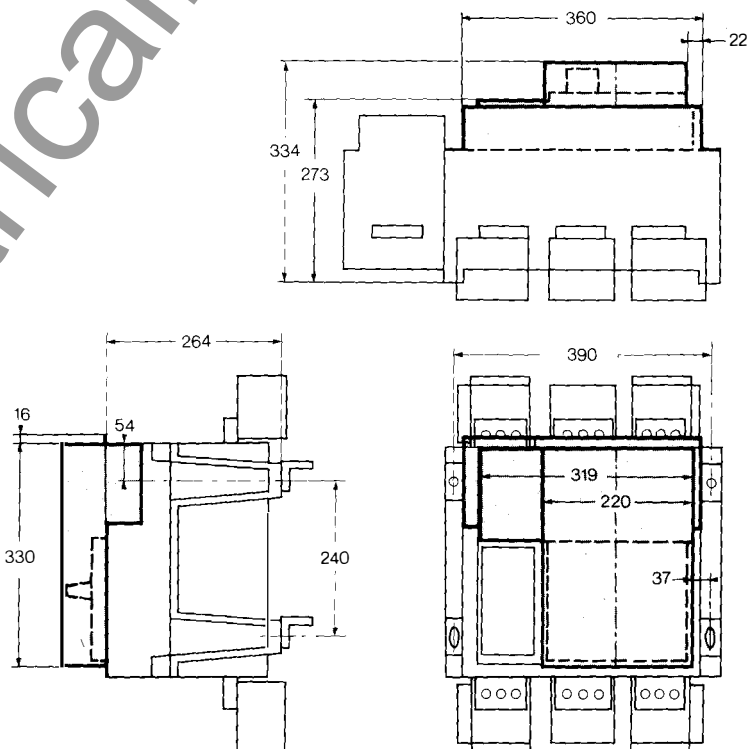

Compact CM tripping curves

STCM1

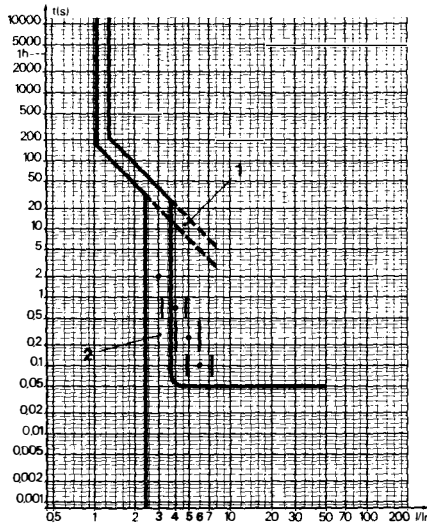

- (1) long time delay protection (overloads).
- (2) instantaneous protection (short circuits).

STCM2 and STCM3

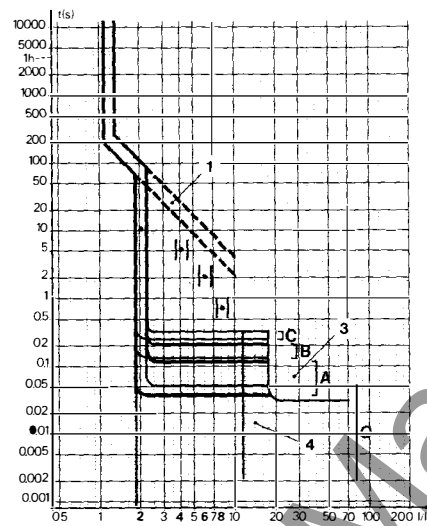

- (3) short time delay protection (short circuits), with time delay settings.
- (4) instantaneous 35 kA (shown for the 2500 A rating).

STCM3: earth protection

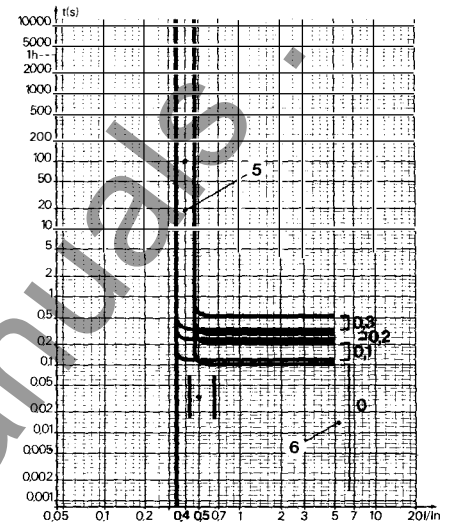

- (5) earth fault protection.
- (6) time delay settings for earth protection.



www.ElectricalPartManuals.com

www.ElectricalPartManuals.com





www.ElectricalPartManuals.com

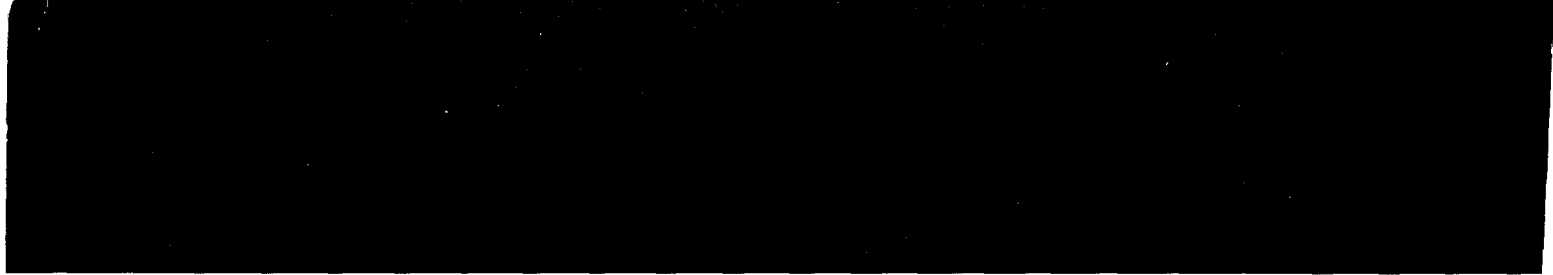

www.ElectricalPartManuals.com

www.ElectricalPartManuals.com