

INSTRUCTION MANUAL

For

5

PULSAR[®] Universal Test System

The PULSAR test set includes a ROM-resident computer program. This program belongs to AVO Multi-Amp Corporation and contains trade secret ideas and information of AVO Multi-Amp Corporation.

To the extent this program contains ideas, AVO Multi-Amp Corporation intends to protect and enforce its rights under state law. To the extent the program is deemed to constitute a form of expression of idea, AVO Multi-Amp Corporation intends to protect and enforce its rights under the Copyright Act of 1976. The Statutory Copyright notice has been affixed hereto in the event that it is later determined that the program has been published within the meaning of the Copyright Act of 1976.

It is essential that this instruction book be read thoroughly before putting the equipment in service.

REVISION HISTORY

<u>Revision</u>	<u>ECN #</u>	<u>Date</u>
1	00000	09/28/93
2	25566	10/07/93
3	25614	10/29/93
4	25858	03/30/94
5	25969	06/28/94
6	26039	08/16/94
7	26062	09/06/94
8	26920	06/24/96
9	28156	08/26/98
10	28688	11/11/99

APPRECIATION

We are indebted to the manufacturers of protective relays, who have given their time and advice in the preparation of this instruction book.

And, we also express our gratitude to engineers and technicians all over the country for their counsel and suggestions towards the testing and maintenance of protective relays.

IMPORTANT

The information and data contained within this instruction manual are proprietary with AVO MULTI-AMP Corporation. The equipment described herein may be protected by one or more U.S. letters patent. AVO MULTI-AMP specifically reserves to itself all rights to such proprietary information as well as all rights under any such patent, none of which is waived by the submission of this instruction manual to anyone.











The recipient, if a Government agency, acknowledges that this instruction book and the equipment described were procured with "Limited Rights" to technical data as described in ASPR 9-203 (b).

Copyright AVO MULTI-AMP Corporation, 1992, 1993, 1994, 1996, 1998

SAFETY PRECAUTIONS

WARNING: VOLTAGES GENERATED BY THIS INSTRUMENT CAN BE HAZARDOUS

This instrument has been designed for operator safety; however, no design can completely protect against incorrect use. Electrical circuits are dangerous and can be lethal when lack of caution and poor safety practices are used. There are several standard safety precautions that should be taken by the operator. Where applicable, IEC safety markings have been placed on the instrument to notify the operator to refer to the instruction manual for instructions on correct use or safety related topics. Refer to the following table of symbols and definitions.

Symbol	Description
	Direct Current
	Alternating Current
	Both direct and alternating current
	Earth (ground) Terminal. The PULSAR output modules Ground terminals are connected to chassis ground. There is a common chassis ground terminal located on the back panel (see Back Panel under Description of Controls).
	Protective Conductor Terminal
	Frame or Chassis Terminal
	On (Supply)
	Off (Supply)
	Caution, risk of electric shock
	Caution (refer to accompanying documents)

UNDER NO CIRCUMSTANCES SHOULD THE OPERATOR OR TECHNICIAN ATTEMPT TO OPEN OR SERVICE THIS INSTRUMENT WHILE CONNECTED TO A POWER SOURCE. LETHAL VOLTAGES ARE PRESENT AND MAY CAUSE SERIOUS INJURY OR DEATH!

SAFETY PRECAUTIONS CONTINUED

The following are some specific safety related items associated with the PULSAR test system.

Always start with the power OFF, before connecting the power cord. Make sure outputs are off before attempting to make test connections.

Always use properly insulated test leads. The test leads supplied with the unit are rated for the continuous output ratings of the test system, and should be properly used and cared for. Do not use cracked or broken test leads.

Be careful when using the DC Battery Simulator. The DC is on continuously when the power to the test system is on. Make test connections to the device under test prior to connecting the DC Battery Simulator.

Always turn the test system off before disconnecting the power cord or removing / inserting output modules. If removing or inserting modules (output modules, timer modules, etc.) turn unit off, wait several minutes and disconnect the power cord from the test system before removing any module. This allows internal power supply charging voltages to dissipate.

DO NOT power up without module mounting screws and rear thumb screws secured.



UNDER NO CIRCUMSTANCES SHOULD THE OPERATOR PUT HIS HANDS OR TOOLS INSIDE THE TEST SYSTEM CHASSIS, OR BACK PLANE AREA, WITH THE TEST SYSTEM CONNECTED TO A POWER SOURCE AND TURNED ON. LETHAL VOLTAGES ARE PRESENT AND MAY CAUSE SERIOUS INJURY OR DEATH!

TABLE OF CONTENTS

I. THEORY OF OPERATION1	1
A. DESCRIPTION OF CONTROLS	1
1.1 Terminology.....	1
1.2 Input Power And Control Module.....	3
1.3 Timer-Monitor And Battery Simulator Module	14
1.4 Voltage Generator Module	18
1.5 Current Generator Module	18
1.6 High Current Interface Module	19
1.7 Back Panel	21
B. INITIAL SET-UP	22
C. OPERATING PROCEDURES	23
1.0 Setting Phase Angle Relationships	23
1.1 Current Sources-Parallel Operation	24
1.2 Current Sources-Harmonic Restraint Test	25
1.3 Voltage Sources - Outputs Summed Together.....	27
1.4 Voltage Sources - Dynamic Voltage Relay Test.....	27
1.5 Voltage Sources - 3Ø, 3-Wire, Open-Delta and T-Connection.....	27
1.6 Voltage Source - 3Ø, 4-Wire, Y-Connection.....	30
1.7 Manual example for setting up a 3-phase WYE relay test.....	34
1.8 Testing Sync-Check, Synchronizing and Auto-Synchronizing Relays	35
1.9 Testing Frequency Relays.....	36
2.0 Testing DC Target And Seal-In	38
D. SERVICE DATA	39
1.1 Servicing	39
1.2 Service and Repair Order Instructions	39
1.3 Preparation for Reshipment	40
E. WARRANTY STATEMENT	41
F. REPAIR DATA	41
1.1 Basic Troubleshooting.....	42
1.2 Power Input.....	42
1.3 Input Power and Control Module.....	43
1.4 Timer, Monitor and Battery Simulator Module	44
1.5 Voltage Amplifier Module	46
1.6 Current Amplifier Module.....	47
II. TESTING PROCEDURES	48
Testing of Westinghouse Type AR Relay.....	48
Testing of General Electric Type BDD 15 & 16 Relays	50
Testing of Basler Type BE1-81 O/U Relay	60
Testing of General Electric Type CEB Relay.....	64
Testing of General Electric Type CEY Relay.....	68
Testing of Westinghouse Type CF-1 Relay.....	72
Testing of General Electric Type CHC11 Relay	76
Testing of Westinghouse Type CO Relay	79
Testing of Westinghouse Type CRN-1 Relay.....	82

TABLE OF CONTENTS Continued

Testing of Westinghouse Type CV Relay.....	86
Testing of Westinghouse Type CVE Relay	88
Testing of General Electric Type GCX Relay	92
Testing of General Electric Type GCY Relay	98
Testing of General Electric Type GGP Relay	102
Testing of Westinghouse Type HU and HU-1 Relays.....	106
Testing of General Electric Type IAC Relays	118
Testing of General Electric Type IAV Relay	122
Testing of General Electric Type IJF Relay	125
Testing of General Electric Type IJS Relay	128
Testing of Westinghouse Type IRD and IRV Relays.....	132
Testing of General Electric Type JBC and JBCV Relays	136
Testing of General Electric Type JBCG51 Relay	140
Testing of Westinghouse Type KA Relay	143
Testing of Westinghouse Type KC Relay.....	146
Testing of Westinghouse Type KD Relay.....	149
Testing of General Electric type IFCV Relay	156
Testing of Westinghouse Type KLF Relay	160
Testing of General Electric Type PJC Relay	165
Testing of General Electric Type PJV Relay	169
Testing of Basler Type PRS-170 Relay	173
Testing of General Electric Type PVD Relay.....	178

- III. **APPENDIX A: Remote Operation Command Set**
- IV. **APPENDIX B: PULSAR Error Codes**
- V. **APPENDIX C: PULSAR Product Specifications**

I. THEORY OF OPERATION

A. DESCRIPTION OF CONTROLS

This section of the instruction manual describes the function of all the various controls, switches, push-buttons or keys, alpha-numeric keys, binding posts etc., which are located on the front panel of the AVO Multi-Amp's PULSAR® Universal Test System. All controls and outputs are clearly marked and logically grouped so that continual reference to the instruction manual should not be necessary after the operator has become acquainted with the operation of the test system.

Since the PULSAR design is based on a "modular" concept, the front panel of a PULSAR may vary from unit to unit depending on the modules selected. There are many unique modules or sections a PULSAR may have; Input Power and Control Module, Timer/Monitor and Battery Simulator Module, Voltage Generator Module, Current Generator Module, High Current Interface Module and Blank Module.

Every PULSAR must have the Input Power and Control Module. For testing a relay or for monitoring the response of a device, the Timer/Monitor and Battery Simulator Module is (mandatory) a must. There may be one or more Voltage or Current Modules as required.

1.1 Terminology

There are a few terms and definitions that will be used throughout this manual. A brief description follows.

1.1.1 Procedure

A sequence of front panel key depressions pertaining to the execution of a specific function will be collectively called a procedure.

1.1.2 Procedure Diagram

A procedure diagram is a diagram that is used to explain the correct sequence and content for entering front panel keys for a single function to the PULSAR unit. Such diagrams contain boxes, lines, text, and sometimes arrows.

Horizontal lines without an arrow pointing left that connect boxes (or that connect other lines which eventually connect boxes) indicate logic flow from left to right. Presence of an arrow pointing left indicates logic flow opposite to the default direction.

If a vertical line connects to a line with a left arrow, that vertical line indicates a permissible logic choice only in the direction of that arrow. Other vertical lines that have multiple choices toward the right indicate that each of the choices to the right is logically permissible.

1.1.3 Button Or Key Constants

The contents of certain boxes within procedure diagrams are key constants. A key constant is a set of capital letters and represents a front panel key (except up and down arrow keys, digits, the colon, and the decimal point).

1.1.4 Procedure Variables

A procedure variable is a set of lower case letters that occurs within a box in a procedure diagram. The form and function of each procedure variable is defined in each procedure.

1.1.5 Terminator

A terminator is a final box in a procedure diagram for the front panel of the PULSAR unit. The two valid terminators are the key constant EX (the execute key) and the empty box.



The empty box indicates that the user intends to enter another procedure (function) following this one, and that the user wants this procedure to be executed at virtually the same time as the next procedure. Procedures ending with an empty box are stored until a procedure ending with EXECUTE is received. This allows the cancellation of the effect of a human entry time delay between each pair of procedures in a lengthy string of procedures. All procedures between EXECUTE key depressions will be executed nearly simultaneously. **The empty box is merely a convenience in a procedure diagram; it does not correspond to any key depression.**



A procedure (or string of procedures separated by empty boxes) which ends with an EXECUTE terminator will be executed as soon as it can be processed.

1.1.6 Multiple Choice Symbol

The vertical symbol below is the multiple choice beginning symbol. This shows the starting point for a procedure diagram which has more than one choice for a starting procedure constant.



1.1.7 Shift Key

The numeric keypad area contains two possible functions for each key. The digit usage of these keys is accomplished in a normal fashion. The other (miscellaneous) usage requires, that prior to depressing the target key at its lettered description, one must first depress the Shift key. This Shift key must be released prior to depressing the target key. The Shift key's effect only lasts for the next one keystroke. If that next keystroke is not a key in the numeric keypad area, the prior depression of the Shift key is ignored.

1.2 Input Power And Control Module

This module will always be located at the top-left corner of the unit. As mentioned earlier this module is vital to PULSAR operation. This module may be divided into two sections: Power On section (left half) which is devoted to the power on and reset operation of the unit; and the Control section (right half) which allows manual selection of voltage and/or current generator, selection and setting of AC/DC parameters, selection of phase, frequency and range, timer start/stop controls, selection of SYNC parameters, selection of waveforms, outputs on/off etc. A description of each available switch and its operation is described below:

POWER ON/OFF Switch

Vertically located in the Power On section of the module, labeled **1/0**, this switch energizes a PULSAR unit ("1" = ON and "0" = OFF).

RESET Switch

Located right below the POWER ON/OFF switch, resets the unit to its power-up state without having to power down the entire unit. Use a pencil or a pen to reach and execute. A typical situation when a RESET operation may be required is when there is a "communication lock-up" between a Personal Computer and PULSAR.

CONTROL SECTION

The right half of the module is called the **Control** section. It can be divided into five individual menus which offer the following features:

SELECT/GENERATOR:

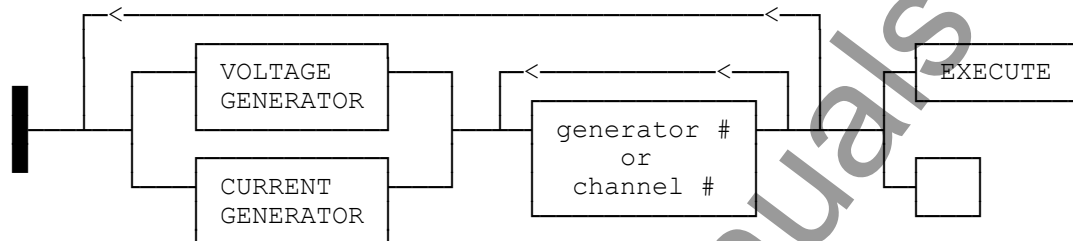

where,

VOLTAGE - denotes the **VOLTAGE** key and indicates that a voltage generator is being selected.

CURRENT - denotes the **CURRENT** key and indicates that a current generator is being selected.

generator # or channel # - a single digit in the range of 0 to 9 indicating the generator to be included in this selection.

0 (zero) is pre-defined to mean all generators of the same type e.g., **V, 0** selects all voltage generators.

NOTE: In this example and in the subsequent examples comma (',') is a separator. It is neither a command nor a part of the command sequence.

Example: **VOLTAGE, 0, EXECUTE**. This sequence of key strokes would select all available voltage generators.

Located at the top of the Control section, this menu incorporates two keys labeled **VOLTAGE** and **CURRENT** which, along with the key labeled **EXECUTE** (located at the bottom of the Control section under the "**OUTPUTS**" menu), select a group of voltage and/or current generators which will be acted upon by other options on the Control section. This selection remains effective until the next selection is made or until a unit **RESET** is executed.

All voltage generators may be freely interchanged among the slots of PULSAR unit without manually adjusting anything in these generators. The same is true

for current generators. The PULSAR unit assigns numbers for identification to the voltage and current generators as follows.

From left to right, top to bottom, the left-most voltage generator is voltage generator number 1. Each successively higher numbered voltage generator is physically positioned to the right of the prior ones. The same scheme applies to the current generators. The left-most generator will either be voltage generator 1 or current generator 1. Voltage and current generators may be interspersed among each other. There may be one or more empty slots between two filled generator slots.

One advantage of this procedure is that either of the keys labeled **"GENERATOR/VOLTAGE"** or **"GENERATOR/CURRENT"** may be keyed immediately after the other one to cancel the effect of the previous key and assert the new one e.g., **"VOLTAGE, CURRENT, 1, EXECUTE"** would select current generator 1 since no number was entered for the voltage generator. Another example - **VOLTAGE, 2, CURRENT, 1, EXECUTE** would select current generator 1 and voltage generator 2. No error beep or flash will accompany such a change.

Example: **"VOLTAGE, 1, CURRENT, 2, VOLTAGE, 3, EXECUTE"**. This sequence of key strokes selects voltage generators 1 and 3 and current generator 2. This could have been entered with **"VOLTAGE, 1, 3, CURRENT, 2, EXECUTE"**.

SETTING/AMPLITUDE:

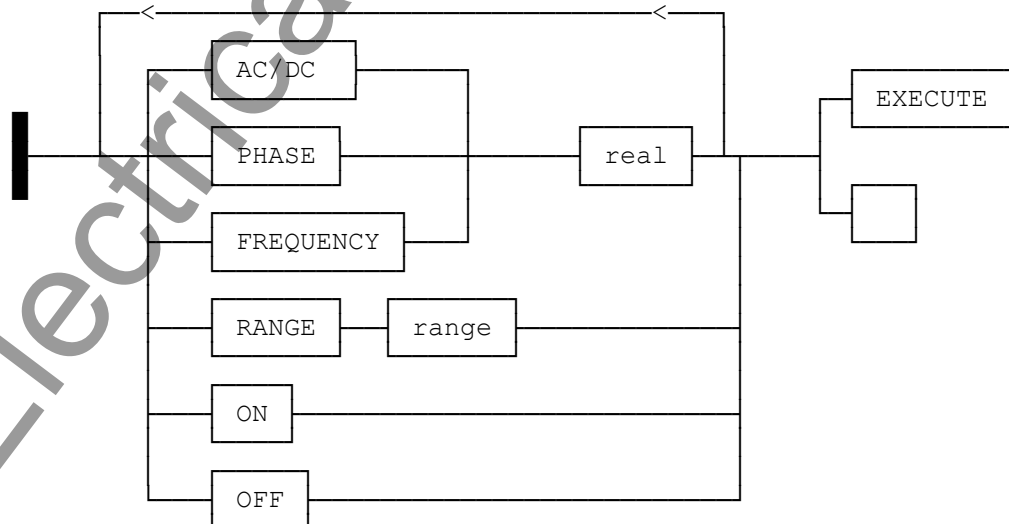

Located right below the **SELECT/GENERATOR** menu is the

SETTING/AMPLITUDE menu. This menu has six keys labeled **AC**, **DC**, **PHASE**, **FREQ**, **RANGE** and **TIMER START**. These keys offer the following features.

AC Selects **AC** output for selected voltage and/or current generators.

DC Selects **DC** output for selected voltage and/or current generators.

PHASE Denotes the **PHASE** key and sets the phase angle (in degrees) of the selected voltage and/or current generators' AC output. PULSAR unit will display the input real number in the range of 0 to 359.9 degrees only. Any angle greater than 359.9 degrees simply wraps around. For example, entering an angle of 600 degree displays 240.

FREQ Denotes the **FREQUENCY** key and sets the frequency of the selected generator(s) in Hertz. However, when the frequency is changed, it will be out of phase until all the generators are shut off or until the **Restore Phase** procedure is executed (more later on **RST PH**). To indicate this condition the generator whose frequency is changed will show dashes at its phase display.

RANGE Denotes the **RANGE** key and sets the range for the selected voltage and/or current generators. The range option is only allowable when the relevant generator is off; otherwise it is a generator range error.

NOTE: The generator range number, which may be zero (automatic ranging) or the maximum number desired in volts or amps, not to exceed 300 in volts or 30 in amps. The PULSAR unit will choose the lowest range which contains the desired value. For example, if 150 volts is selected for a voltage generator, the 300 volt range will be selected. The following ranges are available:

0 - automatic ranging.

300 - Voltage generator: 300 volts.

30 - Voltage generator: 30 volts.

30 - Current generator: 30 amps.

15 - Current generator: 15 amps.

3 - Current generator: 3 amps.



Application Note: If manually performing dynamic tests (prefault to fault switching) it is recommended that the selected output modules be set to the highest ranges, i.e. 300 volts and 30 amperes.

real - indicates the value of the amplitude, phase, or frequency expressed as a **real** number in decimal form. Allowed values for this variable are:

<u>VARIABLE</u>	<u>RANGE</u>	<u>RESOLUTION</u>
AC Voltage:		
range 300	0 to 300 V _{RMS}	0.02 V _{RMS}
range 30	0 to 30 V _{RMS}	0.002 V _{RMS}
AC Current:		
range 30	0 to 30 A _{RMS}	0.02 A _{RMS}
range 15	0 to 15 A _{RMS}	0.02 A _{RMS}
range 3	0 to 3 A _{RMS}	0.002 A _{RMS}
DC Voltage:		
range 300	-300 to +300 V	0.04 V
range 30	- 30 to + 30 V	0.004 V
DC Current:		
range 30	-30 to +30 A	0.04 A
range 15	-15 to +15 A	0.04 A
range 3	-3 to + 3 A	0.004 A
Phase	0 to 359.9	0.1 Degree
Frequency	0 to 20 000 Hertz	0.00005 Hertz

TIMER START

Denotes the **Timer Start** key; resets the timer monitor and starts timing at the next depression of the **EXECUTE** key. (For complete operational understanding please see **TSOS** key which defines the term "change of state".)

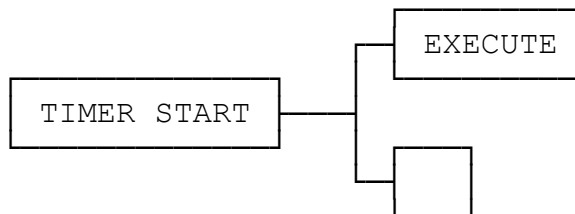

The timer will stop when the timer stop-gate changes state unless the **TSOS** function is active. The timer monitor may also be started with a change of state of the start binding posts.

Example: **TIMER START, EXECUTE**. Starts the timer immediately.

KEYPAD/SYNCHRONIZATION:

Right below the **SETTING/AMPLITUDE** menu is the alpha-numeric keypad which also offers synchronization features (**SYNC**). Most keys on the keypad have two possible functions. They can be used to enter numeric data in normal fashion. The other function is indicated by the letters printed in the shaded blue letters. These keys require prefix - prior to pressing the target key at its lettered description. This is done by pressing the **Shift** key, which is located next to the **OUTPUTS** menu and below the **RAMP** menu.

The **Shift** key is not labeled. It is a vertical rectangular box with a blue inset. This **Shift** key must be released prior to pressing the target key. The **Shift** key's effect only lasts for the next one keystroke.

The following features require the **Shift** key as prefix and the **EXECUTE** key as terminator (executor).

SYNC/PR Denotes master **Phase Reference** key and indicates that subsequent procedures will be executed at the master generator's positive zero-crossing phase reference. The generator located in the bottom right-hand slot of the PULSAR is the master generator.

NOTE: The master generator may be set to any desired angle and will not affect the phase reference to other output modules.

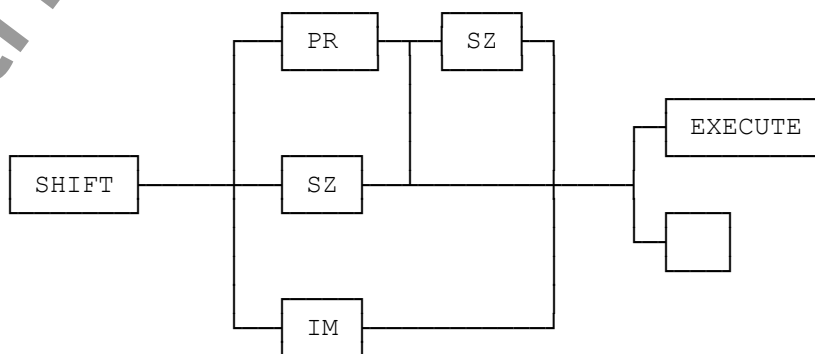

NOTE: The master generator is for reference only. It does not have to be set to zero degree, since all angles are relative.

- SYNC/SZ** Denotes the **SZ (Self Zero)** key and indicates that subsequent procedures will be executed synchronous with each generator's own positive going zero crossing (self zero crossing).
- SYNC/IM** Denotes the **IM (Immediate)** key and indicates that subsequent procedures will be executed **immediately** (point on waveform).
- PRSZ** Denotes the **PRSZ (zero crossing after master phase reference)** keys and indicates that subsequent procedures will be executed at the first zero crossing after the master generator phase reference. **NOTE: PRSZ** is the combination of the keys **PR** and **SZ** which must be pressed sequentially for proper operation.

Example: **Shift, PR, EXECUTE** - execute procedures at the master generator's phase reference.

LINE SYNCHRONIZATION

PULSAR was designed to be completely independent of the line voltage and frequency. However, there may be applications where synchronizing to the line frequency may be desirable. PULSAR units built from 1992 to June, 1996 may not have this feature, unless the Input Power Control Module, PN:12189, has been upgraded. With Line Synchronization activated, the output voltages and currents will be in phase with the input power line (± 2 degrees) if the phase setting on the PULSAR outputs is zero degrees. Output settings other than 0 degrees will **Lag** the input power line by the value displayed on the channel. The outputs will stay synchronized as long as the line frequency does not change more than ± 1 Hertz.

1. To switch from the default **Phase Reference** mode to **Line Synchronous**, press the **Shift** key followed by the **ON** key. The frequency display on each output module will change from 60.000 (or 50.000) Hertz (indicating internal sync mode) to 60 (or 50) Hertz (indicating line sync mode) .

Example: **Shift, ON, EXECUTE**

2. To return the unit to Internal Synchronization mode, press the **Shift** key followed by the **OFF** key. The frequency display on each module will change from 60 (50) Hertz to 60.000 (50.000) Hertz.

Example: **Shift, OFF, EXECUTE**

3. When controlling the PULSAR by a computer, the command **LSI** , will switch the unit to **Line Synchronous Mode**.
4. Sending the command **LSX**, will turn off the Line Synchronous Mode and return the unit to the Internal Synchronous mode.

NOTE: After switching to Line Synchronous Mode, allow a couple of minutes for the PULSAR to synchronize to the line. **Reset** of the PULSAR, either manually or by a computer will cause the PULSAR to **return to the Internal Synchronous Mode**.

SINE Denotes the **SINE** key and indicates that a full wave sinusoidal waveform is to be generated by the selected generator(s).

HWAVE Denotes the **HWAVE** key and indicates that a position **half-wave** sine wave is to be generated by the selected generator(s).

Example: **Shift, HWAVE EXECUTE** - the previously selected generators will generate a half-wave sinusoidal waveform.

NOTE: The selected generator(s) HERTZ display will be a dashed line indicating that the output will be a half-wave, until reset or the SINE function is selected.

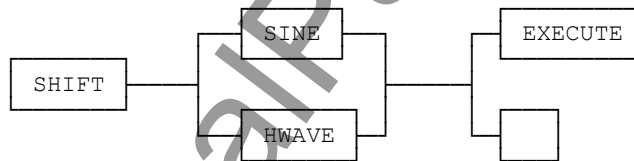

The following three features **HORN**, **CY/SE** and **TSOS** are not functional if the PULSAR unit does not contain a Timer-Monitor module.

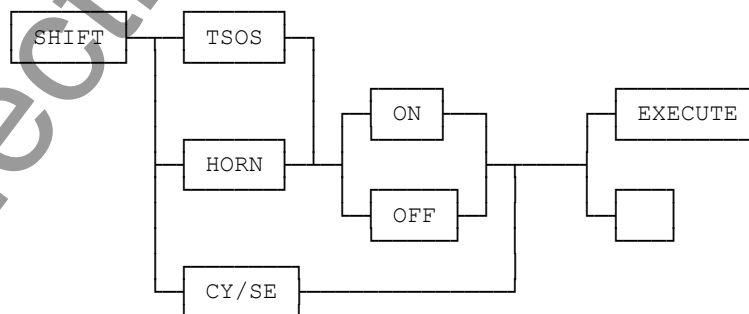

HORN Denotes the **HORN** key and indicates a start timer horn or a stop timer horn function. The **ON** and **OFF** keys from the **OUTPUTS**

menu must follow the **HORN** key in order to activate and deactivate the timer horn.

Example: **Shift, HORN, ON, EXECUTE**. This key sequence will turn the HORN on in association by the MONITOR (continuity).

CY/SE Denotes the **CY/SE** key (**CYcles/SEconds**) and indicates that the display output of the timer is toggled between cycles and seconds. In cycles mode an automatic division of the number of seconds by the period is performed. The period is known from the internal jumper selected frequency (50 or 60 Hz). In seconds mode the display output is in seconds. The default is seconds.

TSOS Denotes the **TSOS** (**T**imer **S**top **O**n **S**ynchronization) key and indicates that if the **ON** (located under **OUTPUTS** menu) key is pressed next:

the timer start gate will be activated when there is a change of state. A change of state occurs when an input binding post changes from:

- (a) continuity to no continuity;
- (b) no continuity to continuity;
- (c) voltage applied to voltage removed;
- (d) no voltage applied to voltage applied.

Example: When testing an auto-synchronizing relay, the Timer will start when the relay closes its contacts at the advanced angle.

the timer stop gate will be activated when the two selected generators are synchronized (for the above example, the time indicated should be the closing time of the breaker).

If the **OFF** (under **OUTPUTS** menu) key is pressed next after the **TSOS** key, this function is canceled.

RST PH Denotes the **RST PH** key; restores the phase relationship of all generators. When the frequency of a generator is changed, its phase relationship to the other generators will be unpredictable. To indicate this condition the generator whose frequency is changed will show dashes at its phase display. The phase will be restored when **RST PH** is executed.

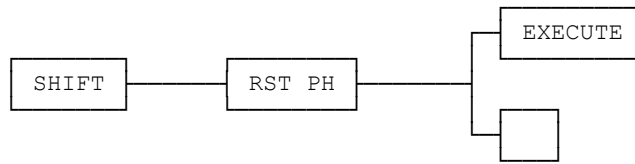

The restoration of phase will occur at the next zero crossing of the master generator. Phase is automatically reset whenever all voltage and current generator outputs are off.

Example: **Shift, RST PH, EXECUTE** - restore the phase relationship of all generators.

A-OFF

Denotes the **A-OFF** (auto off) key and allows the user to have all outputs turned off whenever the stop gate of the timer-monitor changes state.

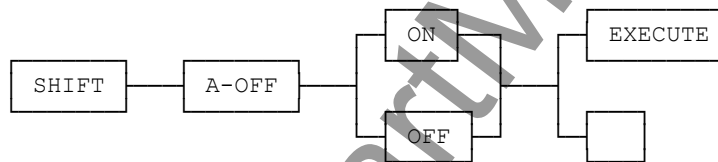

If used with the **ON** key, indicates that the **A-OFF** (AUTO OFF) function is in effect. And, if used with the **OFF** key, indicates that the **A-OFF** function is canceled.

Example: **Shift, A-OFF, ON, EXECUTE** - turn off all outputs whenever the timer changes state.

OUTPUTS MENU:

Directly below the alpha-numeric keypad is the **OUTPUTS** menu which offers the following items:

ON

The primary function of the **ON** key is to control the voltage and/or current outputs. This key, along with the **EXECUTE** key turns selected generators' output (both AC and/or DC parameters) on.

It may also be used after the **TSOS** key or the **HORN** key. Its use for the **TSOS** key has been explained earlier (see **TSOS**). For **HORN** key it indicates a timer horn enable, which applies to both start timer horn and stop timer horn. When enabled, the horn will sound whenever the timer input binding posts have voltage applied and/or continuity.

Can also be used with the **A-OFF** key (see **A-OFF**) to enable the auto off function throughout a certain operation.

OFF The **OFF** key also controls the outputs of different PULSAR modules. Along with the **EXECUTE** key it turns off the outputs of selected generator(s).

It may also be used after the **TSOS** key or the **HORN** key. Its use for the **TSOS** key has been explained earlier (see **TSOS**). For **HORN** key it indicates a timer horn disable which applies to both start timer horn and stop timer horn. When disabled, the horn will be disconnected from the timer input binding posts.

Can also be used with the **A-OFF** key (see **A-OFF**) to disable or cancel the auto off function throughout a certain operation.

EXECUTE This key allows immediate execution of function(s). Any string of allowable and applicable keys that were pressed prior to pressing the **EXECUTE** key is executed immediately.

CANCEL Denotes the "**CANCEL**" key and it allows the cancellation of all entered procedures since the previous **EXECUTE** key was depressed. It works in conjunction with the **Shift** i.e., it requires the **Shift** key as prefix. If no procedures were entered via keys since the last **EXECUTE** key was pressed, this function does nothing. If this function is entered more than once consecutively, it accomplishes no more than if it were entered once.

This procedure is unique in that it is executed immediately, i.e., without waiting for a subsequent execute key or the start of a subsequent procedure.

RAMP MENU:

Located directly above the **Shift** key are the **Ramp** keys which allow the user to ramp up or down any selected output(s) that include AC/DC voltage, current, phase angle and frequency. It incorporates four up-arrow keys and four down-arrow keys that cause the previously selected generators to increment (if up-arrow) or decrement (if down-arrow) at the selected increment or decrement rates.

The increment or decrement values vary depending on what is being ramped and what range the output is set for.

When incrementing the amplitude or the phase angle, the top-most up-arrow key increments the most significant digit and the bottom-most up-arrow increments the least significant one. When incrementing, the bottom-most down-arrow key decrements the most significant digit and the top-most down-arrow key decrements the least significant one. The size of increment or decrement is determined by the **RANGE**. The ramp rate is set to 2 digits per second. For

example, the amplitude of the current channel may be ramped in increments of 2 (top-most up-arrow), .2 (second up-arrow from top), .02 (third up-arrow from top) or .002 (fourth up-arrow from top or the bottom up-arrow) amperes/second in the 3 amp range.

1.3 Timer-Monitor And Battery Simulator Module

The Timer-Monitor and Battery Simulator Module is designed to slide into or out of the PULSAR unit. It contains the programmable trigger inputs for the START, STOP, or CONTINUITY gates, banana plug receptacles, TIMER, an auxiliary programmable dry contact and Battery Simulator option of 48, 125 and 250 volts dc.

The Timer is specifically designed to measure high speed operation of electro-mechanical, solid-state and microprocessor-based protection relays. In addition, it will also perform timing tests on EHV to low voltage breakers, trip circuits and contactors. It incorporates three sets of banana plug receptacles, which can be programmed to be; Start, Stop Gates and Monitor, or all Stop Gates, or all Contact Continuity Monitors.

The programmable auxiliary contact may be programmed for a normally open or normally closed by software command, refer to PULSEMASTER instruction manual.

The Battery Simulator has four terminals providing three voltages 48, 125 and 250 volts dc. The primary application is to provide dc logic voltage to solid-state and microprocessor relays.

The features of the **TIMER-MONITOR AND BATTERY SIMULATOR MODULE** are described in detail:

TIMER Display Indicates elapsed time either in seconds or in cycles. The TIMER is set either by software command, refer to PULSEMASTER manual, or by the keypad with the following commands **Shift, CY/SEC, EXECUTE** and the TIMER display will indicate SECONDS or CYCLES.

START, STOP, MONITOR Gates Three identical, independent, programmable START (top binding posts Terminal 1), STOP (middle binding posts Terminal 2) or MONITOR (bottom binding posts Terminal 3) gate circuits permit simple selection of the desired mode of timing or contact monitoring operation. To monitor operation of the contacts or trip SCR in the device under test, a continuity "ACTIVE" light is provided for each gate. The gate circuit is isolated for voltage-sensing and can monitor solid-state logic signals. Upon sensing continuity or a voltage signal the "ACTIVE" lamp will glow and (if desired) a tone

generator (horn) will sound. The power-up default states for the START/STOP and MONITOR gates are CONTINUITY, Change of State (Normally Open, N.O. closing or Normally Closed, N.C., opening). To change a gate to VOLTAGE, Change of State (Voltage Applied, Voltage Removed) see the following example. Example; change Timer Stop (Terminal 2, second set of terminals) to VOLTAGE, Applied. Use the following key strokes, **Shift, TIMER START, 2, EXECUTE**. The LED indicator should toggle from CONTINUITY to VOLTAGE. NOTE: To toggle back, repeat the above key strokes. The following modes are provided for the Start/Stop/Monitor Gates:

- a) Dry Contacts Open - timer starts, stops or continuity indicator goes out at the opening of normally closed contacts or when conduction through a semiconductor device, such as a triac or a transistor, is interrupted.
- b) Dry Contacts Close - timer starts, stops or continuity indicator glows at the closing of the normally open contacts or upon conduction through a semiconductor device such as a triac or a transistor.
- c) Application or Removal of ac or dc voltage timer starts, stops or continuity indicator glows (application) or darkens (removal) upon the application or removal of either an ac or dc voltage. The voltage threshold is adjustable by turning the small pot located between the Red and Black binding posts from 1 to 4 volts, ac or dc positive going signal. A higher threshold voltage helps to eliminate false triggers due to noisy source. Lower thresholds allow starting and stopping of timer from TTL voltage signals. The maximum allowable voltage applied is 300 volts AC or 300 volts DC, limited by MOV transient protection.
- d) The Timer can be started when turning on any (or all) selected generators. The Timer will stop and selected outputs turn off when using the A-OFF feature.

- e) The Timer can be started simultaneously with a change in Frequency, Phase Angle, Amplitude or a waveform (voltage or current) step.
- f) The Timer can be stopped upon Phase Synchronization between two voltage channels (normally used to time auto synchronization relays, see Operating Procedures, Testing Auto-Synchronizing Relays).

CONTINUITY/VOLTAGE Indicator To manually to toggle between CONTINUITY (N.O./N.C. Dry Contact Change of State) and VOLTAGE (AC/DC Applied/Remove Change of State) for any of the Timer Start/Stop/Monitor gates use the following example.

Example: **Shift, TIMER START, 3, EXECUTE** - Will toggle the Timer Terminal 3, (MONITOR gate is default for Terminal 3) from CONTINUITY to VOLTAGE.

To change from VOLTAGE back CONTINUITY, repeat the commands reverses the condition.

Application: Stop Timer when DC voltage applied. The default setting of the Timer Stop (Terminal 2) is CONTINUITY. Press **Shift, TIMER START, 2, EXECUTE**. Terminal 2 changes to VOLTAGE Applied/Remove.

START LATCH When selected "LATCHED", the Start Latch allows timing to be initiated by a Start Gate and to be stopped only by the selected Stop Gate. When "UNLATCHED", the Start Latch allows timing to be stopped when the Start Gate is reversed (such as when timing the closing and opening of a single contact as in measuring the trip-free operating time of a circuit breaker).

STOP LATCH When "LATCHED", the Stop Latch allows timing to be stopped at the first operation of any Stop Gate (thus ignores contact bounce). When "UNLATCHED", the Stop Latch allows timing to be stopped by any Stop Gate and then restarted if the Stop Gate reverses (provided a Start Gate is still energized), and then stopped again when the gate reverses (total time including contact bounce).

TIMER Reset

The Timer is defaulted to automatically reset when the **TIMER START, EXECUTE** Keys are pressed. Should it be desired to Reset the Timer due to change of the Time Start/Stop terminals (i.e. change from Normally Open, N.O., to Normally Closed, N.C.) condition, then the operator will need to manually reset the Timer using the following key strokes, **Shift, 6, EXECUTE**. NOTE: The number 6 key does not have a Blue Function shown. Think of it as the Timer Reset function key.

START/STOP GATE DE-BOUNCE

The timer can be programmed to ignore temporary state changes that are less than a programmable duration. This is useful for eliminating false triggering and contact bounce errors.

De-bounce Period: 0 to 999 milliseconds.
Resolution: 0.1 ms.

AUXILIARY CONTACT

A pair of banana receptacles provide access to the programmable dry contacts. The contacts may be opened or closed by software command, refer to the PULSEMASTER instruction manual.

Maximum Switching Voltages: 110 volts AC or 30 volts DC.

Maximum Switching Currents: 0.3 amps AC or 1.0 amps DC.

Opening Time: 0.5 ms typical.
Closing Time: 1 ms typical.

BATTERY SIMULATOR

Four banana plug receptacles provide the following voltages 48, 125 and 250 volts dc. Only one output voltage may be used at a time. The maximum output power is 60 watts.



NOTE: dc voltage is ON and available when PULSAR is turned on by the ON/OFF switch. Do not plug or insert any test lead into the BATTERY SIMULATOR binding posts without first connecting the test leads to the load!

1.4 Voltage Generator Module

The Voltage Generator Module is also designed to slide into or out of, a single PULSAR module slot. **One module can provide either ac or dc voltage output** of 0 to 30 Volts_{RMS} or 0 to 300 Volts_{RMS}.

VOLTS Display This four digit LED display indicates the amplitude of the voltage output.

DEGREES Display This four digit LED display indicates the phase angle of the voltage output in positive phase rotation angles. Where V_1 is 0.0° , V_2 is 120.0° , and V_3 is 240.0° (V_2 lags V_1 by 120.0° and V_3 leads V_1 by 120.0°).

FREQUENCY Display This five digit LED display indicates the frequency of the voltage output. For DC voltage the display will show zero.

STATUS Display Located right below the Frequency display is the STATUS display, which displays output status (on or off) and DC offset when applicable.

Red and White Voltage Binding Posts Provides for connection to voltage output. The White binding post is grounded and should be used as the instantaneous non-polarity terminal with the red terminal as polarity. The ground (earth) terminal is connected to the chassis ground.



Error Indication and Alarm Circuitry is incorporated to indicate whenever the amplitude, phase angle, and/or waveform of the voltage source is in error. When an error is detected, the amplitude display will flash and the alarm will sound.

1.5 Current Generator Module

The Current Generator Module is also designed to slide into the PULSAR unit. Each current module takes up two slots of a PULSAR unit. **One module can provide either ac or dc current output**, 0 to 3 amperes, 0 to 15 amperes or 0 to 30 amperes.

AMPERES Display This four digit LED display indicates the amplitude of the current output.

DEGREES Display This four digit LED display indicates the phase angle of the current output.

FREQUENCY Display This five digit LED display indicates the frequency of the current output. For dc current the display will show **dc**.

STATUS Display Located right below the Frequency display is the STATUS display, which displays output status (on or off) and DC offset when applicable.

Black and White Current Binding Posts



Provides for connection to current output. The White binding post is grounded and used as the instantaneous non-polarity terminal with the Black terminal as polarity. The ground (earth) terminal is connected to the chassis ground.

Error Indication and Alarm Circuitry is incorporated to indicate whenever the amplitude, phase angle, and/or waveform of the current source is in error. When the error is detected, the amplitude display will flash and the alarm will sound.

1.6 High Current Interface Module

The High Current Interface Module is designed to slide into the PULSAR unit. Each Module takes up 1 slot of the unit. See installation instructions below. The Module is designed to interface with the AVO Multi-Amp Models EPOCH-20 or EPOCH-II, High-Current Output Units (see EPOCH-20 or EPOCH-II Bulletins for output specifications). This module provides control of the EPOCH-20 or EPOCH-II current amplitude, phase angle and frequency output. Status of the EPOCH-20/II output can be seen on the front panel display.

AMPERES Display This four digit LED display indicates the amplitude of the current output.

DEGREES Display This four digit LED display indicates the phase angle of the current output.

FREQUENCY Display This five digit LED display indicates the frequency of the current output.

NOTE: The EPOCH-20 or EPOCH-II output frequency is limited to 5 Hz. (lowest output frequency). The output compliance voltage and Volt-Ampere output is derated linearly to 50 % of specification from 40 Hz. to 20 Hz.

INSTALLATION

To install the interface module may require the removal of another output module, see Section F, REPAIR DATA, Removal of Current Amplifier Module for instructions to remove the output module from the chassis. Since the current output module takes up two slots and the interface module only uses one, a blank module is required to fill the void slot. If the interface module was ordered separately, then it is provided with a blank module.

WARNING: The blank module must be installed in the empty slot prior to operating the unit, since **dangerous high voltage is present on the inside back plane connector.**



NOTE: Remove Current Output Module #1 for use with PulseMaster software.

To install the interface and blank modules, carefully slide the modules into the chassis. Make sure they are properly seated into the back plane connectors by pressing firmly on the front of the module. Screw back panel knurl knobs onto the interface and blank modules. Reinstall front panel screws.

Hardware interface connections are made on the back of each unit using the interface cable provided in the accessory kit. The cable connectors fit the EPOCH-20 interface connectors. An adapter connector mates with the interface cable to connect to the EPOCH-II signal INPUT connector.

OPERATION

Turn **ON** the PULSAR, all current and voltage modules except for the EPOCH-20/II **HIGH CURRENT INTERFACE MODULE** will display zeroes and system frequency. The high current module will have dashed lines (- - -) in the amperes display. Turn ON the EPOCH-20/II test set then press the **Reset** button on the PULSAR, the dashed lines will be replaced with zeroes. The unit is now ready to use. Refer to the EPOCH-20/II Instruction Manuals for proper operation.

When a relay test is completed and the **HIGH CURRENT INTERFACE MODULE** is no longer required, turn **OFF** the EPOCH-20/II test unit. If a DC target test is required and if you are using PulseMaster, with the EPOCH-20/II off (EPOCH-20/II cannot provide DC current, but PULSAR current modules can) press the **Reset** button on the PULSAR. This will cause PULSAR to default to the second current module. The test can now be conducted.

The **HIGH CURRENT INTERFACE MODULE** can be left in the left most slot until further needed. The second and third current modules can be used to do other relay testing. When using PulseMaster, always remember to press the **Reset** button on the PULSAR before accessing another high current relay test file.

1.7 Back Panel

The input line cord, ground terminal, interconnecting plugs, and RS-232C port are mounted on the back panel of the test set. The following is a description of each item.

Input Line Cord



The test set is equipped with a suitable line cord which is part of the accessory kit, it connects to the male plug on the back panel. Verify input voltage before connecting the line cord to the source of power. **NOTE:** Unit can be powered up from an input source with a rating of 95 Vac to 265 Vac. PULSAR can automatically select (or adjust to) the available power if it is within the specified range mentioned above.

Unit is equipped with an internal fuse.



A chassis ground (earth) point on the back panel is provided as an additional safety ground. A ground is provided at the input power connection.

IEEE-488 GPIB (Optional) Bus Connection

The optional General Purpose Interface Bus (GPIB) enables the PULSAR to function as a talker-listener with any controller or computer which conforms to the IEEE-488 Bus connector.

The significant benefit for having this option will enable the user to download DFR and EMTP files faster than using the RS-232 port.

SERIAL INTERFACE

Provides communication port for control by computer. PULSAR requires a straight 9 pin, female to female communication cable. See Appendix A for PULSAR Remote Operation Command Set and communication protocol.

SYNC IN

Used with the Sync Out from another PULSAR unit or other TTL (+ 5Vdc) signal source (Trigger from a GPS satellite receiver). Primarily used to trigger an operation or programmed event.

SYNC OUT	Used to provide a TTL signal to another PULSAR unit for multiple box operation.
CLOCK IN	Used with the Clock Out from another PULSAR unit or other Clock Source for special testing applications. Normally used for multiple box operation to phase lock.
CLOCK OUT	Used to provide a 214.7 Khz clock signal to another PULSAR unit for phase locking multiple boxes.
EXPANSION INTERFACE	Provided for future expansion and special applications.
Analog Connectors	Each output module has a 3 pin, female, mini-DIN connector. An analog signal of $\pm 5 V_{peak}$ = Full Scale output. CAUTION: Do not exceed $\pm 5 V_{peak}$! Do not apply a square wave with a 5 Vpeak. To do so will cause damage to the amplifier. If square waves are required, it is recommended that 3.5 to 4 Vpeak not be exceeded. Contact factory for details regarding pin connections.

B. INITIAL SET-UP

Unpack the unit and check for any evidence of shipping damage. If visual damage is present, notify freight carrier to make damage claims. Also, notify the factory. The covers are easily removable for access to the front and back panels.



CAUTION

Potentially lethal voltages can be present on the output terminals. It is recommended that the operator thoroughly read the instruction manual and understand the operation of the test set before energizing. An operational check may be performed as follows to verify that the amplitude, phase angle and monitor circuits are functioning properly.

1. Before plugging in the unit, make sure the POWER ON/OFF Switch is OFF.
2. Plug the line cord for the test set into a suitable source of power and switch the POWER ON/OFF Switch ON.
3. It is recommended that all the current and voltage amplitudes and phase angle controls be checked using external instrumentation before placing unit in service.

SELECTION OF MASTER MODULE

When the unit comes from the factory, there will be a generator module (either current or voltage) in the lower right-hand corner of the unit for **phase synchronization**. If you want to change the configuration (i.e., re-arrange the placement of the modules) **you must have a module in the lower right-hand corner slot**, see DESCRIPTION of CONTROLS, SYNC/Phase Reference.

C. OPERATING PROCEDURES

Introduction

After thoroughly reviewing the theory of operation section of this instruction manual, the operator should have a good understanding of the operation of PULSAR.

Use of PULSAR

This section describes basic operating procedures for using the multiple output modules of the PULSAR Test Set for such applications as paralleling current outputs, conducting harmonic restraint tests, series of potential sources to provide higher than rated potential, testing over/under voltage relays and forming three phase voltage outputs.

1.0 Setting Phase Angle Relationships

Think of each PULSAR module as a vector generator. Each module has an internal zero reference to which it references its phase angle settings, as displayed on the LED readouts. This applies to phase angle settings between the voltage and current modules of a PULSAR. When setting a phase angle between two modules of a PULSAR unit, it is recommended that one module be set at zero degree and the other module be referenced to that module at zero degree. This is for operator convenience and reduces confusion. When setting an angle, the operator has a choice of setting the angle either in the

CLOCKWISE or COUNTERCLOCKWISE direction. Pressing the up-arrow keys on the key-pad increases the phase angle in the clockwise direction from 0.0 to 359.9 degrees. For example, setting an angle of 30 degrees between two modules would vectorially look like

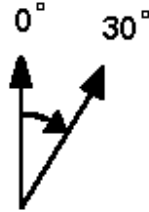

The reference output is 0 degree and the second module is rotated 30 degrees clockwise or **lagging** the referenced source by 30 degrees.

NOTE: All phase angles displayed on PULSAR are lagging phase angles.

Conversely, if the second module were set by pressing the down-arrow keys, the angle decreases in the counterclockwise direction from 359.9 to 0.0 degrees. For example, setting an angle of 300.0 degrees on the second module would vectorially look like . . .

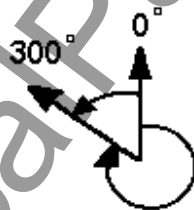

The reference module is 0 degree, and the second module is rotated to 300 degrees in the counterclockwise direction, which is to say that the second module still lags by 300 degrees or leads the reference module by 60 degrees.

1.1 Current Sources-Parallel Operation

When the current source voltage available from a single PULSAR current channel is insufficient to push higher than rated current from any tap, two or three current channels may be connected in parallel to provide the additional current capacity. To parallel the current channels of the PULSAR test set, proceed as follows:

1. Using the current channel test leads, connect each current channel to the relay under test. **The parallel connection must be made at the relay not at the source.** Also, note that all current sources White binding posts are grounded.
2. Switch PULSAR ON.
3. Set the current channels to be used in parallel such that for using two current channels the settings between the two outputs will be one-half and the settings between three current channels will be one-third. Initiate all of the PULSAR current channels together by pressing the following keys **CURRENT, 0, ON, EXECUTE**. All parallel current outputs must be ON to prevent internal shunting of current.

NOTE: All current channels should be set to the same phase angle.

4. All current channels amplitude control now operates simultaneously to provide the desired test current. Total output is the sum of the current displayed on the current channels amplitude display.

1.2 Current Sources-Harmonic Restraint Test

NOTE: To obtain the desired current output necessary to conduct harmonic restraint tests on differential relays, two PULSAR current channels must be used, one current channel will provide the harmonic output and the second current channel will provide the fundamental or "by-pass" current.

There are two methods available in PULSAR to do harmonic restraint tests. One method uses a pure harmonic (2nd, 3rd, 5th, etc) of the fundamental from one current channel, summed with the fundamental current from a second current channel at the relay. The second method uses the PULSAR "HWAVE" feature. The HWAVE simulates the "diode method" recommended in some relay manufacturers instruction literature. When the HWAVE is selected, the selected output module will provide a "half-wave" sinewave (similar to what you would see if using a diode in series with a current source).

NOTE: Most recommended test procedures suggest using 4 amperes DC of half-wave. Since PULSAR displays the full RMS sine-wave quantity, it will be necessary to set 8.89 amperes RMS on the selected HWAVE current channel in order to get the desired equivalent 4 amperes DC half-wave. To calculate other values of DC half-wave use the following formulas,

$$I_{dc} \text{ (half-wave)} = I_{peak} / \pi \text{ and } I_{peak} = I_{rms} * 1.414$$

$$\text{Therefore, } I_{dc} \text{ (half-wave)} = I_{rms} * 1.414 / \pi$$

$$\text{or, } I_{rms} = I_{dc} \text{ (half-wave)} / 0.45$$

$$\text{Solving, } I_{dc} = 4$$

$$I_{rms} = 4 / 0.45$$

$$I_{rms} = 8.89$$

To set up the PULSAR for harmonic restraint testing, use the following procedure:

1. Switch the POWER ON/OFF Switch ON.
2. Select one of the current modules to provide the desired harmonic. Set the current channel to the desired harmonic either second, third, or fifth in conjunction with the FREQ. selector switch. For example, use the following keystrokes to set Current Channel #2 to the second harmonic of 60 Hz; **CURRENT, 2, FREQ, 120, Shift, RST.PH., EXECUTE**. If using the HWAVE feature set; **CURRENT, 2, Shift, HWAVE, EXECUTE**.
3. Connect a pair of current output leads from two of the PULSAR current channels to the relay, so that current from each output will be in parallel with one restraint and the operating coil of the relay. Check to insure both commons (grounds or earths) share the same relay terminal.
4. Initiate the outputs. The output "ON" light should be displayed on the current amplifier front panel.
5. Increase the output to the appropriate harmonic current. It is recommended that one ampere of harmonic current be set (it will make the math easier). If using the HWAVE, set the displayed current to 8.89 amperes RMS (this equals 4 amperes DC half-wave).
6. Increase the fundamental current until the relay operates. To calculate the percent of harmonic restraint use the appropriate equation below (if using pure harmonic current). If using the HWAVE refer to the manufacturers instruction literature for the appropriate % Harmonic Curve.

Type BDD

$$\%_{\text{Harmonic}} = \frac{2_{\text{nd}} \text{ Harmonic Current}}{\sqrt{(\text{Fundamental})^2 + (2_{\text{nd}} \text{ Harmonic})^2}} \times 100$$

Type HU

$$\%_{\text{Harmonic}} = \frac{1.2267 \times 2_{\text{nd}} \text{ Harmonic Current}}{\sqrt{(\text{Fundamental})^2 + (2_{\text{nd}} \text{ Harmonic})^2}} \times 100$$

NOTE: If you used the HWAVE feature, after completion of the test, **restore the HWAVE channel to a sine wave** by pressing **CURRENT, 0, Shift, SINE, EXECUTE**.

1.3 Voltage Sources - Outputs Summed Together

Two PULSAR voltage channels may be used to sum voltage outputs to obtain higher than rated voltage provided the load is not grounded. Simply connect the load between two Red binding posts of the voltage channels, set V_1 Phase to 0 degrees and set V_2 Phase to 180 degrees. The voltage outputs will now add and the voltage amplitude will be the sum of the two voltage amplitudes displayed on V_1 and V_2 amplitude displays. Note that the White common terminals are grounded and are not used.

1.4 Voltage Sources - Dynamic Voltage Relay Test

Over/Under Voltage Relays can be dynamically tested using one voltage channel of the PULSAR test set along with the internal timer. This procedure applies a "normal" voltage to the relay under test and then automatically adjusts the test voltage to a "fault" amplitude either higher for testing over voltage relays or to a lower voltage for testing under voltage relays. Additionally, the timer is automatically started with "fault" voltage applied to the relay under test.

First, set the "normal" voltage on the relay. For example, **VOLTAGE, 1, AC, 120, ON, EXECUTE**. Then, with the relay energized to normal condition, set the desired "fault" voltage and Timer Start (relay trip circuit should be connected to the Timer Stop terminals). If you want to de-energize the voltage to the relay when it trips, use the Auto-Off feature. For example, setting a "fault" voltage of 87 volts with Auto-Off the commands would be: **AC, 87, TIMER START, Shift, A-OFF, ON, EXECUTE**. The 87 volts will be applied, the Timer will Start, the relay trips, stops the Timer and turns the outputs OFF.

1.5 Voltage Sources - 3Ø, 3-Wire, Open-Delta and T-Connection

Open Delta Two methods of obtaining three-phase, three-wire voltage source are available. The Open-Delta configuration (shown in Figure 1) is the easier to use when a balanced three-phase source is required because the amplitude and phase relationship can be set directly. No calculations are necessary.

When using the Open-Delta Configuration to set up a phase-to-phase fault, calculations using the Law of Cosines is required to calculate amplitude and phase relationships. (See discussion

under T-Connection for simulating unbalanced, phase-to-phase faults without need for calculations.)

When using the Open-Delta configuration, it is suggested the voltage channel #1 Red binding post is designated V_1 , voltage channel #2 Red binding post is designated V_3 , while either White COMMON binding post is designated V_2 . With this arrangement, the magnitude and phase angle of the potentials can be easily calculated and set. For the balanced three-phase condition V_{12} and V_{23} are equal in magnitude and separated by an angle of 60° . This is done by setting the V_1 and V_3 potentials equal in magnitude, setting 0 degrees on V_1 and 300° (60 degrees leading) on V_3 , (see Figure 1).

FIGURE 1
BALANCED 3Ø - 3 WIRE FAULT
OPEN DELTA CONNECTION

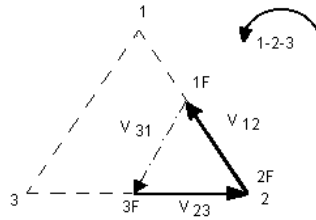

If V_f = Desired Test Potential

Set $V_1 = V_f \angle 0^\circ$

Set $V_3 = V_f \angle 300^\circ$

Voltage Output Connections

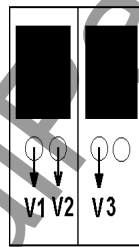

When setting up an unbalanced Open-Delta configuration, the desired phase-to-phase fault voltage, V_{12} is set using voltage channel #1 and its phase angle is set to 0 degrees. Phase-to-phase voltage V_{23} and its phase angle relationship for voltage channel #2, must be calculated using the Law of Cosines; where

$$V_B^2 = (V_A^2 + V_C^2) - 2V_A V_C \cos \beta.$$

Figure 2 shows the phase relationships and an example of the necessary calculation. For user convenience, the amplitude and phase angle settings for typical V_f fault magnitudes are tabulated.

T-Connection

The second method of obtaining three-phase, three-wire 0 voltage source is the T-Connection. This method as shown in Figure 3 is easier to use when obtaining an unbalanced, phase-to-phase fault simulation because it eliminates calculations. To reduce confusion when using the T-

Connection, it is suggested that voltage output #1 be designated V_a and its phase angle set at 0 degrees, voltage output #2 be designated V_b and its phase angle set for 180 degrees and voltage output #3 be designated V_c and its phase angle is set for 270 degrees; any combination of balanced 3θ or unbalanced $\theta - \theta$ fault conditions can be easily simulated. Figure 3 shows the phase relationships.

NOTE: This method is not good for very low fault voltages, i.e., 5 volts or less, or for testing ABB (WESTINGHOUSE) type SKD relays.

1.6 Voltage Source - 3 \emptyset , 4-Wire, Y-Connection

A three-phase, four-wire potential system can be provided using three output modules. The vector relationships are shown in Figure 4. This Y-Connection has the advantage of being able to supply higher line-to-line voltage (1.73 x phase-to-neutral voltage) and is ideally suited for simulating phase to ground faults. Voltage channel #1 is designated as V_a with its phase relationship set for 0 degrees. Voltage channel #2 is then designated as V_b and phase angle set for 120 degrees. Finally, voltage channel #3 is designated V_c and phase angle set for 240 degrees (for a 1-2-3 counter clockwise rotation). V_a , V_b and V_c are then connected to the Red potential binding posts on the respective test sets. If a neutral is required, it is connected to a White potential section binding post on any voltage output module to ground the load.

FIGURE 2
OPEN DELTA CONNECTION
UNBALANCED - θ TO θ FAULT

FROM LAW OF COSINES

$$\theta = \arccos\left(\frac{V_{12}}{2 * V_{23}}\right)$$

$$V_{23}^2 = \left(\frac{V_{12}}{2}\right)^2 + \left(\frac{\sqrt{3}}{2} * 120\right)^2$$

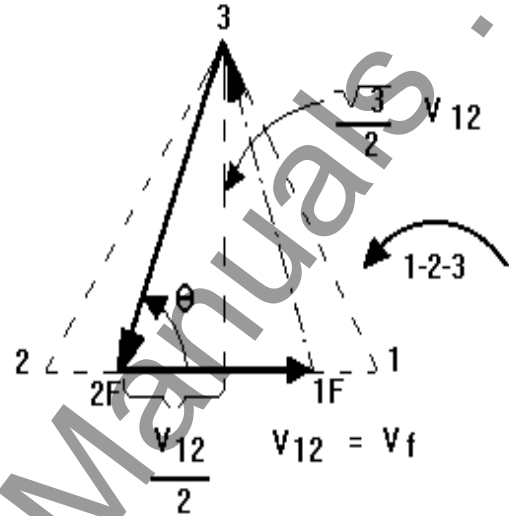

NORMAL BALANCED CONDITION

$$V_{12} = V_{31} = V_{23}$$

Settings For Typical Fault Voltages

	$V_{12} = V_f$															
V_{12}	1	5	10	15	20	25	30	35	40	45	50	55	60	65	70	
V_{23}	104	104	104	104	104	105	105	105	106	106	106	108	108	109	110	
At θ° Lag	270	271	273	274	275	277	278	280	281	282	284	285	286	287	289	

Voltage Output Connections

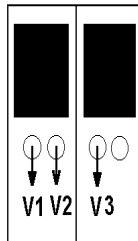
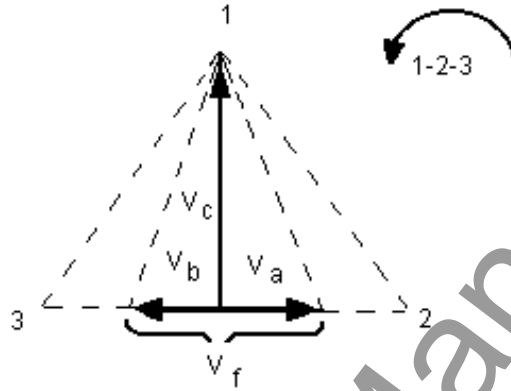

FIGURE 3
BALANCED OR UNBALANCED FAULT
T-CONNECTION



$V_f = \text{Desired Fault Voltage}$

$$V_a = \frac{1}{2}V_f \angle 0^\circ$$

$$V_b = \frac{1}{2}V_f \angle 180^\circ$$

$$V_c = \frac{\sqrt{3}}{2} 120 \text{ or } V_c = 104V \angle 270^\circ$$

Voltage Output Connections

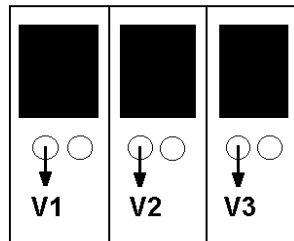
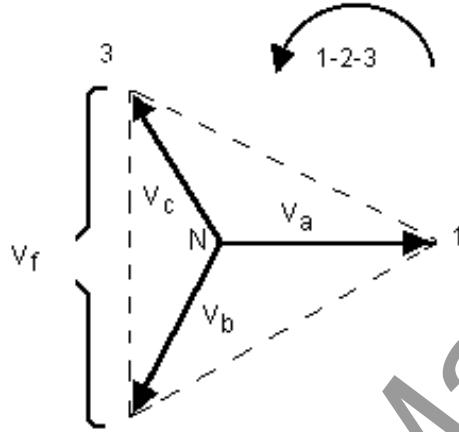

FIGURE 4
BALANCED 3 θ
4 WIRE Y CONNECTION



$V_f = \text{Desired Fault Voltage}$

$$V_a = \frac{\sqrt{3}}{3} V_f \angle 0^\circ$$

$$V_b = \frac{\sqrt{3}}{3} V_f \angle 120^\circ$$

$$V_c = \frac{\sqrt{3}}{3} V_f \angle 240^\circ$$

Voltage Output Connections

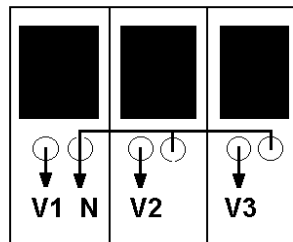

1.7 Manual example for setting up a 3-phase WYE relay test

1.7.1 Connect relay contacts to the monitor gate and energize the audible tone generator by selecting the

SHIFT HORN ON EXECUTE

Assuming all voltage and current tests leads are applied to the relay, to apply a 3-phase voltage of 67 volts 120° separation the following commands are necessary.

VOLTAGE 0 AC 6 7 VOLTAGE 2 PHASE 1 2 0
 VOLTAGE 3 PHASE 2 4 0 VOLTAGE 0 ON EXECUTE

To establish a 3-phase current of 5 amperes with a MTA of 80° and 120° separation, the following commands are necessary

CURRENT 0 AC 5 CURRENT 1 PHASE 8 0
 CURRENT 2 PHASE 2 0 0 CURRENT 3
 PHASE 3 2 0 CURRENT 0 ON EXECUTE

Now to simultaneously ramp the 3-phase current, use the commands;

CURRENT 0 AC ≡ or ∇

And with the appropriate ramp arrow key (up or down), the current amplitude will be ramped simultaneously.

1.7.2 The following is an example of a two stage fault executed manually with a PULSAR. The requirements are as follows:

	Prefault		Fault	
	amplitude	phase	amplitude	phase
V1	67	0	10	0
V2	67	120	10	120
V3	67	240	10	240
I1	1	30	5	50
I2	1	150	5	170
I3	1	270	5	290

The following abbreviations will be used too for the PULSAR keypad.

VOLTAGE GENERATOR = v
CURRENT GENERATOR = c
AC AMPLITUDE = a
PHASE = p
EXECUTE = ;

Example

This series of pushbuttons applies the predefault conditions.

v2,p120,v3,p240,v0,a67,on,c1,p30,c2,p150,c3,p270,c0,a1,on;

This series of pushbuttons loads and executes the fault conditions. Only those parameters to be changed had to be entered.

v0,a10,c0,a5,c1,p50,c2,p170,c3,p290;

1.8 Testing Sync-Check, Synchronizing and Auto-Synchronizing

Relays: To perform tests on synchronizing type relays requires the use of two voltage output modules.

Pick-up or Closing Angle Tests: To perform Pick-up or Closing Angle tests let one voltage channel be the 0° reference, i.e., V1, and let the second voltage channel provide the variable phase angle adjustment, i.e., V2. Remember the phase angle indicated on V2 will be a **lagging angle** (see SETTING PHASE ANGLE RELATIONSHIPS). If the relay's closing characteristic is 20° leading, set an angle of 340° on voltage channel 2.

To set V1 and V2 to 120 volts each and turn on use the following keystrokes,

VOLTAGE, 1,2, AC, 120, ON, EXECUTE

To set V2 to a phase angle of 340° lag (20° lead) use the following keystrokes,

VOLTAGE, 2, PHASE, 340, EXECUTE

To ramp the phase angle of V2 toward 0°, press and hold the appropriate RAMP ▲ arrow until the relay picks up, i.e., 345° (15° leading)

Setting Advance Time: To perform this test let voltage channel 2, V2, provide the slip frequency (generator) and let voltage channel 1, V1, provide the fixed voltage/frequency source (bus). Connect the relay's closing contacts to Timer Start Terminal 1 (top pair of terminals), so that when the relay contacts close (at the advance angle) it will start the timer. Set V1 to the appropriate voltage output and turn on. For example:

VOLTAGE, 1, AC, 120, ON, EXECUTE. Set V2 to an appropriate output voltage and slip frequency, but do not turn on yet. For example:

VOLTAGE, 2, AC, 120, FREQ, 60.100, EXECUTE. V2 DEGREES display

should have dashed lines (the dashes will reset to zero's when the test is executed). Set V1 and V2 to turn on and the Timer to Stop On Synchronization by pressing, **VOLTAGE, 1, 2, Shift, TSOS, ON, EXECUTE**. V2 will turn on in phase with V1, but will slip out of phase at the selected slip frequency. At the advance angle the relay contacts will close, thus starting the timer, when the two voltages slip into phase the Timer will stop. The time indicated will be the advance time setting of the relay. See the following figure for a graphic representation.

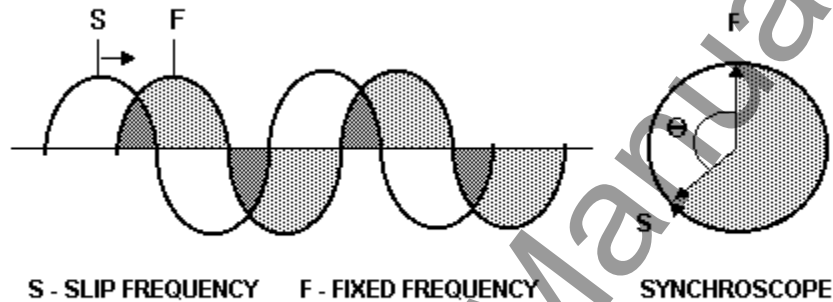

As "S" approaches "F", at some point (the advance angle) the relay will send a close signal, which will start the Timer. When "S" and "F" are in synchronous, the Timer will stop. The time indicated on the timer display is the advance time of the relay based on the preset slip frequency.

1.9 Testing Frequency Relays

The following test guidelines apply generally to all frequency sensitive relays, such as over/under frequency and volts per Hertz.

NOTE: Only one voltage output module is required.

A. Pick-Up Test

To set up the PULSAR for frequency pick-up test, use the following procedure:

1. Switch the POWER ON/OFF Switch ON.
2. Select one of the voltage modules to provide the desired frequency output.
3. Connect a pair of voltage output leads from the selected voltage channel to the relay. Connect a pair of leads from the Timer module, monitor terminals (Terminal 3) to the relay's trip contacts.

4. Set the desired output voltage and initiate the output. For example, use the following keystrokes, **VOLTAGE, 1, AC, 120, Shift, SZ, ON, EXECUTE**. The output "ON" light should be displayed on the voltage amplifier front panel.

NOTE: The SZ (Self Zero) function was selected. This is important. All changes made to the frequency will take place at the positive zero crossing. Most solid-state and microprocessor-based frequency relays determine frequency and timing based on zero crossings.

5. Increase or decrease the output frequency to the appropriate value by selecting FREQ then press the respective Δ or ∇ RAMP buttons until the relay indicates pick-up.

B. Timing Test

Over/Under Frequency Relays can be dynamically tested using one voltage channel of the PULSAR test set along with the timer module. This procedure applies a "normal" voltage and frequency to the relay under test and then automatically adjusts the test voltage to a "fault" frequency, either higher for testing over frequency relays, or to a lower frequency for testing under frequency relays. It should also be noted that the voltage amplitude can be changed with the frequency for more realistic dynamic testing. The timer is automatically started with "fault" frequency applied to the relay under test. To set up the PULSAR for frequency timing test, use the same set-up as for the pick-up test (except move the Monitor leads from Timer Terminal 3 to Timer Stop Terminal 2) and the following procedure:

1. Set the "normal" voltage on the relay. For example, **VOLTAGE, 1, AC, 120, Shift, SZ, ON, EXECUTE** (see NOTE above relative to the SZ mode).
2. With the relay energized to normal condition, set the desired "fault" frequency / voltage and Timer Start (relay trip circuit should be connected to the Timer Stop terminals, Terminal 2). If you want to de-energize the voltage to the relay when it trips, use the Auto-Off feature. For example, setting a "fault" frequency of 58.880 Hz with Auto-Off the commands would be: **FREQ, 58.88, TIMER START, Shift, A-OFF, ON, EXECUTE**. The 58.880 Hz. will be applied, the Timer will Start, the relay trips, stops the Timer and turns the outputs OFF. The Time indicated on the display is the operating time of the relay.
3. ♦ To do a re-test, reset the frequency to the "normal" frequency using the following keystrokes, **FREQ, 60, Shift, RST .PH., ON, EXECUTE**. Repeat step 2.

NOTE: The RST.PH. function was selected to restore phase angle relationship. This is required if conducting a dynamic frequency timing test using three-phase voltage and/or current.

APPLICATION NOTE: To conduct a more dynamic test including a change in voltage amplitude (i.e. change frequency to 50 Hz and amplitude to 100 volts) see the following. In step 2 "setting a fault" use the following keystrokes, **AC, 100, FREQ, 50, TIMER START, Shift, A-OFF, ON, EXECUTE**. The voltage will change to 100 volts at 50 Hz and the Timer will start all at the same time.

4. Once all tests are completed, restore SYNC to Phase Reference using the following key strokes, **Shift, PR, EXECUTE**.

2.0 Testing DC Target And Seal-In

The following test guidelines apply generally to all DC target and seal-in elements. At least one current channel is required to do the target and seal-in test. If two current channels are available, use one current to provide AC current to close the trip contacts and use the other to provide the DC current. The following procedure is based on having two currents available.

NOTE: If two currents are not available, block the trip contacts closed prior to conducting test. Remember to remove the block after the test is completed.

1. Switch the POWER ON/OFF Switch ON.
2. Select one of the current output channels to provide the AC current (for this example current channel 1). Connect a pair of leads to the appropriate relay terminals to energize the relay trip element.
3. Connect current channel 2 to the appropriate relay terminals to energize the DC target and seal-in elements.
4. Set the desired AC test current to approximately 150 % of the relay tap value and turn on. For example, if the relay tap setting is 4 Amperes, use the following keystrokes, **CURRENT, 1, AC, 6, ON, EXECUTE**.
5. When the relay trip element contacts close, energize the relay target coil with DC using the following keystrokes, **CURRENT, 2, DC, ON, EXECUTE**. Ramp up the DC current using the appropriate RAMP Arrow key until the target drops and the seal-in coil picks-up, read and record the DC amperes.

6. Turn off current channel **1** using the following keystrokes, **CURRENT, 1, OFF, EXECUTE**. Note that the seal-in element should still be picked-up. Turn channel 1 back on by pressing **ON, EXECUTE**.
7. Select current channel 2 using the following keystrokes, **CURRENT, 2, DC, EXECUTE**. Slowly reduce the DC current, by pressing the appropriate RAMP arrow key down until the target element drops out, read and record drop out current.
8. Turn current channels 1 and 2 off using the following keystrokes, **CURRENT, 1, 2, OFF, EXECUTE**. Turn test set off.

D. SERVICE DATA

1.1 Servicing

The PULSAR utilizes surface mount technology (SMT) and components which require little or no service except for routine cleaning, tightening of connections, etc. The PULSAR should be serviced in a clean atmosphere away from energized electrical circuits. The following maintenance is recommended:

1. Examine the unit every six months for:
 - a. Dust and other particulate matter collecting on the fins of the heat sinks.
 - b. Moisture condensation inside the lens covers of the display(s).
 - c. Corrosion on the exposed metal surfaces.
2. Remove dust with dry, low pressure, compressed air. Either remove the module from the chassis or simply apply air through the louvers on the front of the module forcing the dust out the rear.
3. Remove moisture as much as possible by putting the test set in a warm, dry environment.
4. As corrosion may take many forms, no specific recommendations can be made for its removal.

1.2 Service and Repair Order Instructions

If factory service is required or desired, contact the factory for return instructions.

A Repair Authorization (RA) number will be assigned for proper handling of the unit when it arrives at the factory.

If desired, a letter with the RA number and instructions can be provided.

Provide the factory with model number, serial number, nature of the problem or service desired, return address, your name, and where you can be reached should the factory need to contact you.

If desired, you may also provide a purchase order number, cost limit, billing, and return shipping instructions.

National Institute of Standards and Technology (NIST) traceable calibration and certification of two types is available, if desired, at additional cost.

Class One: A certificate is provided verifying the traceability and calibration of the equipment.

Class N: That which is required for nuclear power plants. A certificate of traceability and calibration along with "as found" and "as left" data are provided.

If an estimate is requested, provide the name and contact information of the person with approval/disapproval authority.

Pack the equipment appropriately to prevent damage during shipment. If a reusable crate or container is used, the unit will be returned in it if it is in suitable condition.

Put the RA number on the address label of the shipping container for proper identification and faster handling.

NOTE: Ship the equipment **without** instruction manuals or nonessential items such as test leads, etc. These items are not needed to conduct repairs.

1.3 Preparation for Reshipment

Save the shipping container for future use. The shipping container your unit came in is designed to withstand the normal bumps and shocks of shipping via common commercial carrier. For example, you may wish to reship your unit to AVO Multi-Amp for annual calibration certification.

E. WARRANTY STATEMENT

AVO Multi-Amp Corporation warrants to the original purchaser that the product is free of defects in material and workmanship for a period of one (1) year from date of shipment. This warranty is limited and shall not apply to equipment which has damage, or cause of defect, due to accident, negligence, improper operation, faulty installation by the purchaser, or improper service or repair by any person, company or corporation not authorized by AVO Multi-Amp Corporation.

AVO Multi-Amp Corporation will, at its' option, either repair or replace those parts and/or materials that it deems to be defective. Any costs incurred by the purchaser for the repair or replacement of such parts and/or materials shall be the sole responsibility of the original purchaser.

THE ABOVE WARRANTY IS IN LIEU OF ALL OTHER WARRANTIES, EITHER EXPRESSED OR IMPLIED ON THE PART OF THE MULTI-AMP CORPORATION, AND IN NO EVENT SHALL THE AVO MULTI-AMP CORPORATION BE LIABLE FOR THE CONSEQUENTIAL DAMAGES DUE TO THE BREACH THEREOF.

F. REPAIR DATA

It is not always necessary to return the complete PULSAR to the factory for repair. To save turn-around time and reduce costs, PULSAR was designed as a modular unit. In most cases, if any one module should experience a problem it should not cause the test system to be down. Basic troubleshooting information has been provided to guide the technician to the possible source of a problem.

Most of the problems experienced with the PULSAR can be corrected with a replacement module. Since PULSAR uses Surface Mount Technology, most repairs of the individual modules are beyond the scope of the basic troubleshooting guide, and should be referred to the Service Department at AVO Multi-Amp or handled through the AVO Multi-Amp Representative.

If the unit is still within the original warranty period, or limited warranty period following factory servicing, **the factory must be contacted before attempting any repairs or the warranty will be void.**

1.1 Basic Troubleshooting

The troubleshooting information relies on the technician to have a thorough understanding of the operation of the unit. If the technician is unfamiliar with the unit, he or she should not attempt to repair. The technician should contact the factory before attempting repairs. Provide the AVO Multi-Amp part number for the part or assembly in question and the serial number of the PULSAR when making inquiries.

WARNING

It is necessary to energize the PULSAR to properly troubleshoot some of the modules. The technician must take all applicable safety precautions for working on energized circuits.

NOTES

Before suspecting a failure in the PULSAR, review the Description of Controls and Theory of Operation sections to ensure that the problem is not a result of operating error.

Preliminary testing of the PULSAR within its specified limits can help determine if a malfunction actually exists, identify the type of malfunction and define the general area of the failure.

Common causes of malfunctions, other than improper operation, are incorrect power input (voltage above or below specified limits), incorrect test signal voltages applied to the Timer Module Monitor/Start/Stop gates (outside of the specified AC/DC Applied/Removed limits), and contact or circuit resistance too great for the Dry Contact gates to operate properly on the Monitor/Start/Stop gates.

NOTE: Proper ESD procedures should be followed when handling any Pulsar module.

1.2 Power Input

Input voltage affects the whole unit and may or may not cause permanent damage if voltage is incorrect. These problems can often be corrected by simply using a better source of input power. The rated voltage limits is auto-selectable from 95 to 265 volts, 47 to 63 Hz.

Some symptoms are as follows:

1. Low voltage: Erratic operation, no output, fuse operation.
2. High voltage: Fuse operation, power supply failure in Input Power Control Module.

1.3 Input Power and Control Module

Basic troubleshooting of the input power and front panel controls are as follows.

1. No power:
Check power source and line cord.
2. Erratic manual Control
 - A. Individual Output Module or Timer Module is not properly set into the back plane connector, thus cannot receive proper commands.

CAUTION: Turn off main power and unplug line cord before attempting to reseat any module.

Press firmly on front of each suspect module to see if it reseats, check tightness of back panel knurl knobs on each module.

- B. Input Power Control Module is not properly set into the back plane connector. Press firmly on front of the module to see if it reseats, check tightness of back panel knurl knob.
 - C. If only one button appears to be not operating properly, then it is likely that the sealed switch is bad. Contact the Service and Repair Department for return instructions.
3. Removal of Input Power and Control Module:
To remove the module from the chassis,
 - A. Disconnect the power cord from the unit.
 - B. Carefully remove the screws located in the front-bottom of the module.
 - C. Carefully remove the screw, located in the back, which secures the chassis safety ground (earth) wire (green wire) to the chassis. This screw is only accessible through the hole provided, next to chassis ground (earth) point. Use a screw-holding screw driver to remove, else the screw could fall behind the back panel cover.
 - D. Remove the knurl knob retaining screw located on the back panel between the Serial Interface and the Input Power Connector.
 - E. Hold the front of the Module with one hand, and gently, yet firmly, press forward with the other hand on the back fan outlet port. Slide the module forward until you can grasp it with both hands from the front. Carefully remove the module from the chassis.

If all checks good, then power supply failure is probable. Contact factory for return instructions.

1.4 Timer, Monitor and Battery Simulator Module

If all the items external of the Timer assembly are in proper order, then the problem exists within the Timer assembly itself.

It is usually recommended that the complete Timer Module assembly be returned for factory repair if found to be defective. Then any improvements that have been made in the assembly can be incorporated into it during repair and servicing. Some basic troubleshooting can pinpoint problems to the approximate cause.

Basic troubleshooting is as follows:

1. No Timer display when the PULSAR is energized:
Timer Module power supply failure, defective display IC's, defective components on or back panel connections.

CAUTION: Turn off main power and unplug line cord before attempting to reseat any module.

Check Input Power Control and Timer Modules, make sure they are properly seated into the back plane connector. Press firmly on front of the module to see if it reseats, check tightness of back panel knurl knob. If power supply failure is suspect, contact factory or representative for instructions.

2. Weak or defective display:
Poor supply voltage, defective display(s), defective components on display board. See step 1 above for corrective action.
3. Problems with SEC/CYCLES selection:
Defective selector switch(es) on the Input Control Module, defective circuit or defective IC's on timer board. More than likely, problem is selector switch on Control Module (see corrective action under Input Power and Control Module, Erratic Manual Operation). If timer board is suspect, contact factory or representative for instructions.
4. Counting errors:
AC applied or removed Start/Stop signals can create, what appears to be poor repeatability, an inaccuracy or a malfunction in the Timer. The lower the voltage level, the more serious the "error" will be. What appears to be an error, however, is actually a variation in the point on the sine wave at which the voltage is great enough to cause the gate circuit to operate. If the circuit used for the timing test has a low AC voltage and the point at which the contact in the test circuit opens or closes, is at or close to zero on the sine wave, the period of time before the voltage level will be high enough to trigger the gate circuit can be as much as 4 milliseconds. The

total timing variation can be as much as 8 milliseconds. The shorter the duration of the timing test, the more significant the variation becomes. Therefore, if small timing variations would present a problem, it is recommended that an AC voltage of 115 volts or above or a DC voltage be used for voltage applied/removed test selections.

When the PULSAR Timer calibration is being tested, the AC voltage variable is often overlooked. This is particularly true when the Timer is compared to a counter and the two are triggered simultaneously with an electronic switch. For best results, a DC voltage should be used to eliminate the variable. If testing the AC voltage Start/Stop characteristics is desired, then the Start/Stop signal must be triggered at the same point on the sine wave to assure that the gate signal will be repeatable. Ideally, the signal should be at a point near peak in the positive direction. In addition, the specified rms AC voltage values for the various Start/Stop control selections must be adhered to.

Another source of apparent "error" can be the programmable de-bounce feature. If using electro-mechanical contacts for starting and stopping the Timer, and if those contacts have a tendency to bounce, there could be a difference between an external standard timer and the PULSAR Timer, depending on the programmed de-bounce period. To determine the programmed value, use a computer to perform a Timer Query (see Command Set for instructions).

If a timing error or variation persists after all the suspected causes of error have been eliminated, then it is fairly certain the Timer is malfunctioning. Contact factory for return instructions.

5. Removal of Timer Module

To remove the module from the chassis,

- A. Disconnect the power cord from the unit.
- B. Carefully remove the screws located in the front-bottom of the module.
- C. Remove the knurl knob retaining screw located on the back panel.
- D. Hold the front the Module with one hand and gently, yet firmly, press forward with the other hand on the back fan outlet port. Slide the module forward until you can grasp it with both hands from the front. Carefully remove the module from the chassis.

1.5 Voltage Amplifier Module

It is usually recommended that the complete Voltage Amplifier Module assembly be returned for factory repair if found to be defective. Then any improvements that have been made in the assembly can be incorporated into it during repair and servicing. Due to the extensive use of Surface Mount Technology in the amplifier module, there is very little that can be repaired without special tools and training. Some basic troubleshooting can pinpoint problems to the approximate cause.

Basic troubleshooting is as follows:

1. No Voltage Module display when the PULSAR is energized:
Voltage Amplifier Module power supply failure, defective display IC's, defective components on or back panel connections.
CAUTION: Turn off main power and unplug line cord before attempting to reseat any module.
Check Input Power Control and Voltage Amplifier Modules, make sure they are properly seated into the back plane connector. Press firmly on front of the module to see if it reseats, check tightness of back panel knurl knob. If power supply failure is suspect, contact factory or representative for instructions.
2. Weak or defective display:
Poor supply voltage, defective display(s), defective components on display board. See step 1 above for corrective action.
3. DC voltage output with amplifier turned off:
It is normal to have a few millivolts of dc voltage with the output switched off, since the amplifier is dc coupled. However, if the power supply starts to fail, the operator may measure 10's of volts dc across the output binding post. This is an indication that the power supply has a problem and needs to be replaced. Contact factory for return instructions.
4. Removal of Voltage Amplifier Module
To remove the module from the chassis,
 - A. Disconnect the power cord from the unit.
 - B. Carefully remove the screws located in the front-bottom of the module.
 - C. Remove the knurl knob retaining screw located on the back panel.
 - D. Hold the front the Module with one hand and gently, yet firmly, press forward with the other hand on the back fan outlet port. Slide the module forward until you can grasp it with both hands from the front. Carefully remove the module from the chassis.

1.6 Current Amplifier Module

It is usually recommended that the complete Current Amplifier Module assembly be returned for factory repair if found to be defective. Then any improvements that have been made in the assembly can be incorporated into it during repair and servicing. Due to the extensive use of Surface Mount Technology in the amplifier module, there is very little that can be repaired without special tools and training. Some basic troubleshooting can pinpoint problems to the approximate cause.

Basic troubleshooting is as follows:

NOTE:

1. No Current Module display when the PULSAR is energized:
Current Amplifier Module power supply failure, defective display IC's, defective components on or back panel connections.
CAUTION: Turn off main power and unplug line cord before attempting to reseat any module. Check Input Power Control and Current Amplifier Modules, make sure they are properly seated into the back plane connector. Press firmly on front of the module to see if it reseats, check tightness of back panel knurl knob. If power supply failure is suspect, contact factory or representative for instructions.
2. Weak or defective display:
Poor supply voltage, defective display(s), defective components on display board. See step 1 above for corrective action.
3. Removal of Current Amplifier Module
To remove the module from the chassis,
 - A. Disconnect the power cord from the unit.
 - B. Carefully remove the screws located in the front-bottom of the module.
 - C. Remove the knurl knob retaining screw located on the back panel.
 - D. Hold the front the Module with one hand and gently, yet firmly, press forward with the other hand on the back fan outlet port. Slide the module forward until you can grasp it with both hands from the front. Carefully remove the module from the chassis.

II. Testing Procedures

Testing of Westinghouse Type AR Relay

AVO
Multi-Amp

PULSAR

Date: September 30, 1993 Rev: B
IEEE Device Number: 94
Function: Auxiliary

This relay test sheet describes the use of the AVO Multi-Amp PULSAR test instrument to perform the AR's protective relay acceptance tests. Test connections to the AVO Multi-Amp PULSAR relay test set and manufacturer recommended relay settings are included.

References:

Manufacturer's Reference
Literature

I.L. 41-759

Test Equipment
Instructional Material

PULSAR Operating Manual

Description of Relay

The AR relay is a high-speed auxiliary relay used in breaker-failure protection schemes to initiate a breaker-lockout device to restrict energizing of a circuit breaker once a fault has occurred.

PRECAUTIONS

*******WARNING*******

Dangerous and potentially fatal voltage can be developed across the output terminals of the PULSAR relay test set, refer to the PULSAR operation manual for further instructions.

Always turn the outputs **OFF** before connecting, removing or touching any output terminal or test lead, use extreme caution when turning on or using the PULSAR relay test set.

ALWAYS TEST THIS RELAY IN ITS CASE.

SETUP AND PROCEDURE

For each test:

Assign current and voltage sources as indicated in the preset conditions table.

PULSAR TEST CONDITIONS					
ASSIGN	±	N	TEST	∠	Hz
V _A	8	9	120	0°	60.0
MON	10	1			

MINIMUM PICKUP

1. Relay connections are applicable to test either ac or dc voltage relays.
2. Apply rated voltage to relay; **VOLTAGE, 1, AC, 120, ON, EXECUTE.**
3. Using the Ramp Arrow keys, ramp voltage up or down to find minimum pickup value.
4. To turn VOLTAGE 1 Off; **OFF, EXECUTE.**
5. Voltage pickup should be ±10% of tap or relay voltage rating.

TIMING

1. Move monitor leads to timer stop gate on PULSAR.
2. Apply multiples of fault level voltages to AR relay; **VOLTAGE, 1, AC, 80, ON, Shift, A-OFF, ON, TIMER START, EXECUTE.**
3. Subsequent sequences are;
AC, 90, ON, TIMER START, EXECUTE;
AC, 100, ON, TIMER START, EXECUTE;
AC, 110, ON, TIMER START, EXECUTE;
AC, 120, ON, TIMER START, EXECUTE;
Record each individual value.
4. De-initiate auto off function; **Shift, A-OFF, OFF, EXECUTE.**

Testing of General Electric Type BDD 15 & 16 Relays

AVO
Multi-Amp

PULSAR

Date: September 30, 1993 Rev: B
IEEE Device Number: 87
Function: Transformer Differential

This relay test sheet describes the use of the AVO Multi-Amp PULSAR test instrument to perform the BDD15B protective relay acceptance tests. Test connections to the AVO Multi-Amp PULSAR relay test set and manufacturer recommended relay settings are included.

References:

Manufacturer's Reference Literature

GEH-2057F

Test Equipment
Instructional Material

PULSAR Operating Manual

Description of Relay

BDD relays are differential relays designed specifically for transformer protection. The BDD relays are provided with the features of percentage and harmonic restraint and use a sensitive polarized unit as the operation element. Percentage restraint permits accurate discrimination between internal and external faults at high fault current, while harmonic restraint enables the BDD to distinguish, by the difference in waveform between the differential current caused by an internal fault and that of transformer magnetizing inrush.

The BDD relay is a single-phase unit and the BDD15B relay is designed to be used for the protection of a two winding transformer and has two through current restraint circuits and one differential current circuit.

PRECAUTIONS

*******WARNING*******

Dangerous and potentially fatal voltage can be developed across the output terminals of the PULSAR relay test set, refer to the PULSAR operation manual for further instructions.

Always turn the outputs **OFF** before connecting, removing or touching any output terminal or test lead, use extreme caution when turning on or using the PULSAR relay test set.

ALWAYS TEST THIS RELAY IN ITS CASE.

SETUP AND PROCEDURE

For each test:

Assign current and voltage sources as indicated in the preset conditions table. The test values are based upon a 5A tap and 25% slope relay setting.

The dc auxiliary is supplied either using the station dc battery supply or the PULSAR Battery Simulator. The dc terminals to connect are 1 (+) and 7 (-). These settings assume usage of the 125 V version.

PULSAR TEST CONDITIONS						
ASSIGN	CONNECT		TEST	VALUES		HZ
	±	N			∠	
I _A	6	5	I _A	1.2	0°	60.0
I _B	4	5	I _B	1.2	0°	60.0
MON	1	2				

MINIMUM PICKUP

1. Set PULSAR current channels equal to (tap * 0.3) value; **CURRENT, 1, 2, AC, 1.2, EXECUTE.**
2. Turn current (I_A) ON; **CURRENT, 1, AC, ON, EXECUTE.** Using RAMP Arrow keys, ramp current channel up or down to find minimum pickup. Turn I_A off; **CURRENT, 1, OFF, EXECUTE.** Repeat test for current (I_B), all commands for I_B are CURRENT 2.
3. Minimum pickup should be within ±10% of (tap * 0.3) value. Refer to relay instruction manual for adjustment to minimum pickup resistor.

PULSAR TEST CONDITIONS						
ASSIGN	CONNECT		TEST	VALUES		HZ
	±	N			∠	
I _A	6	4	I _A	25	0°	60.0
MON	1	2				

THROUGH CURRENT RESTRAINT

1. Set PULSAR current channel (I_A) equal to 25 amperes; **CURRENT, 1, AC, 25, EXECUTE.**
2. Turn current (I_A) ON; **CURRENT, 1, ON, EXECUTE;** BDD15B relay should be in restraint, (relay's main trip contacts remain open rather than close).
3. Turn current OFF; **OFF, EXECUTE.** Disconnect relay and set up for Harmonic restraint test.

PULSAR TEST CONDITIONS						
ASSIGN	CONNECT		TEST	VALUES		HZ
	±	N			∠	
I _A	6	5	I _A	4	0°	60.0
I _B	6	5	I _B	1	0°	120.0
MON	1	2				

HARMONIC RESTRAINT using pure 2nd Harmonic Current

1. Set I_A and I_B on PULSAR to above parameters; **CURRENT, 2, AC, 1, FREQ, 120, Shift, RST.PH, CURRENT 1, AC, 4, EXECUTE.**
2. Initiate PULSAR; **CURRENT, 2, ON, CURRENT 1, AC, ON, EXECUTE.** Using the RAMP Arrow keys ramp I_A up to find pickup of harmonic restraint trip contact. Record value.
3. De-initiate PULSAR; **CURRENT, 1, 2, OFF, EXECUTE.**
5. Calculate percent harmonic with the formula as referred to under Current Sources-Harmonic Restraint Test.

PULSAR TEST CONDITIONS						
ASSIGN	CONNECT		TEST	VALUES		HZ
	±	N			∠	
I _A	6	5	I _A	4	0°	60.0
I _B	6	5	I _B	8.89	0°	60.0
MON	1	2				

HARMONIC RESTRAINT using H_WAVE (Diode Test Method)

1. Set I_A to above parameters; **CURRENT, 1, AC, 4, EXECUTE.**
2. Set I_B to 8.89A, H_WAVE, to establish 4A I_{dc} (as required for diode test method), refer to section Current Sources-Harmonic Restraint Test; **CURRENT, 2, AC, 8.89, Shift, H_WAVE, EXECUTE.**
3. Initiate I_A and I_B; **CURRENT, 2, ON, CURRENT, 1, AC, ON, EXECUTE.**
4. Using the RAMP Arrow keys, ramp I_A up to find pickup of harmonic restraint trip contact. Record value.
5. De-initiate PULSAR; **CURRENT, 1, 2, OFF, EXECUTE.**
6. Restore to sine wave output; **CURRENT, 0, Shift, SINE, EXECUTE.**
7. Refer to the manufacturers instruction literature for the appropriate % Harmonic Curve.

PULSAR TEST CONDITIONS						
ASSIGN	CONNECT		TEST	VALUES		HZ
	±	N			∠	
I _A	6	5	I _A	4	0°	60.0
I _B	6	4	I _B	20	0°	60.0
MON	1	2				

SLOPE TEST

1. Set I_A equal to 4 amperes and I_B equal to 20 amperes; **CURRENT, 1, AC 4, CURRENT, 2, AC, 20, EXECUTE.**
2. Turn both I_A and I_B ON; **CURRENT, 2, ON, CURRENT, 1, AC, ON, EXECUTE.** Using the RAMP Arrow keys ramp I_A up until main trip

- contacts pickup. Record pickup value, turn I_A and I_B OFF; **CURRENT, 1, 2, OFF, EXECUTE**.
3. Using the formula; %Slope = (I_A/I_B)*100 , calculate the actual BDD15B slope characteristics. Refer to GEH-2057F for tolerances.

PULSAR TEST CONDITIONS						
ASSIGN	CONNECT		TEST	VALUES		HZ
	±	N			∠	
I _A	6	5	I _A	20	0°	60.0
I _B	6	5	I _B	20	0°	60.0
MON	1	2				

INSTANTANEOUS TEST

1. Set I_A and I_B equal to (8 * 5A tap); **CURRENT, 1, 2, AC, 20, EXECUTE**.
2. Turn both I_A and I_B ON; **CURRENT, 1, 2, ON, EXECUTE**. Pulse current to instantaneous unit by turning the current on and off to the BDD relay using the following commands. **ON, EXECUTE; OFF, EXECUTE**.
3. If contacts pickup, reduce current values by 1.0 amp; **CURRENT, 1, 2, AC, 19.5, ON, EXECUTE, OFF EXECUTE**; until main trip contacts pickup. Record pickup value
4. Turn I_A and I_B OFF; **CURRENT, 1, 2, OFF, EXECUTE**.

AVO
Multi-Amp

PULSAR

Date: September 30, 1993 Rev: B
IEEE Device Number: 87
Function: Transformer Differential

This relay test sheet describes the use of the AVO Multi-Amp PULSAR test instrument to perform the BDD16B protective relay acceptance tests. Test connections to the AVO Multi-Amp PULSAR relay test set and manufacturer recommended relay settings are included.

References:

Manufacturer's Reference
Literature

GEH-2057F

Test Equipment
Instructional Material

PULSAR Operating Manual

Description of Relay

BDD relays are differential relays designed specifically for transformer protection. The BDD relays are provided with the features of percentage and harmonic restraint and use a sensitive polarized unit as the operation element. Percentage restraint permits accurate discrimination between internal and external faults at high fault current, while harmonic restraint enables the BDD to distinguish, by the difference in waveform between the differential current caused by an internal fault and that of transformer magnetizing inrush.

The BDD relay is a single-phase unit and the BDD16B relay is designed to be used for the protection of a three winding transformer and has three through current restraint circuits and one differential current circuit.

PRECAUTIONS

*******WARNING*******

Dangerous and potentially fatal voltage can be developed across the output terminals of the PULSAR relay test set, refer to the PULSAR operation manual for further instructions.

Always turn the outputs **OFF** before connecting, removing or touching any output terminal or test lead, use extreme caution when turning on or using the PULSAR relay test set.

ALWAYS TEST THIS RELAY IN ITS CASE.

SETUP AND PROCEDURE

For each test:

Assign current and voltage sources as indicated in the preset conditions table. The test values are based upon a 5A tap and 25% slope relay setting.

The dc auxiliary is supplied either using the station dc battery supply or the PULSAR Battery Simulator. The dc terminals to connect are 1 (+) and 10 (-). These settings assume usage of the 125 V version.

PULSAR TEST CONDITIONS						
ASSIGN	CONNECT		TEST	VALUES		HZ
	±	N			∠	
I _A	6	5	I _A	1.2	0°	60.0
I _B	4	5	I _B	1.2	0°	60.0
I _C	3	5	I _C	1.2	0°	60.0
MON	1	2				

MINIMUM PICKUP

1. Set PULSAR current channels equal to (tap * 0.3) value; **CURRENT, 0, AC, 1.2, EXECUTE.**
2. Turn current (I_A) ON; **CURRENT, 1, AC, ON, EXECUTE.** Using RAMP Arrow keys, ramp current channel up or down to find minimum pickup. Turn I_A OFF; **CURRENT, 1, OFF, EXECUTE.** Repeat test for current (I_B and I_C), all commands for I_B are CURRENT, 2 and I_C are CURRENT, 3.
3. Minimum pickup should be within ±10% of (tap * 0.3) value. Refer to relay instruction manual for adjustment to minimum pickup resistor.

PULSAR TEST CONDITIONS						
ASSIGN	CONNECT		TEST	VALUES		HZ
	±	N			∠	
I _A	6	3	I _A	25	0°	60.0
I _B	6	4	I _B	25	0°	60.0
MON	1	2				

THROUGH CURRENT RESTRAINT

1. Set PULSAR current channel (I_A) equal to 25 amperes; **CURRENT, 1, AC, 25, EXECUTE.**
2. Turn current (I_A) ON; **CURRENT, 1, ON, EXECUTE.** BDD16B relay should be in restraint, (relay's main trip contacts remain open rather than close).
3. Turn current OFF; **OFF, EXECUTE.**
4. Repeat the test for I_B; **CURRENT, 2, AC, 25, ON, EXECUTE.** Turn current OFF; **OFF, EXECUTE.** Disconnect relay and set up for Harmonic Restraint test.

PULSAR TEST CONDITIONS						
ASSIGN	CONNECT		TEST	VALUES		HZ
	±	N			∠	
I _A	6	5	I _A	4	0°	60.0
I _B	6	5	I _B	1	0°	120.0
MON	1	2				

HARMONIC RESTRAINT using pure 2nd Harmonic Current

1. Set I_A and I_B on PULSAR to above parameters; **CURRENT, 2, AC, 1, FREQ, 120, Shift, RST.PH, CURRENT, 1, AC, 4, EXECUTE.**
2. Initiate PULSAR; **CURRENT, 2, ON, CURRENT, 1, AC, ON, EXECUTE.** Using the RAMP Arrow keys ramp I_A up to find pickup of harmonic restraint trip contact. Record value.
3. De-initiate PULSAR; **CURRENT, 1, 2, OFF, EXECUTE.**

4. Calculate percent harmonic with the formula as referred to under Current Sources-Harmonic Restraint Test.

PULSAR TEST CONDITIONS						
ASSIGN	CONNECT		TEST	VALUES		HZ
	±	N			∠	
I _A	6	5	I _A	4	0°	60.0
I _B	6	5	I _B	8.89	0°	60.0
MON	1	2				

HARMONIC RESTRAINT using H_WAVE (Diode Test Method)

1. Set I_A to above parameters; **CURRENT, 1, AC, 4, EXECUTE.**
2. Set I_B to 8.89A, H_WAVE, to establish 4A I_{dc} (as required for diode test method), refer to section Current Sources-Harmonic Restraint Test; **CURRENT, 2, AC, 8.89, Shift, H_WAVE, EXECUTE.**
3. Initiate I_A and I_B; **CURRENT, 2, ON, CURRENT, 1, AC, ON, EXECUTE.**
4. Using the RAMP Arrow keys, ramp I_A up to find pickup of harmonic restraint trip contact. Record value.
5. De-initiate PULSAR; **CURRENT, 1, 2, OFF, EXECUTE.**
6. Restore sine wave output; **CURRENT, 0, Shift, SINE, EXECUTE.**
7. Refer to the manufacturers instruction literature for the appropriate % Harmonic Curve.5

PULSAR TEST CONDITIONS						
ASSIGN	CONNECT		TEST	VALUES		HZ
	±	N			∠	
I _A	6	5	I _A	4	0°	60.0
I _B	6	4	I _B	20	0°	60.0
I _C	4	3	I _C	20	0°	60.0
MON	1	2				

SLOPE TEST

1. Set I_A equal to 4 amperes and I_B equal to 20 amperes; **CURRENT, 1, AC 4, CURRENT, 2, AC, 20, EXECUTE.**
2. Turn both I_A and I_B ON; **CURRENT, 2, ON, CURRENT, 1, AC, ON, EXECUTE.** Using the RAMP Arrow keys ramp I_A up until main trip contacts pickup. Record pickup value, turn I_A and I_B OFF; **CURRENT, 1, 2, OFF, EXECUTE.**
3. Using the formula; % Slope = $(I_A/I_B)*100$, calculate the actual BDD16B slope characteristics. Refer to GEH-2057F for tolerances.
4. Repeat the test for I_A and I_C .

PULSAR TEST CONDITIONS						
ASSIGN	CONNECT		TEST	VALUES		HZ
	±	N			△	
I_A	6	5	I_A	20.0	0°	60.0
I_B	6	5	I_B	20.0	0°	60.0
MON	1	2				

INSTANTANEOUS TEST

1. Set I_A and I_B equal to (8 * 5A tap); **CURRENT, 1, 2, AC, 20, EXECUTE.**
2. Turn both I_A and I_B ON; **CURRENT, 1, 2, ON, EXECUTE.** Pulse current to instantaneous unit by turning the current on and off to the BDD relay using the following commands. **ON, EXECUTE; OFF, EXECUTE.**
3. If contacts pickup, reduce current values by 1.0 amp; **CURRENT, 1, 2, AC, 19.5, ON, EXECUTE, OFF EXECUTE;** until main trip contacts pickup. Record pickup value
4. Turn I_A and I_B OFF; **CURRENT, 1, 2, OFF, EXECUTE.**

Testing of Basler Type BE1-81 O/U Relay

AVO
Multi-Amp

PULSAR

Date: September 30, 1993 Rev: B
IEEE Device Number: 81
Function: Frequency Relay

This relay test sheet describes the use of the AVO Multi-Amp PULSAR test instrument to perform the BE1-81 O/U protective relay acceptance tests. Test connections to the AVO Multi-Amp PULSAR relay test set and manufacturer recommended relay settings are included.

References:

Manufacturer's Reference
Literature

I.L. 41-501.2F

Test Equipment
Instructional Material

PULSAR Operating Manual

Description of Relay

The BE1-81 O/U is a single phase solid-state relay used in protection schemes against the effects of overfrequency or underfrequency.

PRECAUTIONS

*******WARNING*******

Dangerous and potentially fatal voltage can be developed across the output terminals of the PULSAR relay test set, refer to the PULSAR operation manual for further instructions.

Always turn the outputs **OFF** before connecting, removing or touching any output terminal or test lead, use extreme caution when turning on or using the PULSAR relay test set.

ALWAYS TEST THIS RELAY IN ITS CASE.

The BE1-81 0/U Digital Frequency Relay is a solid-state, digital electronic protective device that monitors the frequency of a single-phase of ac voltage to provide accurate frequency protection for 50 Hz or 60 Hz distribution systems and generators.

Test Connections:

125 UDC: 3 AND 4

Frequency sensing: 6 and 7

Contacts: Set point 1, 1 and 10
Set point 2, 8 and 9

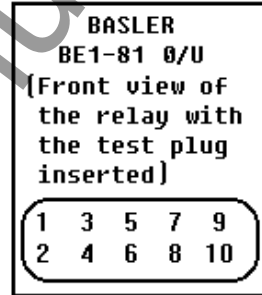

PULSAR

CONTROL MODULE	TIMER	VOLTS	VOLTS	VOLTS
		0 0↗	0 0↗	0 0↗
AMPS		AMPS		AMPS
0 0↗		0 0↗		0 0↗

ALWAYS REFER TO THE MANUFACTURERS' LITERATURE BEFORE TESTING!

Relay Notes:

SETUP AND PROCEDURE

For each test:

The BE1-81 O//U relay is used as an overfrequency and underfrequency characteristics.

Refer to BE1-81 O/U instruction manual for relay settings for OPERATIONAL TEST.

Use Battery Simulator for dc power supply 4(+) and 3(-).

Assign voltage sources as indicated in the preset conditions table.

PULSAR TEST CONDITIONS						
ASSIGN	CONNECT		TEST	VALUES		HZ
	±	N			Z	
V _A	7	6	V _A	80	0°	60.0
MON	10	1				

OVERFREQUENCY TEST

1. Set V_A equal to test parameters and initiate; **VOLTAGE, 1, AC, 80, ON, Shift, SZ, FREQ, EXECUTE**. NOTE: The 80 Volts applied should just exceed the UNDERVOLTAGE INHIBIT sensing circuit, unless it is set higher.
2. Using Ramp Arrow keys ramp V_A frequency up until main trip contacts pickup, 70.01 Hz ±0.005 Hz.
3. Record the minimum pickup value.
4. De-initiate V_A; **VOLTAGE, 1, OFF, EXECUTE**.

UNDERFREQUENCY TEST

1. Set V_A equal to test parameters and initiate; **VOLTAGE, 1, AC, 80, ON, Shift, SZ, FREQ, 50, EXECUTE**. NOTE: The 80 Volts applied should just exceed the UNDERVOLTAGE INHIBIT sensing circuit, unless it is set higher.
2. Using Ramp Arrow keys ramp V_A frequency down until main trip contacts pickup, 40.00 Hz ±0.005 Hz.
3. Record the minimum pickup value.

4. De-initiate V_A ; **VOLTAGE, 1, OFF, EXECUTE.**

FREQUENCY SELECTOR TEST

1. Set V_A equal to frequency test parameters and initiate; **VOLTAGE, 1, AC, 80, ON, Shift, SZ, FREQ, 50, EXECUTE.** NOTE: The 80 Volts applied should just exceed the UNDERVOLTAGE INHIBIT sensing circuit, unless it is set higher.
2. Using Ramp Arrow keys ramp V_A frequency up until main trip contacts pickup, 51.11 Hz \pm 0.005 Hz.
3. Record the minimum pickup value.
4. Repeat steps 1 and 2 for BE1-81 settings of 52.22 Hz, 54.44 Hz, and 58.88 Hz.
5. De-initiate V_A ; **VOLTAGE, 1, OFF, EXECUTE.**

TIMING TEST

1. Set V_A to normal voltage and frequency; **VOLTAGE, 1, AC, 115, FREQ, 60, ON, Shift, RST. PH, SZ, EXECUTE.**
2. Move monitor circuit to timer stop gate. (Terminal 2).
3. Set V_A equal to fault voltage and fault frequency 53 Hz; **VOLTAGE, 1, AC, 80, FREQ, 53, Shift, A-OFF, ON, TIMER START, EXECUTE.**
4. When the relay trips, it will turn off the output and stop the Timer. Record the pickup value. Repeat testing sequence for any additional fault values. If timing type E1 (definite time delay), use formula:

$$Time_{delay} = \frac{11_{cycles}}{input_{frequency}}$$

If timing type D1 (inverse time delay), use formula:

$$Time_{delay} = Plot_{point} + \frac{3_{cycles}}{Input_{frequency}}$$

Depending on the timing type formula used, the PULSAR timer should equal the Time delay calculated for the BE1-81 .

5. To reset PULSAR to original default settings press RESET button on Input Power and Control Module.

Testing of General Electric Type CEB Relay

AVO
Multi-Amp

PULSAR

Date: September 30, 1993 Rev: A
IEEE Device Number: 21
Function: Distance Relay

This relay test sheet describes the use of the AVO Multi-Amp PULSAR test instrument to perform the CEB12B protective relay acceptance tests. Test connections to the AVO Multi-Amp PULSAR relay test set and manufacturer recommended relay settings are included.

References:

Manufacturer's Reference Literature

GEK-26240

Test Equipment
Instructional Material

PULSAR Operating Manual

Description of Relay

The CEB12 and CEB51 relays are single-phase, single zone, mho distance relay with provisions for offsetting the characteristic. The relays are designed primarily for use where one zone of back-up protection is required. Probably the most common application of the CEB relays is in generator back-up protection schemes where the relays are used to protect the generator from faults on the adjacent system which are not cleared by the first line relays.

PRECAUTIONS

*******WARNING*******

Dangerous and potentially fatal voltage can be developed across the output terminals of the PULSAR relay test set, refer to the PULSAR operation manual for further instructions.

Always turn the outputs **OFF** before connecting, removing or touching any output terminal or test lead, use extreme caution when turning on or using the PULSAR relay test set.

ALWAYS TEST THIS RELAY IN ITS CASE.

This relay is an out of step blocking relay. The relay will be tested with a single potential and a current source.

Test Connections:

Potentials: 17 and 18, polarity on 17.

Currents: Jumper 6-7, polarity on 5 and common on 8.

Contacts: 1 to 20, or 20 to the midpoint of the contact ring.

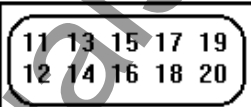

General Electric
CEB12 OR 51

[Front view of the relay with the test plugs inserted]

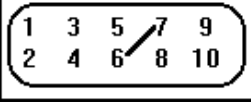

PULSAR

CONTROL MODULE	TIMER	VOLTS	VOLTS	VOLTS
		0 0↗	0 0↗	0 0↗
AMPS		AMPS		AMPS
0 0↗		0 0↗		0 0↗

ALWAYS REFER TO THE MANUFACTURERS' LITERATURE BEFORE TESTING!

Relay Notes:

SETUP AND PROCEDURE

For each test:

Assign current and voltage sources as indicated in the preset conditions table.

Execute the test as defined in the PULSAR CONDITIONS table.

Jumper relay terminals 6 to 7.

All test values are based upon a 60° maximum torque angle, 5Ω Reach, and the following formula:

$$Z = \frac{V}{2 \times I}$$

PULSAR TEST CONDITIONS						
ASSIGN	CONNECT		TEST	VALUES		HZ
	±	N			∠	
V _A	17	18	V _A	55	0°	60.0
I _A	5	8	I _A	5	60°	60.0
MON	1	20				

* = Value depends on offset tap

ALWAYS REFER TO THE MANUFACTURERS' LITERATURE BEFORE TESTING!

REACH TEST

1. Connect the Monitor circuit to the appropriate relay contacts.
2. Set I_A to 5A and 60°, set V_A to 55v and 0°, using the following keystrokes; **CURRENT, 1, AC, 5, PHASE, 60, VOLTAGE, 1, AC, 55, EXECUTE.**
3. Initiate PULSAR; **CURRENT, 1, ON, VOLTAGE, 1, ON, EXECUTE.** Using the appropriate Ramp Arrow keys ▲, ▼, ramp V_A until the contacts pickup.
4. Record the pickup value, refer to the CEB51 I.L. for any adjustment.
5. Turn I_A and V_A, OFF whenever an adjustment is required or the test is completed. **CURRENT, 1, VOLTAGE, 1, OFF, EXECUTE.**

MAXIMUM TORQUE ANGLE

Note: To determine maximum angle of torque, adjust the phase angle equidistance either side of the maximum angle of torque ($\pm 30^\circ$) and repeat the procedure used to determine the reach. The two points should be equal, if the maximum angle of torque is correct.

1. Set I_A to 5A and 90° , ($\pm 30^\circ$ of MTA), set V_A to 55v and 0° , using the following keystrokes; **CURRENT, 1, AC, 5, PHASE, 90, VOLTAGE, 1, AC, 55, EXECUTE.**
2. Initiate PULSAR; **CURRENT, 1, ON, VOLTAGE, 1, ON, EXECUTE.** Using the appropriate Ramp Arrow keys \blacktriangle , \blacktriangledown , ramp V_A until the contacts pickup.
3. Record the pickup value, refer to the CEB51 I.L. for any adjustment.
4. Turn I_A and V_A , OFF whenever an adjustment is required or the test is completed. **CURRENT, 1, VOLTAGE, 1, OFF, EXECUTE.**
5. Repeat the same test steps for the 30° angle ($\pm 30^\circ$ of MTA).

OFFSET

1. Set I_A to 5A and 240° , (180° opposite MTA), set V_A equal to (*)+10% above the expected pickup using the following keystrokes; **CURRENT, 1, AC, 5, PHASE, 240, VOLTAGE, 1, AC, (*), EXECUTE.**
2. Initiate PULSAR; **CURRENT, 1, ON, VOLTAGE, 1, ON, EXECUTE.**
3. Using the appropriate Ramp Arrow keys \blacktriangle , \blacktriangledown , ramp V_A until the contacts pickup.
4. Record the pickup value and refer to the CEB51 I.L. for any adjustment.
5. Turn V_A and I_A , OFF whenever an adjustment is required or the test is completed. **CURRENT, 1, VOLTAGE, 1, OFF, EXECUTE.**

Testing of General Electric Type CEY Relay

AVO
Multi-Amp

PULSAR

Date: September 30, 1993 Rev: A
IEEE Device Number: 21
Function: Distance Relay

This relay test sheet describes the use of the AVO Multi-Amp PULSAR test instrument to perform the CEY51A or CEY51B protective relay acceptance tests. Test connections to the AVO Multi-Amp PULSAR relay test set and manufacturer recommended relay settings are included.

References:

Manufacturer's Reference
Literature

GEK-1265

Test Equipment
Instructional Material

PULSAR Operating Manual

Description of Relay

The CEY51A and CEY51B relays are three-phase, high speed, single zone, mho distance relay with provisions for offsetting the characteristic. The relays are designed primarily for use where one zone of back-up protection is required. Probably the most common application of the CEY relays is in generator back-up protection schemes where the relays are used to protect the generator from faults on the adjacent system which are not cleared by the first line relays.

PRECAUTIONS

*******WARNING*******

Dangerous and potentially fatal voltage can be developed across the output terminals of the PULSAR relay test set, refer to the PULSAR operation manual for further instructions.

Always turn the outputs **OFF** before connecting, removing or touching any output terminal or test lead, use extreme caution when turning on or using the PULSAR relay test set.

ALWAYS TEST THIS RELAY IN ITS CASE.

This relay is a three phase,high speed, single zone mho directional relay.
 This relay will be tested with a single potential and current source.
 Potentials : Jumper 13-16-17,14-15,and 18-19-20. Phase A-B= 15-17, B-C = 17-19 C-A= 19-15.
 Currents : Jumper 6-8-10, Phase A-B= 5-7, B-C= 7-9, C-A = 9-5 contacts : 1 & 11, 2 & 11, 3 & 11.

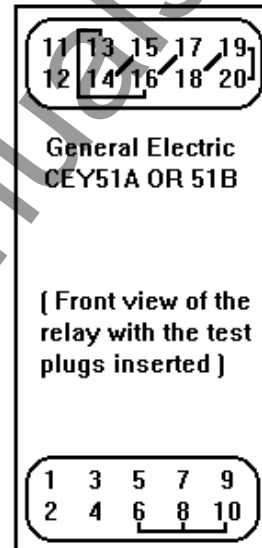

General Electric
 CEY51A OR 51B

[Front view of the relay with the test plugs inserted]

PULSAR

CONTROL MODULE	TIMER	VOLTS	VOLTS	VOLTS
		0 0↗	0 0↗	0 0↗
AMPS		AMPS		AMPS
0 0↗		0 0↗		0 0↗

ALWAYS REFER TO THE MANUFACTURERS' LITERATURE BEFORE TESTING!

Relay Notes:

SETUP AND PROCEDURE

For each test:

Assign current and voltage sources as indicated in the preset conditions table.

Execute the test as defined in the PULSAR CONDITIONS table.

Jumper relay terminals 6 to 8 to 10, 13 to 16 to 17, and 18 to 19 to 20.

All test values are based upon a 60° maximum torque angle, 5 Ω Reach, and the following formula:

$$Z = \frac{V}{2 \times I}$$

PULSAR TEST CONDITIONS						
ASSIGN	CONNECT		TEST	VALUES		HZ
	±	N			∠	
V _A	15	17	V _A	55	0°	60.0
I _A	5	7	I _A	5	60°	60.0
MON	1	11				
* = Value depends on offset tap						

ALWAYS REFER TO THE MANUFACTURERS' LITERATURE BEFORE TESTING!

REACH TEST 0 1-2

1. Connect the Monitor circuit to the appropriate relay contacts.
2. Set I_A to 5A and 60°, set V_A to 55v and 0°, using the following keystrokes; **CURRENT, 1, AC, 5, PHASE, 60, VOLTAGE, 1, AC, 55, EXECUTE.**
3. Initiate PULSAR; **CURRENT, 1, ON, VOLTAGE, 1, ON, EXECUTE.** Using the appropriate Ramp Arrow keys ▲, ▼, ramp V_A until the contacts pickup.
4. Record the pickup value, refer to the CEY51 I.L. for any adjustment.
5. Turn I_A and V_A, OFF whenever an adjustment is required or the test is completed. **CURRENT, 1, VOLTAGE, 1, OFF, EXECUTE.**

MAXIMUM TORQUE ANGLE Ø 1-2

Note: To determine maximum angle of torque, adjust the phase angle equidistance either side of the maximum angle of torque ($\pm 30^\circ$) and repeat the procedure used to determine the reach. The two points should be equal, if the maximum angle of torque is correct.

1. Set I_A to 5A and 90° , ($\pm 30^\circ$ of MTA), set V_A to 55v and 0° , using the following keystrokes; **CURRENT, 1, AC, 5, PHASE, 90, VOLTAGE, 1, AC, 55, EXECUTE.**
2. Initiate PULSAR; **CURRENT, 1, ON, VOLTAGE, 1, ON, EXECUTE.** Using the appropriate Ramp Arrow keys \blacktriangle , \blacktriangledown , ramp V_A until the contacts pickup.
3. Record the pickup value, refer to the CEY51 I.L. for any adjustment.
4. Turn I_A and V_A , OFF whenever an adjustment is required or the test is completed. **CURRENT, 1, VOLTAGE, 1, OFF, EXECUTE.**
5. Repeat the same test steps for the 30° angle ($\pm 30^\circ$ of MTA).

NOTE: Repeat the same test steps for Ø 2-3, and Ø 3-1.
Connections will vary so refer to the CEY51 I.L.

OFFSET

1. Set I_A to 5A and 240° , (180° opposite MTA), set V_A equal to (*)+10% above the expected pickup using the following keystrokes; **CURRENT, 1, AC, 5, PHASE, 240, VOLTAGE, 1, AC, (*), EXECUTE.**
2. Initiate PULSAR; **CURRENT, 1, ON, VOLTAGE, 1, AC, ON, EXECUTE.**
3. Using the appropriate Ramp Arrow keys \blacktriangle , \blacktriangledown , ramp V_A until the contacts pickup.
4. Record the pickup and refer to the CEY51 I.L. for any adjustment.
5. Turn V_A and I_A , OFF whenever an adjustment is required or the test is completed; **CURRENT, 1, VOLTAGE, 1, OFF, EXECUTE.**

Testing of Westinghouse Type CF-1 Relay

AVO
Multi-Amp

PULSAR

Date: September 30, 1993 Rev: B
IEEE Device Number: 81
Function: Frequency Relay

This relay test sheet describes the use of the AVO Multi-Amp PULSAR test instrument to perform the CF-1 protective relay acceptance tests. Test connections to the AVO Multi-Amp PULSAR relay test set and manufacturer recommended relay settings are included.

References:

Manufacturer's Reference
Literature

I.L. 41-501.2F

Test Equipment
Instructional Material

PULSAR Operating Manual

Description of Relay

The CF-1 is a single phase induction disk relay used in protection schemes against the effects of overfrequency or underfrequency.

PRECAUTIONS

*******WARNING*******

Dangerous and potentially fatal voltage can be developed across the output terminals of the PULSAR relay test set, refer to the PULSAR operation manual for further instructions.

Always turn the outputs **OFF** before connecting, removing or touching any output terminal or test lead, use extreme caution when turning on or using the PULSAR relay test set.

ALWAYS TEST THIS RELAY IN ITS CASE.

The CF-1 is a single phase induction disk relay used in protection schemes against the effects of overfrequency or underfrequency.

Test Connections:

Frequency sensing: 9 and 8, polarity on 9.

Contacts: 1 and 10.

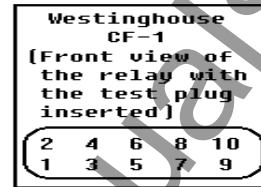

PULSAR

CONTROL MODULE	TIMER	VOLTS	VOLTS	VOLTS
		0 0↘	0 0↘	0 0↘
AMPS		AMPS		AMPS
0 0↘		0 0↘		0 0↘

ALWAYS REFER TO THE MANUFACTURERS' LITERATURE BEFORE TESTING!

Relay Notes:

SETUP AND PROCEDURE

For each test:

The CF-1 relay is available as either an overfrequency and underfrequency characteristics. The underfrequency setting is 59 Hz and the overfrequency setting is 62 Hz.

Assign voltage sources as indicated in the preset conditions table.

Underfrequency Test

PULSAR TEST CONDITIONS						
ASSIGN	CONNECT		TEST	VALUES		HZ
	±	N			∠	
V _A	9	8	V _A	115	0°	60.0
MON	10	1				

MINIMUM PICKUP TEST

1. Set V_A equal to test parameters and initiate; **VOLTAGE, 1, AC, 115, ON, Shift, SZ, FREQ, EXECUTE.**
2. Using Ramp Arrow keys ramp V_A frequency down until main trip contacts pickup.
3. Record the minimum pickup value.
4. De-initiate V_A; **VOLTAGE, 1, OFF, EXECUTE.**

TIMING TEST

1. Set V_A to normal voltage and frequency; **VOLTAGE, 1, AC, 115, FREQ, 60, ON, Shift, SZ, EXECUTE.**
2. Move monitor circuit to timer stop gate.
3. Set V_A equal to fault voltage and fault frequency i. e., 59 Hz and set output to turn off when relay trips and stop timer using the following key strokes; **VOLTAGE, 1, AC, 115, FREQ, 59, Shift, A-OFF, ON, TIMER START, EXECUTE.**
4. Record the timing value. Repeat testing sequence for any additional fault voltage and frequency values.
5. To reset PULSAR to original default settings press RESET button on Input Power and Control Module.

Overfrequency Test

PULSAR TEST CONDITIONS						
ASSIGN	CONNECT		TEST	VALUES		HZ
	±	N			∠	
V _A	9	8	V _A	115	0°	60.0
MON	10	1				

MINIMUM PICKUP TEST

1. Set V_A equal to test parameters and initiate; **VOLTAGE, 1, AC, 115, ON, FREQ, Shift, SZ, EXECUTE.**
2. Using Ramp Arrow keys ramp V_A frequency up until main trip contacts pickup.
3. Record the minimum pickup value.
4. De-initiate V_A; **VOLTAGE, 1, OFF, EXECUTE.**

TIMING TEST

1. Set V_A to normal voltage and frequency; **VOLTAGE, 1, AC, 115, FREQ, ON, Shift, SZ, EXECUTE.**
2. Move monitor circuit to timer stop gate.
3. Set V_A equal to fault voltage and fault frequency i. e., 62 Hz and set output to turn off when relay trips and stop timer using the following keystrokes; **VOLTAGE, 1, AC, 110, FREQ, 62, Shift, A-OFF, ON, TIMER START, EXECUTE.**
4. Record the timing pickup value. Repeat testing sequence for any additional fault values.
5. To reset PULSAR to original default settings, press RESET button on Input Power and Control Module.

Testing of General Electric Type CHC11 Relay

AVO
Multi-Amp

PULSAR

Date: September 30, 1993 Rev: B
IEEE Device Number: 50
Function: Instantaneous Overcurrent Fault Detector

This relay test sheet describes the use of the AVO Multi-Amp PULSAR test instrument to perform the CHC11A21 and CHC11B11 protective relay acceptance tests. Test connections to the AVO Multi-Amp PULSAR relay test set and manufacturer recommended relay settings are included.

References:

Manufacturer's Reference
Literature

GEK-1253D

Test Equipment
Instructional Material

PULSAR Operating Manual

Description of Relay

The CHC11A and CHC11B relays are a complete three-phase and ground, multi-contact, high speed nondirectional overcurrent relay. The CHC11 consists of an induction cup unit for multi-phase faults and a small hinged armature unit for ground faults. The CHC11B is similar to the CHC11A except that the CHC11B has a dual rated auxiliary telephone relay "A" unit. The CHC11A and CHC11B relays may be applied wherever a high-speed fault detector is required.

PRECAUTIONS

*******WARNING*******

Dangerous and potentially fatal voltage can be developed across the output terminals of the PULSAR relay test set, refer to the PULSAR operation manual for further instructions.

Always turn the outputs **OFF** before connecting, removing or touching any output terminal or test lead, use extreme caution when turning on or using the PULSAR relay test set.

ALWAYS TEST THIS RELAY IN ITS CASE.

The CHC11A and CHC11B relays are a complete three-phase and ground, multi-contact, high speed nondirectional overcurrent relay.

Test Connections:

Jumper 4 to 6, for PFD test only.
 Current: PFD, 3 and 5, GFD, 14 and 15.
 Contacts: 1 and 12, 2 and 16.

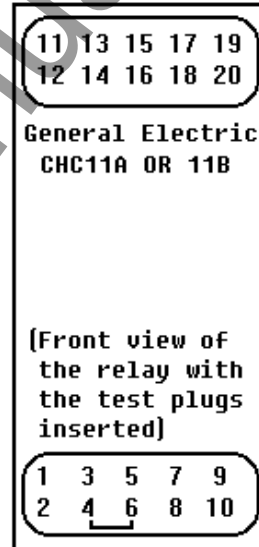

PULSAR

CONTROL MODULE	TIMER	VOLTS	VOLTS	VOLTS
		0 0↗	0 0↗	0 0↗
AMPS		AMPS		AMPS
0 0↗		0 0↗		0 0↗

ALWAYS REFER TO THE MANUFACTURERS' LITERATURE BEFORE TESTING!

Relay Notes:

SETUP AND PROCEDURE

For each test:

Assign current and voltage sources as indicated in the preset conditions table.

Jumper relay terminals 4 to 6.

PULSAR TEST CONDITIONS						
ASSIGN	CONNECT		TEST	VALUES		HZ
	\pm	N			\angle	
I_A	3	5	I_A	0.5	0°	60.0
I_B	14	15	I_B	0.5	0°	60.0
MON	1	12				

$I_A = \text{PFD}$ and $I_B = \text{GFD}$

PFD - MINIMUM PICKUP

1. Set PULSAR current (I_A) equal to tap value; **CURRENT, 1, AC, 0.5, EXECUTE.**
2. Turn current (I_A) ON; **ON, EXECUTE.** Using Ramp Arrow keys ramp current channel up or down to find minimum pickup.
3. Minimum pickup should be within $\pm 10\%$ of tap value. Refer to relay instruction manual for adjustment to relay.

GFD - MINIMUM PICKUP

1. Connect monitor circuit to relay binding posts 2 and 16.
2. Set PULSAR current (I_B) equal to tap value; **CURRENT, 1, AC, 0.5, EXECUTE.**
3. Turn current (I_B) ON; **ON, EXECUTE.** Using Ramp Arrow keys ramp current channel up or down to find minimum pickup.
4. Minimum pickup should be within $\pm 10\%$ of tap value. Refer to relay instruction manual for adjustment to relay.

Testing of Westinghouse Type CO Relay

AVO
Multi-Amp

PULSAR

Date: September 30, 1993 Rev: B
IEEE Device Number: 51
Function: Overcurrent

This relay test sheet describes the use of the AVO Multi-Amp PULSAR test instrument to perform the CO protective relay acceptance tests. Test connections to the AVO Multi-Amp PULSAR relay test set and manufacturer recommended relay settings are included.

References:

Manufacturer's Reference
Literature

I.L. 41-101-Q

Test Equipment
Instructional Material

PULSAR Operating Manual

Description of Relay

The CO is an induction type single-phase, non directional overcurrent relay. The CO is primarily used as phase or ground overcurrent protection of feeders, transmission lines, ac generators, transformers, capacitors, reactors, and other application where a relay is required whose operating time inversely is related to operating current.

PRECAUTIONS

*******WARNING*******

Dangerous and potentially fatal voltage can be developed across the output terminals of the PULSAR relay test set, refer to the PULSAR operation manual for further instructions.

Always turn the outputs **OFF** before connecting, removing or touching any output terminal or test lead, use extreme caution when turning on or using the PULSAR relay test set.

ALWAYS TEST THIS RELAY IN ITS CASE.

SETUP AND PROCEDURE

For each test:

The CO relay test is generic, the test parameters are 2A tap and 20A instantaneous unit. Your tap values may be different. Some relays may require that current channels be paralleled to increase VA or total current, i.e., 40 A instantaneous will require two current channels 20 amperes each (see Operating Procedures, Section 1.1, Current Sources - Parallel Operation). If more current or Volt-Amperes are needed, see Description of Controls, paragraph 1.6, High Current Interface Module and EPOCH-20/II Specifications. Assign current sources as indicated in the preset conditions table.

PULSAR TEST CONDITIONS						
ASSIGN	CONNECT		TEST	VALUES		HZ
	±	N			∠	
I _A	9	8	I _A	2	0°	60.0
MON	10	1				

MINIMUM PICKUP TEST

1. Set I_A equal to tap value; **CURRENT, 1, AC, 2, ON, EXECUTE**. Note that disk is starting to creep.
2. Using the Ramp Arrow keys ramp I_A up or down to determine minimum pickup value.
3. Record the minimum pickup value.
4. De-initiate I_A; **CURRENT, 1, OFF, EXECUTE**.

TIMING TEST

1. Move monitor circuit to timer stop gate (Timer Terminal 2).
2. Set I_A equal to fault current level(s) i.e., 2X; **CURRENT, 1, AC, 4, ON, Shift, A-OFF, ON, TIMER START, EXECUTE**.
3. Upon contact closure of CO contacts the Timer should stop and output turn off. Record the trip time.

INSTANTANEOUS TEST

1. Move monitor circuit to terminals 10 and 2.

2. Set I_A equal to 20A ; **CURRENT, 1, AC, 20, Shift, A-OFF, ON, EXECUTE.**
3. Turn I_A ON; **CURRENT, 1, ON, EXECUTE.** Pulse I_A up or down until main trip contacts pickup, using the incremental steps of 1A RAMP Key 1 and the **OFF, EXECUTE, ON, EXECUTE** sequential commands. When relay operates, the output will automatically turn off.
4. Record pickup value. Reset A-OFF; **Shift, A-OFF, OFF, EXECUTE.**

Testing of Westinghouse Type CRN-1 Relay

AVO
Multi-Amp

PULSAR

Date: September 30, 1993 Rev: B
IEEE Device Number: 32
Function: Directional Power

This relay test sheet describes the use of the AVO Multi-Amp PULSAR test instrument to perform the CRN-1 protective relay acceptance tests. Test connections to the AVO Multi-Amp PULSAR relay test set and manufacturer recommended relay settings are included.

References:

Manufacturer's Reference
Literature

I.L. 41-251.2K

Test Equipment
Instructional Material

PULSAR Operating Manual

Description of Relay

The CRN-1 relay is a single phase directionally controlled timing relay used to protect ac generators from motoring. When such a condition occurs and persists for a predetermined time interval, the generator may be tripped or an alarm sounded.

PRECAUTIONS

*******WARNING*******

Dangerous and potentially fatal voltage can be developed across the output terminals of the PULSAR relay test set, refer to the PULSAR operation manual for further instructions.

Always turn the outputs **OFF** before connecting, removing or touching any output terminal or test lead, use extreme caution when turning on or using the PULSAR relay test set.

ALWAYS TEST THIS RELAY IN ITS CASE.

The CRN-1 relay is a single phase direction-ally controlled timing relay used to protect a-c generators from motoring. The relay consists of a directional unit and a timing unit.

Test Connections:

Potentials: 6 and 7, polarity on 6.
 Currents: 8 and 9, polarity on 9.
 Contacts: 1 and 10.

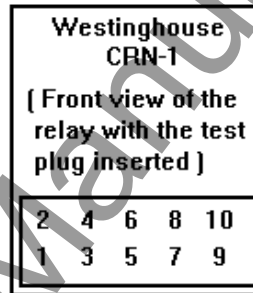

PULSAR

CONTROL MODULE	TIMER	VOLTS	VOLTS	VOLTS
		0 0↗	0 0↗	0 0↗
AMPS		AMPS		AMPS
0 0↗		0 0↗		0 0↗

ALWAYS REFER TO THE MANUFACTURERS' LITERATURE BEFORE TESTING!

Relay Notes:

SETUP AND PROCEDURE

For each test:

Assign current and voltage sources as indicated in the preset conditions table.

PULSAR TEST CONDITIONS						
ASSIGN	CONNECT		TEST	VALUES		HZ
	±	N			∠	
V _A	6	7	V _A	*	0°	60.0
MON	10	1				

MINIMUM PICKUP

1. Block directional unit contacts closed.
2. Set V_A equal to 50% of rated voltage; **VOLTAGE, 1, AC, 60, EXECUTE.**
3. Initiate V_A ON; **ON, EXECUTE.** Using Ramp Arrow keys ramp V_A up or down to find minimum pickup.
4. Minimum pickup should be within ±3% of acceptance value where:
Minimum Pickup = (54% * Rated Voltage).
5. De-initiate V_A; **OFF, EXECUTE.**
6. Refer to relay instruction manual for adjustment to relay for minimum pickup.

TIMING TEST

1. Block directional unit contacts closed.
2. Move monitor terminals to timer stop gate binding post (Timer Terminal 2).
3. Set V_A equal to desired test voltage (i.e. 120 volts) and test to find correct timing value; **VOLTAGE, 1, AC, 120, ON, Shift, A-OFF, ON, TIMER START, EXECUTE.**
4. When relay trips, output will turn off and Timer will stop. Repeat test for other voltage values.
5. Timing accuracy should be within ±5% of rated fault values. Refer to relay instruction manual for adjustment to relay for assure accurate timing.

PULSAR TEST CONDITIONS						
ASSIGN	CONNECT		TEST	VALUES		HZ
	±	N			∠	
V _A	6	7	V _A	120	0°	60.0
I _A	9	8	I _A	4	0°	60.0
MON	10	1				

DIRECTIONAL UNIT, MAXIMUM TORQUE ANGLE

1. Set V_A to rated voltage at 0°, turn VA ON; **VOLTAGE, 1, AC, 120, ON, EXECUTE.**
2. Set I_A to 4 amperes at 0°; **CURRENT, 1, AC, 4, EXECUTE.**
3. Initiate I_A ON; **CURRENT, 1, ON, EXECUTE.** CRN-1 relay contacts should be closed. Adjust (I_A) phase angle to 240° (current leads voltage 120°); **CURRENT, 1, PHASE, 240, EXECUTE.** Relay contacts should be closed. Using Ramp Arrow keys, an increase of 1° leading, (239°), should cause the CRN-1 contacts to open. If contacts open greater than 1°, adjustment is required. Refer to instruction manual for proper adjustment to the back resistor.
4. De-initiate PULSAR current and voltage channels; **VOLTAGE, 1, CURRENT, 1, OFF, EXECUTE.** Perform this sequence whenever adjustment to relay is required or when test is completed.

DIRECTIONAL UNIT, SENSITIVITY

1. Set PULSAR voltage channel V_A to rated voltage at 0°, turn V_A ON; **VOLTAGE, 1, AC, 120, ON, EXECUTE.**
2. Set current I_A to 330° and turn current ON; **CURRENT, 1, PHASE, 330, AC, 0, ON, EXECUTE.** Using Ramp Arrow keys ramp current up from 0.0 amps at 330° until CRN-1 relay contacts close. Record this current reading. Typical pickup value is .020 Amperes.
3. De-initiate PULSAR current and voltage channels; **CURRENT, 1, VOLTAGE, 1, OFF, EXECUTE.**

Testing of Westinghouse CV Relay

AVO
Multi-Amp

PULSAR

Date: September 30, 1993 Rev: B
IEEE Device Number: 59
Function: Overvoltage Relay

This relay test sheet describes the use of the AVO Multi-Amp PULSAR test instrument to perform the CV protective relay acceptance tests. Test connections to the AVO Multi-Amp PULSAR relay test set and manufacturer recommended relay settings are included.

References:

Manufacturer's Reference
Literature

I.L. 41-201.2D

Test Equipment
Instructional Material

PULSAR Operating Manual

Description of Relay

The CV is a single phase overvoltage relay used in protection schemes for sensitive overvoltage or undervoltage ground detection for high impedance grounded generators or for ungrounded power systems.

PRECAUTIONS

*******WARNING*******

Dangerous and potentially fatal voltage can be developed across the output terminals of the PULSAR relay test set, refer to the PULSAR operation manual for further instructions.

Always turn the outputs **OFF** before connecting, removing or touching any output terminal or test lead, use extreme caution when turning on or using the PULSAR relay test set.

ALWAYS TEST THIS RELAY IN ITS CASE.

SETUP AND PROCEDURE

For each test:

Assign current and voltage sources as indicated in the preset conditions table.

PULSAR TEST CONDITIONS						
ASSIGN	CONNECT		TEST	VALUES		HZ
	±	N			∠	
V _A	9	8	V _A	55	0°	60.0
MON	10	1				

MINIMUM PICKUP TEST

1. Set V_A equal to test parameters and initiate; **VOLTAGE, 1, AC, 55, ON, EXECUTE.**
2. Using Ramp Arrow keys ramp V_A up or down until main trip contacts pickup.
3. Record the minimum pickup value.
4. De-initiate V_A; **VOLTAGE, 1, OFF, EXECUTE.**

TIMING TEST

1. Set V_A to normal voltage i.e., 55 volts; **VOLTAGE, 1, AC, 55, ON, EXECUTE.**
2. Move monitor circuit to timer stop gate.
3. Set V_A equal to fault voltage at 110%; **VOLTAGE, 1, AC, 60.5, ON, Shift, A-OFF, ON, TIMER START, EXECUTE.**
4. When relay trips, it will stop the Timer and turn outputs off. Record the timing pickup value. Repeat testing sequence for any additional fault values. Reset A-OFF; **Shift, A-OFF, OFF, EXECUTE.**

Testing of Westinghouse Type CVE Relay

AVO
Multi-Amp

PULSAR

Date: September 30, 1993 Rev: B
IEEE Device Number: 25
Function: Synchronizing

This relay test sheet describes the use of the AVO Multi-Amp PULSAR test instrument to perform the CVE and CVE-1 protective relay acceptance tests. Test connections to the AVO Multi-Amp PULSAR relay test set and manufacturer recommended relay settings are included.

References:

Manufacturer's Reference
Literature

I.L. 41-681.P

Test Equipment
Instructional Material

PULSAR Operating Manual

Description of Relay

The CVE is a synchro-verifier relay and the CVE-1 is a synchro-verifier relay with line and bus voltage sensing relays. The synchro-verifier is used to verify the condition of synchronism existing between two system voltages. The relay's contacts will close when these voltages are within the relay's set limits.

PRECAUTIONS

*******WARNING*******

Dangerous and potentially fatal voltage can be developed across the output terminals of the PULSAR relay test set, refer to the PULSAR operation manual for further instructions.

Always turn the outputs **OFF** before connecting, removing or touching any output terminal or test lead, use extreme caution when turning on or using the PULSAR relay test set.

ALWAYS TEST THIS RELAY IN ITS CASE.

The CVE is a synchro-verifier relay.
 This relay will require two potentials with
 phase shifting capability.

Test Connections:

Potentials: 6 and 7, polarity on 7. 8 and 9
 polarity on 9.

Contacts: 1 and 10

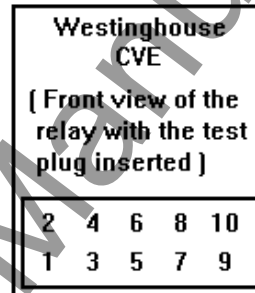

PULSAR

CONTROL MODULE	TIMER	VOLTS	VOLTS	VOLTS
		0 0↘	0 0↘	0 0↘
AMPS		AMPS		AMPS
0 0↘		0 0↘		0 0↘

**ALWAYS REFER TO THE MANUFACTURERS' LITERATURE
 BEFORE TESTING!**

Relay Notes:

SETUP AND PROCEDURE

For each test:

Assign voltage sources as indicated in the preset conditions table. The test values are based upon a 20° closing angle relay setting.

PULSAR TEST CONDITIONS						
ASSIGN	CONNECT		TEST	VALUES		HZ
	±	N			∠	
V _A	6	7	V _A	120	0°	60.0
V _B	9	8	V _B	120	0°	60.0
MON	10	1				

CENTERING CIRCLE (CVE)

1. Set PULSAR voltage channel V_A and V_B to rated voltage at 0°, turn V_A and V_B ON; **VOLTAGE, 1, 2, AC, 120, ON, EXECUTE.**
2. Using the Ramp Arrow keys ramp the phase angle for V_B in the lagging direction, (0° to 20°); **VOLTAGE, 2, PHASE, EXECUTE** until the contacts open, record this value. Ramp the phase angle in the, opposite, leading direction, (0° to 340°), until the contacts open a second time, record this value.
3. If the two angles are not within ±1° of each other, adjustment must be made to center the CVE. Refer to instruction manual for proper adjustment to the resistor.
4. De-initiate PULSAR; **VOLTAGE, 1, 2, OFF, EXECUTE** whenever adjustment is required to the relay or the test is completed.

TIMING TEST

1. Move monitor circuit to timer stop gate on PULSAR.
2. Set PULSAR voltage channels V_A and V_B to rated voltage at 0°; **VOLTAGE, 1, 2, AC, 120, PHASE, 0, ON, Shift, A-OFF, ON, TIMER START, EXECUTE.**
3. When relay trips, Timer will stop and outputs will turn off. Record timing value.
4. Repeat test as necessary.

PULSAR TEST CONDITIONS						
ASSIGN	CONNECT		TEST	VALUES		HZ
	±	N			∠	
V _A	5&7	4	V _A	120	0°	60.0
V _B	6	8	V _B	120	0°	60.0
MON	10	1				

CENTERING CIRCLE (CVE-1) without COMMONED POTENTIAL COILS

1. Set PULSAR voltage channel V_A and V_B to rated voltage at 0°, turn V_A and V_B ON; **VOLTAGE, 1, 2, AC, 120, ON, EXECUTE.**
2. Using the Ramp Arrow keys ramp the phase angle for V_B in the lagging direction, (0° to 20°), **VOLTAGE, 2, PHASE, EXECUTE**, until the contacts open, record this value. Ramp the phase angle in the, opposite, leading direction, (0° to 340°), until the contacts open a second time, record this value.
3. If the two angles are not within ±1° of each other, adjustment must be made to center the CVE. Refer to instruction manual for proper adjustment to the resistor.
4. De-initiate PULSAR whenever adjustment is necessary or when test is completed; **VOLTAGE, 1, 2, OFF, EXECUTE.**

TIMING TEST

1. Move monitor circuit to timer stop gate on PULSAR.
2. Set PULSAR voltage channels V_A and V_B to rated voltage at 0°; **VOLTAGE, 1, 2, AC, 120, PHASE, 0, ON, Shift, A-OFF, ON, TIMER START, EXECUTE.**
3. When relay trips, Timer will stop and outputs will turn off. Record timing value.
4. Repeat test as necessary.

Testing of General Electric Type GCX Relay

AVO
Multi-Amp

PULSAR

Date: September 30, 1993 Rev: B
IEEE Device Number: 21
Function: Distance Relay

This relay test sheet describes the use of the AVO Multi-Amp PULSAR test instrument to perform the GCX51A and GCX51B protective relay acceptance tests. Test connections to the AVO Multi-Amp PULSAR relay test set and manufacturer recommended relay settings are included.

References:

Manufacturer's Reference
Literature

GEI-98328

Test Equipment
Instructional Material

PULSAR Operating Manual

Description of Relay

The GCX51A and GCX51B relays are single-phase, three-zone phase distance relays. The first and second zone distance measurements are made by a unit having a reactance or ohm characteristic while the third zone has a directional mho characteristic. The GCX51A and GCX51B relays are identical except that the GCX51B contains an instantaneous overcurrent fault detector while the GCX51A does not.

PRECAUTIONS

*******WARNING*******

Dangerous and potentially fatal voltage can be developed across the output terminals of the PULSAR relay test set, refer to the PULSAR operation manual for further instructions.

Always turn the outputs **OFF** before connecting, removing or touching any output terminal or test lead, use extreme caution when turning on or using the PULSAR relay test set.

ALWAYS TEST THIS RELAY IN ITS CASE.

The GCX51A and GCX51B relays are single phase, three zone phase distance relays. This relay will be tested with a single potential and a current source.

Test Connections:

Potentials: 17 and 18, polarity on 17.
 Currents: Jumper 7 to 8, in 5 and out (common) 10.

Contacts: Z1, 1 and 11, Z2, 2 and 11, Z3, 3 and 11.

OX unit: 12 (+) and 13 (-) for Z2 p.u.

GCX51B Overcurrent

Current: 5 and 6.

Contacts: 2 and 11.

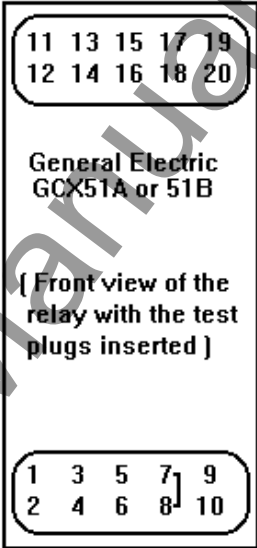

PULSAR

CONTROL MODULE	TIMER	VOLTS	VOLTS	VOLTS
		0 0↗	0 0↗	0 0↗
AMPS		AMPS		AMPS
0 0↗		0 0↗		0 0↗

ALWAYS REFER TO THE MANUFACTURERS' LITERATURE BEFORE TESTING!

Relay Notes:

SETUP AND PROCEDURE

For each test:

Assign current and voltage sources as indicated in the preset conditions table.

Execute the test as defined in the PULSAR CONDITIONS table.

Jumper relay terminals 7 to 8.

All test values are based upon a 60° maximum torque angle and the following formula:

$$Z = \frac{V}{2 \times I}$$

PULSAR TEST CONDITIONS						
ASSIGN	CONNECT		TEST	VALUES		HZ
	±	N			∠	
V _A	17	18	V _A	35	0°	60.0
I _A	5	10	I _A	5	60°	60.0
MON	*	*				
Z1 = 3Ω		Z2 = 4Ω		Z3 = 5Ω		

OHMIC REACH-ZONE 1

1. Connect the Monitor circuit to the appropriate relay contacts.
2. Set I_A to 5A and 60°, set V_A to 35v and 0°, using the following keystrokes; **CURRENT, 1, AC, 5, PHASE, 60, VOLTAGE, 1, AC, 35, EXECUTE.**
3. Initiate PULSAR; **CURRENT, 1, ON, VOLTAGE, 1, ON, EXECUTE.** Using the appropriate Ramp Arrow keys ▲, ▼, ramp V_A until the contacts pickup.
4. Record the pickup value, refer to the GCX51 I.L. for any adjustment.
5. Turn I_A and V_A, OFF whenever an adjustment is required or the test is completed. **CURRENT, 1, VOLTAGE, 1, OFF, EXECUTE.**

OHMIC MAXIMUM TORQUE ANGLE-ZONE 1

Note: To determine maximum angle of torque, adjust the phase angle equidistance either side of the maximum angle of torque ($\pm 30^\circ$) and repeat the procedure used to determine the reach. The two points should be equal, if the maximum angle of torque is correct.

1. Set I_A to 5A and 90° , ($\pm 30^\circ$ of MTA), set V_A to 35v and 0° , using the following keystrokes; **CURRENT, 1, AC, 5, PHASE, 90, VOLTAGE, 1, AC, 35, EXECUTE.**
2. Initiate PULSAR; **CURRENT, 1, ON, VOLTAGE, 1, ON, EXECUTE.** Using the appropriate Ramp Arrow keys \blacktriangle , \blacktriangledown , ramp V_A until the contacts pickup.
3. Record the pickup value, refer to the GCX51 I.L. for any adjustment.
4. Turn I_A and V_A , OFF whenever an adjustment is required or the test is completed. **CURRENT, 1, VOLTAGE, 1, OFF, EXECUTE.**
5. Repeat the same test steps for the 30° angle ($\pm 30^\circ$ of MTA).

PULSAR TEST CONDITIONS						
ASSIGN	CONNECT		TEST	VALUES		HZ
	\pm	N		\angle		
V_A	17	18	V_A	45	0°	60.0
I_A	5	10	I_A	5	60°	60.0
MON	*	*				
Z1 = 3Ω		Z2 = 4Ω	Z3 = 5Ω			

OHMIC REACH-ZONE 2

1. Connect the monitor circuit to the appropriate relay contacts.
2. Manually close the OX unit or connect 125 vdc to terminals 12 (+) and 13 (-) to pickup the OX unit needed to do the Zone 2 tests.
3. Set I_A to 5A and 60° , set V_A to 45v and 0° , using the following keystrokes; **CURRENT, 1, AC, 5, PHASE, 60, VOLTAGE, 1, AC, 45, EXECUTE.**
4. Initiate PULSAR; **CURRENT, 1, ON, VOLTAGE, 1, ON, EXECUTE.** Using the appropriate Ramp Arrow keys, \blacktriangle , \blacktriangledown , ramp V_A until the contacts pickup.
5. Record the pickup value, refer to the GCX51 I.L. for an adjustment.
6. Turn I_A and V_A OFF, whenever an adjustment is required or the test is completed. **CURRENT, 1, VOLTAGE, 1, OFF, EXECUTE.**

OHMIC MAXIMUM TORQUE ANGLE-ZONE 2

Note: To determine maximum angle of torque, adjust the phase angle equidistance either side of the maximum angle of torque ($\pm 30^\circ$ of MTA) and repeat the procedure used to determine reach. The two points should be equal, if the maximum angle of torque is correct.

1. Set I_A to 5A and 90° ($\pm 30^\circ$ of MTA), set V_A to 45v and 0° , using the following keystrokes; **CURRENT, 1, AC, 5, PHASE, 90, VOLTAGE, 1, AC, 45, EXECUTE.**
2. Initiate PULSAR; **CURRENT, 1, ON, VOLTAGE, 1, ON, EXECUTE.** Using the appropriate Ramp Arrow keys, **▲, ▼**, ramp V_A until the contacts pickup.
3. Record the pickup value, refer to the GCX51 I.L. for any adjustment.
4. Turn I_A and V_A OFF, whenever an adjustment is required or the test is completed. **CURRENT, 1, VOLTAGE, 1, OFF, EXECUTE.**
5. Repeat the same test steps for the 30° angle ($\pm 30^\circ$ of MTA).

PULSAR TEST CONDITIONS						
ASSIGN	CONNECT		TEST	VALUES		HZ
	\pm	N			\angle	
V_A	17	18	V_A	55	0°	60.0
I_A	5	10	I_A	5	60°	60.0
MON	*	*				
Z1 = 3Ω Z2 = 4Ω Z3 = 5Ω						

OHMIC REACH - MHO UNIT

1. Connect the Monitor circuit to the appropriate relay contacts.
2. Set I_A to 5A and 60° , set V_A to 55V and 0° , using the following keystrokes; **CURRENT, 1, AC, 5, PHASE, 60, VOLTAGE, 1, AC, 55, EXECUTE.**
3. Initiate PULSAR; **CURRENT, 1, ON, VOLTAGE, 1, ON, EXECUTE.** Using the appropriate Ramp Arrow keys **▲, ▼**, ramp V_A until the contacts pickup.
4. Record the pickup value, refer to the GCX51 I.L. for any adjustment.
5. Turn I_A and V_A , OFF whenever an adjustment is required or the test is completed. **CURRENT, 1, VOLTAGE, 1, OFF, EXECUTE.**

MAXIMUM TORQUE ANGLE - MHO UNIT

Note: To determine maximum angle of torque, adjust the phase angle equidistance either side of the maximum angle of torque ($\pm 30^\circ$ of MTA) and repeat the procedure used to determine reach. The two points should be equal, if the maximum angle of torque is correct.

1. Set I_A to 5A and 90° , ($\pm 30^\circ$ of MTA), set V_A to 55V and 0° , using the following keystrokes; **CURRENT, 1, AC, 5, PHASE, 90, VOLTAGE, 1, AC, 55, EXECUTE.**
2. Initiate PULSAR; **CURRENT, 1, ON, VOLTAGE, 1, ON, EXECUTE.** Using the appropriate Ramp Arrow keys \blacktriangle , \blacktriangledown , ramp V_A until the contacts pickup.
3. Record the pickup value, refer to the GCX51 I.L. for any adjustment.
4. Turn I_A and V_A , OFF whenever an adjustment is required or the test is completed. **CURRENT, 1, VOLTAGE, 1, OFF, EXECUTE.**
5. Repeat the same test steps for the 30° angle ($\pm 30^\circ$ of MTA).

OVERCURRENT UNIT PICKUP - GCX51B

1. Connect I_A to GCX51B relay terminals 5 and 6 respectively.
2. Connect monitor binding posts to relay terminals 2 and 11.
3. Set I_A equal to tap value at 0° and initiate I_A ; **CURRENT, 1, PHASE, 0, AC, 5, ON, EXECUTE.**
4. Using the Ramp Arrow keys ramp current up or down to find minimum pickup.
5. Record value and refer to GCX51B instruction manual for adjustment.
6. De-initiate PULSAR; **CURRENT, 1, OFF, EXECUTE.**

Testing of General Electric Type GCY Relay

AVO
Multi-Amp

PULSAR

Date: September 30, 1993 Rev: A
IEEE Device Number: 21
Function: Distance Relay

This relay test sheet describes the use of the AVO Multi-Amp PULSAR test instrument to perform the GCY51A protective relay acceptance tests. Test connections to the AVO Multi-Amp PULSAR relay test set and manufacturer recommended relay settings are included.

References:

Manufacturer's Reference
Literature

GEI-98338

Test Equipment
Instructional Material

PULSAR Operating Manual

Description of Relay

The GCY51 relay is a single-phase, three zone, expanded range, directional mho step distance relay for transmission line protection, phase distance relays. The GCY51 relay is used in combination with other relays and pilot channels to provide high speed protection in directional comparison and transferred tripping schemes.

PRECAUTIONS

*******WARNING*******

Dangerous and potentially fatal voltage can be developed across the output terminals of the PULSAR relay test set, refer to the PULSAR operation manual for further instructions.

Always turn the outputs **OFF** before connecting, removing or touching any output terminal or test lead, use extreme caution when turning on or using the PULSAR relay test set.

ALWAYS TEST THIS RELAY IN ITS CASE.

The GCY is a single phase, three zone directional mho step distance relay. This relay will be tested with a single potential and a current source. Potentials: Jumper 17-19,18-20 polarity on 17. Currents: Jumper 4-5,6-7,8-9, polarity on 3 and out (common) on 10. contacts: M1 - 1 to 11, M2 - 2 to 11, and M3 - 11 to 12.

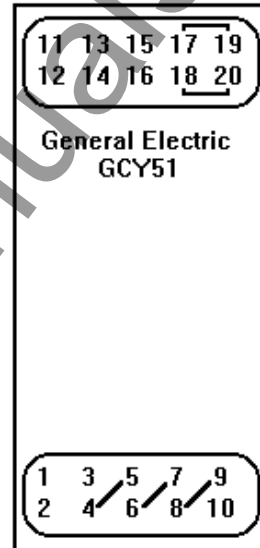

PULSAR

CONTROL MODULE	TIMER	VOLTS	VOLTS	VOLTS
		0 0↘	0 0↘	0 0↘
AMPS		AMPS		AMPS
0 0↘		0 0↘		0 0↘

ALWAYS REFER TO THE MANUFACTURERS' LITERATURE BEFORE TESTING!

Relay Notes:

SETUP AND PROCEDURE

For each test:

Assign current and voltage sources as indicated in the preset conditions table.

Execute the test as defined in the PULSAR CONDITIONS table.

Jumper relay terminals 4 to 5, 6 to 7, 8 to 9, 17 to 19, 18 to 20.

All test values are based upon a 60° maximum torque angle, 50 Reach, and the following formula:

$$Z = \frac{V}{2 \times I}$$

PULSAR TEST CONDITIONS						
ASSIGN	CONNECT		TEST	VALUES		HZ
	±	N			∠	
V _A	17	18	V _A	55	0°	60.0
I _A	3	10	I _A	5	60°	60.0
MON	1	11				

* = Value depends on offset tap

ALWAYS REFER TO THE MANUFACTURERS' LITERATURE BEFORE TESTING!

REACH TEST

1. Connect the Monitor circuit to the appropriate relay contacts.
2. Set I_A to 5A and 60°, set V_A to 55v and 0°, using the following keystrokes; **CURRENT, 1, AC, 5, PHASE, 60, VOLTAGE, 1, AC, 55, EXECUTE.**
3. Initiate PULSAR; **CURRENT, 1, ON, VOLTAGE, 1, ON, EXECUTE.** Using the appropriate Ramp Arrow keys ▲, ▼, ramp V_A until the contacts pickup.
4. Record the pickup value, refer to the GCY51 I.L. for any adjustment.
5. Turn I_A and V_A, OFF whenever an adjustment is required or the test is completed. **CURRENT, 1, VOLTAGE, 1, OFF, EXECUTE.**

MAXIMUM TORQUE ANGLE

Note: To determine maximum angle of torque, adjust the phase angle equidistance either side of the maximum angle of torque ($\pm 30^\circ$) and repeat the procedure used to determine the reach. The two points should be equal, if the maximum angle of torque is correct.

1. Set I_A to 5A and 90° , ($\pm 30^\circ$ of MTA), set V_A to 55v and 0° , using the following keystrokes; **CURRENT, 1, AC, 5, PHASE, 90, VOLTAGE, 1, AC, 55, EXECUTE.**
2. Initiate PULSAR; **CURRENT, 1, ON, VOLTAGE, 1, ON, EXECUTE.** Using the appropriate Ramp Arrow keys \blacktriangle , \blacktriangledown , ramp V_A until the contacts pickup.
3. Record the pickup value, refer to the GCY51 I.L. for any adjustment.
4. Turn I_A and V_A , OFF whenever an adjustment is required or the test is completed. **CURRENT, 1, VOLTAGE, 1, OFF, EXECUTE.**
5. Repeat the same test steps for the 30° angle ($\pm 30^\circ$ of MTA).

OFFSET

1. Set I_A to 5A and 240° , (180° opposite MTA), set V_A equal to $(*)+10\%$ above the expected pickup using the following keystrokes; **CURRENT, 1, AC, 5, PHASE, 240, VOLTAGE, 1, AC, (*), EXECUTE.**
2. Initiate PULSAR; **CURRENT, 1, VOLTAGE, 1, ON, EXECUTE.**
3. Using the appropriate Ramp Arrow keys \blacktriangle , \blacktriangledown , ramp V_A until the contacts pickup.
4. Record the pickup and refer to the GCY51 I.L. for any adjustment.
5. Turn V_A and I_A , OFF whenever an adjustment is required or the test is completed; **CURRENT, 1, VOLTAGE, 1, OFF, EXECUTE.**

Testing of General Electric Type GGP Relay

AVO
Multi-Amp

PULSAR

Date: September 30, 1993 Rev: A
IEEE Device Number: 32
Function: Power Directional Relay

This relay test sheet describes the use of the AVO Multi-Amp PULSAR test instrument to perform the GGP53C protective relay acceptance tests. Test connections to the AVO Multi-Amp PULSAR relay test set and manufacturer recommended relay settings are included.

References:

Manufacturer's Reference
Literature

GEK-34117C

Test Equipment
Instructional Material

PULSAR Operating Manual

Description of Relay

The GGP53C is a polyphase power directional relay used in protection schemes for sensitive anti-motoring protection for steam turbine generators. The relay consists of a time delay overvoltage unit (top unit) and a three-phase directional unit (bottom unit).

PRECAUTIONS

*******WARNING*******

Dangerous and potentially fatal voltage can be developed across the output terminals of the PULSAR relay test set, refer to the PULSAR operation manual for further instructions.

Always turn the outputs **OFF** before connecting, removing or touching any output terminal or test lead, use extreme caution when turning on or using the PULSAR relay test set.

ALWAYS TEST THIS RELAY IN ITS CASE.

The GGP53C is polyphase power directional relay used in protection schemes for sensitive anti-motoring protection for steam turbine generators. The relay consists of a time delay overvoltage unit (top unit) and a three-phase directional unit (bottom unit).

(*) for I_A , I_B , I_C are .01 amperes (10 milliamperes).

PULSAR TEST CONDITIONS						
Assign	Connect		Test	Values		Hz
	+	N			∅	
U_A	14		U_A	69.2	0°	60.0
U_B	13		U_B	69.2	120°	60.0
U_C	15		U_C	69.2	240°	60.0
I_A	3		I_A^*	.01	180°	60.0
I_B	5		I_B^*	.01	300°	60.0
I_C	7		I_C^*	.01	60°	60.0
MON	TB1-9	TB1-10				

ALWAYS REFER TO THE MANUFACTURERS' LITERATURE BEFORE TESTING!

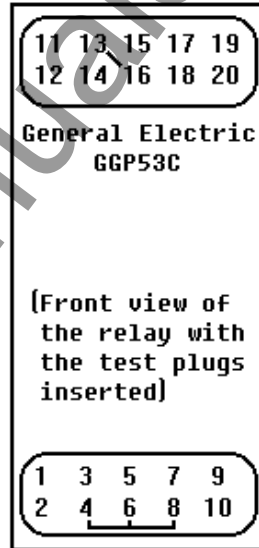

Relay Notes:

SETUP AND PROCEDURE

For Pick Up and Timing Test, assign current and voltage sources as indicated in the preset conditions table below.

PULSAR TEST CONDITIONS						
ASSIGN	CONNECT		TEST	VALUES		HZ
	±	N			∠	
V _A	12	2	V _A	*	0°	60.0
MON	1	11				

PICKUP TEST (TOP UNIT)

1. Set V_A equal to 40% of rated voltage and turn V_A on using the following keystrokes; **VOLTAGE, 1, AC, 48, ON, EXECUTE** (use 48 or 83 volts for 120 or 208 volt relays respectively).
2. Ramp V_A up using the appropriate **▲ RAMP** key until the contacts pickup.
3. Record the minimum pickup value (normally 50 % of rated voltage ± 3 %).
4. Turn V_A OFF by pressing; **OFF, EXECUTE**.

TIMING TEST (TOP UNIT)

1. Set V_A to rated voltage by using the following keystrokes; **VOLTAGE, 1, AC, 120 (or 208), EXECUTE**. NOTE: The output should not be ON yet.
2. Move monitor circuit to timer stop gate, (T2). Set output to turn off when the relay trips by using the following keystrokes; **Shift, A-OFF, ON, EXECUTE**.
3. Initiate V_A and start the Timer using the following keystrokes; **ON, TIMER START, EXECUTE**.
4. Record the timing pickup value. Repeat testing sequence for any additional time dial settings.
5. De-initiate V_A if Auto-off feature was not used by pressing, **OFF, EXECUTE**.

PICK UP OF DIRECTIONAL UNIT (BOTTOM UNIT)

1. With reference to figure 10, GEK-34117, jumper GGP terminals 4 to 6 to 8, and jumper terminal 13 to 16.
2. Assign current and voltage sources as indicated in the following preset conditions table. The test values defined with the (*) for I_A, I_B, and I_C are .01 amperes (10 milliamperes). The typical pickup value is 10

milliamperes. The pickup may be adjusted as high as 40 milliamperes. The voltage preset values are for a 120 volt phase-to-phase rated relay. To set the three voltage and current output amplitudes use the following keystrokes; **VOLTAGE, 0, AC, 69.2, CURRENT, 0, AC, .01, EXECUTE**. To set phase angles use the following keystrokes; **VOLTAGE 2, CURRENT, 2, PHASE, 120, VOLTAGE 3, CURRENT, 3, PHASE, 240, EXECUTE**. To adjust the three current channels to the proper phase angle relationship, use the following keystrokes; **CURRENT, 0, PHASE**, press and hold the appropriate **▲ RAMP** key until 180° is displayed on I_A. Note that I_B and I_C should now be at their respective phase angles as shown below.

PULSAR TEST CONDITIONS						
ASSIGN	CONNECT		TEST	VALUES		HZ
	±	N			∠	
V _A	14		V _A	69.2	0°	60.0
V _B	13		V _B	69.2	120°	60.0
V _C	15		V _C	69.2	240°	60.0
I _A	3		I _A *	.01	180°	60.0
I _B	5		I _B *	.01	300°	60.0
I _C	7		I _C *	.01	60°	60.0
MON	TB1-9	TB1-10				

3. Initiate all voltage and current channels using the following keystrokes; **VOLTAGE, 0, CURRENT, 0, ON, EXECUTE**. All output channels should be ON.
4. Ramp currents up or down to determine minimum pickup value using the following keystrokes; **CURRENT, 0, AC**, and press the least significant **▲** or **▼ RAMP** key to increment currents in milliamperes.
5. Record the minimum pickup value.
6. Reverse the phase angle to I_A, I_B, and I_C the directional contacts should have a restraining torque. To reverse the phase angle use the following keystrokes; **CURRENT, 0, PHASE**, and press the appropriate **▲ RAMP** key until 0° is displayed on I_A. I_B and I_C should now be at their respective phase angles of 120° and 240°.
7. De-initiate all voltage and current channels by using the following keystrokes; **VOLTAGE, 0, CURRENT, 0, OFF, EXECUTE**.

Testing of Westinghouse Type HU and HU-1 Relays

AVO
Multi-Amp

PULSAR

Date: September 30, 1993 Rev: B
IEEE Device Number: 87
Function: Transformer Differential

This relay test sheet describes the use of the AVO Multi-Amp PULSAR test instrument to perform the HU protective relay acceptance tests. Test connections to the AVO Multi-Amp PULSAR relay test set and manufacturer recommended relay settings are included.

References:

Manufacturer's Reference
Literature

I.L. 41-347.1Q

Test Equipment
Instructional Material

PULSAR Operating Manual

Description of Relay

The HU relay is a high-speed relay used in the differential protection of transformers. These relays can be applied where the magnetizing inrush current to the transformer is severe. The HU relay has two restraint transformers and two rows of taps. The HU relay has a differential unit a harmonic restrain unit, an indicating contactor switch unit and instantaneous trip unit.

PRECAUTIONS

*******WARNING*******

Dangerous and potentially fatal voltage can be developed across the output terminals of the PULSAR relay test set, refer to the PULSAR operation manual for further instructions.

Always turn the outputs **OFF** before connecting, removing or touching any output terminal or test lead, use extreme caution when turning on or using the PULSAR relay test set.

ALWAYS TEST THIS RELAY IN ITS CASE.

SETUP AND PROCEDURE

For each test:

Always apply a POLARIZE Current of 90 Amps before each test.

Assign current and voltage sources as indicated in the preset conditions table. The test values are based upon a 5A tap and 20% slope relay setting.

PULSAR TEST CONDITIONS						
ASSIGN	CONNECT		TEST	VALUES		HZ
	±	N			∠	
I _A	5	3	I _A	1.2	0°	60.0
I _B	7	3	I _B	1.2	0°	60.0
MON	10	1				

MINIMUM PICKUP

1. Block the Harmonic Restraint contacts closed.
2. Polarize HU relay with 90 amps across restraint windings 5 and 3. Connect I_C in parallel with I_A and I_B; **CURRENT, 0, AC, 30, ON, Shift, A-OFF, ON, EXECUTE**. After Polarization reset A-OFF; **Shift, A-OFF, OFF, EXECUTE**.
3. Set PULSAR current channels to test parameters equal to (tap * 0.3) value; **CURRENT, 1, 2, AC, 1.2, EXECUTE**.
4. Turn current (I_A) ON; **CURRENT, 1, AC, ON, EXECUTE**. Using RAMP Arrow keys, ramp current channel up or down to find minimum pickup. Turn I_A OFF; **CURRENT, 1, OFF, EXECUTE**. Repeat test for current I_B, all commands for I_B are CURRENT, 2.
5. Minimum pickup should be within ±10% of (tap * 0.3) value. Refer to relay instruction manual for adjustment to minimum pickup resistor.

PULSAR TEST CONDITIONS						
ASSIGN	CONNECT		TEST	VALUES		HZ
	±	N			∠	
I _A	5	7	I _A	25	0°	60.0
MON	10	1				

THROUGH FAULT RESTRAINT

1. Block the Harmonic Restraint contacts closed.
2. Polarize HU relay with 90 amps across restraint windings 5 and 3. Connect I_C in parallel with I_A and I_B; **CURRENT, 0, AC, 30, ON, Shift, A-OFF, ON, EXECUTE**. After Polarization reset **A-OFF; Shift, A-OFF, OFF, EXECUTE**.
3. Set PULSAR current channels to test parameters with current channel I_A equal to 25 amperes, turn current I_A ON; **CURRENT, 1, AC, 25, ON, EXECUTE**. HU relay should be in restraint, (relay's main trip contacts remain open rather than close).
4. Turn current OFF; **CURRENT, 1, OFF, EXECUTE**. Disconnect relay and set up for Harmonic restraint test.

PULSAR TEST CONDITIONS						
ASSIGN	CONNECT		TEST	VALUES		HZ
	±	N			∠	
I _A	5	3	I _A	7	0°	60.0
I _B	5	3	I _B	1	0°	120.0
MON	10	1				

HARMONIC RESTRAINT using pure 2nd Harmonic Current

1. Block the Differential Unit contacts closed.
2. Polarize HU relay with 90 amps across restraint windings 5 and 3. Connect I_C in parallel with I_A and I_B; **CURRENT, 0, AC, 30, ON, Shift, A-OFF, ON, EXECUTE**. After Polarization reset **A-OFF; Shift, A-OFF, OFF, EXECUTE**.
3. Set I_A and I_B on PULSAR to above parameters; **CURRENT, 2, AC, 1, FREQ, 120, Shift, RST_PH, ON, CURRENT, 1, AC, 7, ON, EXECUTE**.

4. Using the Ramp Arrow keys ramp I_A up or down to find pickup of harmonic restraint trip contact.
5. Record value.
6. De-initiate PULSAR if adjustment to HU relay is necessary; **CURRENT, 0, OFF, EXECUTE.**
7. Calculate percent harmonic with the formula as referred to under Current Sources-Harmonic Restraint Test.
8. When test is complete, reset frequency to 60 Hz on I_B ; **CURRENT, 2, FREQ, 60, Shift, RST_PH, EXECUTE.**

PULSAR TEST CONDITIONS						
ASSIGN	CONNECT		TEST	VALUES		HZ
	\pm	N			\angle	
I_A	5	3	I_A	7	0°	60.0
I_B	5	3	I_B	8.89	0°	60.0
MON	10	1				

HARMONIC RESTRAINT using H_WAVE (Diode Test Method)

1. Block the Differential Unit contacts closed.
2. Polarize HU relay with 90 amps across restraint windings 5 and 3. Connect I_C in parallel with I_A and I_B ; **CURRENT, 0, AC, 30, ON, Shift, A-OFF, ON, EXECUTE.** After Polarization reset A-OFF; **Shift, A-OFF, OFF, EXECUTE.**
3. Set I_A and I_B on PULSAR to above parameters with I_B to 8.89A, H_WAVE, to establish 4A I_{dc} (as required for diode test method), refer to section Current Sources-Harmonic Restraint Test.; **CURRENT, 2, AC, 8.89, Shift, H_WAVE, Shift, RST_PH, ON, CURRENT, 1, AC, 7, ON, EXECUTE.**
4. Using the Ramp Arrow keys ramp I_A up or down to find pickup of harmonic restraint trip contact.
5. Record value.
6. De-initiate PULSAR if adjustment to HU relay is necessary; **CURRENT, 0, AC, OFF, EXECUTE.**
7. Refer to the manufacturers instruction literature for the appropriate % Harmonic Curve.
8. When test is complete, restore sine wave; **CURRENT, 0, Shift, SINE, EXECUTE.**

PULSAR TEST CONDITIONS						
ASSIGN	CONNECT		TEST	VALUES		HZ
	±	N			∠	
I _A	5	3	I _A	2	0°	60.0
I _B	5	7	I _B	10	0°	60.0
MON	10	1				

SLOPE TEST

1. Block the Harmonic Restraint Unit contacts closed.
2. Polarize HU relay with 90 amps across restraint windings 5 and 3. Connect I_C in parallel with I_A and I_B; **CURRENT, 0, AC, 30, ON, Shift, A-OFF, ON, EXECUTE**. After Polarization reset A-OFF; **Shift, A-OFF, OFF, EXECUTE**.
3. Set I_A equal to 2 amperes and I_B equal to 10 amperes; **CURRENT, 2, AC, 10, ON, CURRENT, 1, AC, 2, ON, EXECUTE**.
4. Using Ramp Arrow keys ramp I_A up or down until main trip contacts pickup. Record pickup value. De-initiate PULSAR I_A and I_B OFF; **CURRENT, 1, 2, OFF, EXECUTE**.
5. Using the formula; %Slope = (I_A/I_B)*100, calculate the actual HU slope characteristics. Refer to the I.L. for tolerances.

PULSAR TEST CONDITIONS						
ASSIGN	CONNECT		TEST	VALUES		HZ
	±	N			∠	
I _A	5	3	I _A	25	0°	60.0
I _B	5	3	I _B	25	0°	60.0
MON	10	2				

INSTANTANEOUS TEST

1. Set I_A and I_B equal to $(10 * 5A \text{ tap})$; **CURRENT, 1,2, AC, 25, Shift, A-OFF, ON, EXECUTE.**
2. Turn both I_A and I_B ON; **CURRENT, 1, 2, ON, EXECUTE.** Pulse I_A and I_B up or down until main trip contacts pickup, using the incremental steps of 1A and the **OFF, EXECUTE, ON, EXECUTE** sequential commands.
3. Record pickup value.
4. De-initiate PULSAR I_A and I_B OFF; **CURRENT, 1, 2, OFF, EXECUTE.**

AVO
Multi-Amp

PULSAR

Date: September 30, 1993 Rev: B
IEEE Device Number: 87
Function: Transformer Differential

This relay test sheet describes the use of the AVO Multi-Amp PULSAR test instrument to perform the HU-1 protective relay acceptance tests. Test connections to the AVO Multi-Amp PULSAR relay test set and manufacturer recommended relay settings are included.

References:

Manufacturer's Reference
Literature

I.L. 41-347.1Q

Test Equipment
Instructional Material

PULSAR Operating Manual

Description of Relay

The HU relay is a high-speed relay used in the differential protection of transformers. These relays can be applied where the magnetizing inrush current to the transformer is severe. The HU-1 relay has three restraint transformers and three rows of taps. The HU-1 relay has a differential unit, a harmonic restrain unit, an indicating contactor switch unit and instantaneous trip unit.

PRECAUTIONS

*****WARNING*****

Dangerous and potentially fatal voltage can be developed across the output terminals of the PULSAR relay test set, refer to the PULSAR operation manual for further instructions.

Always turn the outputs **OFF** before connecting, removing or touching any output terminal or test lead, use extreme caution when turning on or using the PULSAR relay test set.

ALWAYS TEST THIS RELAY IN ITS CASE .

SETUP AND PROCEDURE

For each test:

Always apply a POLARIZE Current of 90 Amps before each test.

Assign current and voltage sources as indicated in the preset conditions table. The test values are based upon a 5A tap and 20% slope relay setting.

PULSAR TEST CONDITIONS						
ASSIGN	CONNECT		TEST	VALUES		HZ
	±	N			∠	
I _A	5	3	I _A	1.2	0°	60.0
I _B	7	3	I _B	1.2	0°	60.0
I _C	9	3	I _C	1.2	0°	60.0
MON	10	1				

MINIMUM PICKUP

- Block the Harmonic Restraint contacts closed.
- Polarize HU relay with 90 amps across restraint windings 5 and 3. Connect I_C in parallel with I_A and I_B; **CURRENT, 0, AC, 30, ON, Shift, A-OFF, ON, EXECUTE**. After Polarization reset A-OFF; **Shift, A-OFF, OFF, EXECUTE**.
- Set PULSAR current channels to test parameters equal to (tap * 0.3) value; **CURRENT, 1, 2, AC, 1.2, EXECUTE**.
- Turn current (I_A) ON; **CURRENT, 1, AC, ON, EXECUTE**. Using RAMP Arrow keys, ramp current channel up or down to find minimum pickup. Turn I_A OFF; **CURRENT, 1, OFF, EXECUTE**. Repeat test for current I_B, all commands for I_B are CURRENT, 2.
- Minimum pickup should be within ±10% of (tap * 0.3) value. Refer to relay instruction manual for adjustment to minimum pickup resistor.

PULSAR TEST CONDITIONS						
ASSIGN	CONNECT		TEST	VALUES		HZ
	±	N			∠	
I _A	5	7	I _A	25	0°	60.0
I _B	9	7	I _B	25	0°	60.0
MON	10	1				

THROUGH CURRENT RESTRAINT

1. Block the Harmonic Restraint contacts closed.
2. Polarize HU relay with 90 amps across restraint windings 5 and 3. Connect I_C in parallel with I_A and I_B; **CURRENT, 0, AC, 30, ON, Shift, A-OFF, ON, EXECUTE**. After Polarization reset A-OFF; **Shift, A-OFF, OFF, EXECUTE**.
3. Set PULSAR current channels to test parameters with current channel I_A equal to 25 amperes, turn current I_A ON; **CURRENT, 1, AC, 25, ON, EXECUTE**. HU relay should be in restraint, (relay's main trip contacts remain open rather than close).
4. Turn current OFF; **CURRENT, 1, OFF, EXECUTE**. Disconnect relay and set up for Harmonic restraint test.

PULSAR TEST CONDITIONS						
ASSIGN	CONNECT		TEST	VALUES		HZ
	±	N			∠	
I _A	5	3	I _A	7	0°	60.0
I _B	5	3	I _B	1	0°	120.0
MON	10	1				

HARMONIC RESTRAINT using pure 2nd Harmonic Current

1. Block the Differential Unit contacts closed.
2. Polarize HU relay with 90 amps across restraint windings 5 and 3. Connect I_C in parallel with I_A and I_B; **CURRENT, 0, AC, 30, ON, Shift, A-OFF, ON, EXECUTE**. After Polarization reset A-OFF; **Shift, A-OFF, OFF, EXECUTE**.
3. Set I_A and I_B on PULSAR to above parameters; **CURRENT, 2, AC, 1, FREQ, 120, Shift, RST_PH, ON, CURRENT, 1, AC, 7, ON, EXECUTE**.

4. Using the Ramp Arrow keys ramp I_A up or down to find pickup of harmonic restraint trip contact.
5. Record value.
6. De-initiate PULSAR if adjustment to HU relay is necessary; **CURRENT, 0, OFF, EXECUTE.**
7. Calculate percent harmonic with the formula as referred to under Current Sources-Harmonic Restraint Test.
8. When test is complete, reset frequency to 60 Hz on I_B ; **CURRENT, 2, FREQ, 60, Shift, RST_PH, EXECUTE.**

PULSAR TEST CONDITIONS						
ASSIGN	CONNECT		TEST	VALUES		HZ
	±	N			∠	
I_A	5	3	I_A	7	0°	60.0
I_B	5	3	I_B	8.89	0°	----
MON	10	1				

HARMONIC RESTRAINT using H_WAVE (Diode Test Method)

1. Block the Differential Unit contacts closed.
2. Polarize HU relay with 90 amps across restraint windings 5 and 3. Connect I_C in parallel with I_A and I_B ; **CURRENT, 0, AC, 30, ON, Shift, A-OFF, ON, EXECUTE.** After Polarization reset A-OFF; **Shift, A-OFF, OFF, EXECUTE.**
3. Set I_A and I_B on PULSAR to above parameters with I_B to 8.89A, H_WAVE, to establish 4A I_{dc} (as required for diode test method), refer to section Current Sources-Harmonic Restraint Test.; **CURRENT, 2, AC, 8.89, Shift, H_WAVE, Shift, RST_PH, ON, CURRENT, 1, AC, 7, ON, EXECUTE.**
4. Using the Ramp Arrow keys ramp I_A up or down to find pickup of harmonic restraint trip contact.
5. Record value.
6. De-initiate PULSAR if adjustment to HU relay is necessary; **CURRENT, 0, OFF, EXECUTE.**
7. Refer to the manufacturers instruction literature for the appropriate % Harmonic Curve.
8. When test is complete, restore sine wave; **CURRENT, 0, Shift, SINE, EXECUTE.**

PULSAR TEST CONDITIONS						
ASSIGN	CONNECT		TEST	VALUES		HZ
	±	N			∠	
I _A	5	3	I _A	2	0°	60.0
I _B	5	7	I _B	10	0°	60.0
I _C	9	3	I _C			
MON	10	1				

SLOPE TEST

1. Block the Harmonic Restraint Unit contacts closed.
2. Polarize HU relay with 90 amps across restraint windings 5 and 3. Connect I_C in parallel with I_A and I_B; **CURRENT, 0, AC, 30, ON, Shift, A-OFF, ON, EXECUTE**. After Polarization reset A-OFF; **Shift, A-OFF, OFF, EXECUTE**.
3. Set I_A equal to 2 amperes and I_B equal to 10 amperes; **CURRENT, 2, AC, 10, ON, CURRENT, 1, AC, 2, ON, EXECUTE**.
4. Using Ramp Arrow keys ramp I_A up or down until main trip contacts pickup. Record pickup value. De-initiate PULSAR I_A and I_B OFF; **CURRENT, 1, 2, OFF, EXECUTE**.
5. Using the formula; %Slope = (I_A/I_B)*100, calculate the actual HU slope characteristics. Refer to the I.L. for tolerances.

PULSAR TEST CONDITIONS						
ASSIGN	CONNECT		TEST	VALUES		HZ
	±	N			∠	
I _A	5	3	I _A	25	0°	60.0
I _B	5	3	I _B	25	0°	60.0
I _C			I _C			
MON	10	1				

INSTANTANEOUS TEST

1. Set I_A and I_B equal to (10 * 5A tap); **CURRENT, 1,2, AC, 25, Shift, A-OFF, ON, EXECUTE**.
2. Turn both I_A and I_B ON; **CURRENT, 1, 2, ON, EXECUTE**. Pulse I_A and I_B up or down until main trip contacts pickup, using the incremental steps of 1A and the **OFF, EXECUTE, ON, EXECUTE** sequential commands.

3. Record pickup value.
4. De-initiate PULSAR I_A and I_B OFF; **CURRENT, 1, 2, OFF, EXECUTE.**

www.ElectricalPartManuals.com

Testing General Electric Type IAC Relays

AVO
Multi-Amp

PULSAR

Date: September 30, 1993 Rev: B
IEEE Device Number: 51
Function: Overcurrent

This relay test sheet describes the use of the AVO Multi-Amp PULSAR test instrument to perform the IAC protective relay acceptance tests. Test connections to the AVO Multi-Amp PULSAR relay test set and manufacturer recommended relay settings are included.

References:

Manufacturer's Reference
Literature

GEK-34053D

Test Equipment
Instructional Material

PULSAR Operating Manual

Description of Relay

The IAC are single-phase, current operated, ac devices with inverse time current characteristics. The IAC are utilized to protect commercial, industrial, and utility power distribution systems against either multi-phase or phase to ground faults.

PRECAUTIONS

*******WARNING*******

Dangerous and potentially fatal voltage can be developed across the output terminals of the PULSAR relay test set, refer to the PULSAR operation manual for further instructions.

Always turn the outputs **OFF** before connecting, removing or touching any output terminal or test lead, use extreme caution when turning on or using the PULSAR relay test set.

ALWAYS TEST THIS RELAY IN ITS CASE.

The type IAC relays comprise of a group of relays that are employed to protect against overcurrent on single phase and polyphase circuits. These relays consist of an induction unit or an induction unit with an instantaneous unit.

Test Connections:

Currents: 5 and 6.

Contacts: Toc, 1 and 2

Ioc, 1 and 3

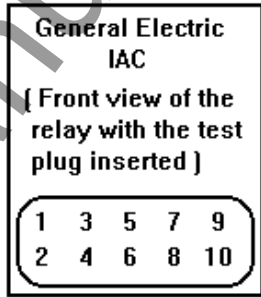

PULSAR

CONTROL MODULE	TIMER	VOLTS	VOLTS	VOLTS
		0 0↗	0 0↗	0 0↗
AMPS		AMPS		AMPS
0 0↗		0 0↗		0 0↗

ALWAYS REFER TO MANUFACTURERS' LITERATURE BEFORE TESTING!

Relay Notes:

SETUP AND PROCEDURE

For each test:

The IAC relay test is generic, the test parameters are 2A tap and 20A instantaneous unit. Your tap values may be different. Some relays may require that current channels be paralleled to increase VA or total current, i.e., 40A instantaneous will require two current channels 20 amperes each (see Operating Procedures, Section 1.1, Current Sources - Parallel Operation). If more current or Volt-Amperes are needed, see Description of Controls, paragraph 1.6, High Current Interface Module and EPOCH-20/II Specifications. Assign current and voltage sources as indicated in the preset conditions table.

PULSAR TEST CONDITIONS						
ASSIGN	CONNECT		TEST	VALUES		HZ
	±	N			∠	
I _A	5	6	I _A	2	0°	60.0
MON	1	2				

MINIMUM PICKUP TEST

1. Set I_A equal to tap value; **CURRENT, 1, AC, 2, ON, EXECUTE**. Note that the disk should be starting to move (creep).
2. Using the Ramp Arrow keys ramp I_A up and down to determine minimum pickup value.
3. Record the minimum pickup value.
4. De-initiate I_A; **CURRENT, 1, OFF, EXECUTE**.

TIMING TEST

1. Move monitor circuit to timer stop gate.
2. Set I_A equal to fault current level(s) i.e., 2x tap, and set output to turn off when relay trips using; **CURRENT, 1, AC, 4, ON, Shift, A-OFF, ON, TIMER START, EXECUTE**.
3. Upon contact closure of IAC contacts, record the timing value.

4. Repeat tests as necessary for example;
CURRENT, 1, AC, 6, ON, TIMER START, EXECUTE.
CURRENT, 1, AC, 8, ON, TIMER START, EXECUTE.
CURRENT, 1, AC, 10, ON, TIMER START, EXECUTE.
NOTE: Allow disk to completely reset after each timing test.

INSTANTANEOUS TEST

1. Move monitor circuit to terminals 1 and 3.
2. Set I_A equal to 20A ; **CURRENT, 1, AC, 20, Shift, A-OFF, ON, EXECUTE.**
3. Turn I_A ON; **CURRENT, 1, ON, EXECUTE.** Pulse I_A up or down until main trip contacts pickup, using the incremental steps of 1A and the **OFF, EXECUTE, ON, EXECUTE** sequential commands. When relay trips, output will automatically turn off.
4. Record pickup value.

Testing General Electric IAV Relay

AVO
Multi-Amp

PULSAR

Date: September 30, 1993 Rev: B
IEEE Device Number: 59
Function: Overvoltage Relay

This relay test sheet describes the use of the AVO Multi-Amp PULSAR test instrument to perform the IAV protective relay acceptance tests. Test connections to the AVO Multi-Amp PULSAR relay test set and manufacturer recommended relay settings are included.

References:

Manufacturer's Reference
Literature

GEH-1814C

Test Equipment
Instructional Material

PULSAR Operating Manual

Description of Relay

The IAV is a single phase overvoltage relay used in protection schemes for sensitive overvoltage ground detection for high impedance grounded generators or for ungrounded power systems.

NOTE: Some IAV relays are designed to operate at frequencies and voltages other than those described here. For example, 25 Hz relays and 460 volt relays. For testing 25 Hz relays, the operator will need to select a new output frequency, see Operating Procedures, Testing Frequency Relays. For output voltages in excess of 300 volts see, Voltage Sources - Outputs Summed Together.

PRECAUTIONS

*******WARNING*******

Dangerous and potentially fatal voltage can be developed across the output terminals of the PULSAR relay test set, refer to the PULSAR operation manual for further instructions.

Always turn the outputs **OFF** before connecting, removing or touching any output terminal or test lead, use extreme caution when turning on or using the PULSAR relay test set.

ALWAYS TEST THIS RELAY IN ITS CASE.

The IAU is a single phase overvoltage relay used in protection schemes for sensitive overvoltage ground detection for high impedance grounded generators or for ungrounded power systems.

Test Connections:

Potential: 5 and 6, polarity on 5.
Contact: 1 and 2.

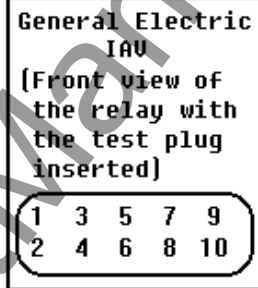

PULSAR

CONTROL MODULE	TIMER	VOLTS	VOLTS	VOLTS
		0 0↗	0 0↗	0 0↗
AMPS		AMPS		AMPS
0 0↗		0 0↗		0 0↗

ALWAYS REFER TO THE MANUFACTURERS' LITERATURE BEFORE TESTING!

Relay Notes:

SETUP AND PROCEDURE

For each test:

Assign voltage sources as indicated in the preset conditions table.

PULSAR TEST CONDITIONS						
ASSIGN	CONNECT		TEST	VALUES		HZ
	±	N			∠	
V _A	5	6	V _A	55	0°	60.0
MON	1	2				

MINIMUM PICKUP TEST

1. Set V_A equal to test parameters and initiate i.e., 55 volts; **VOLTAGE, 1, AC, 55, ON, EXECUTE.**
2. Using Ramp Arrow keys ramp V_A up or down until main trip contacts pickup.
3. Record the minimum pickup value.
4. De-initiate V_A; **VOLTAGE, 1, OFF, EXECUTE.**

TIMING TEST

1. Set V_A to normal voltage; **VOLTAGE, 1, AC, 55, ON, EXECUTE.**
2. Move monitor circuit to timer stop gate.
3. Set V_A equal to fault voltage at 110%, output turn off and Timer Stop when relay trips; **VOLTAGE, 1, AC, 60.5, ON, Shift, A-OFF, ON, TIMER START, EXECUTE.**
4. Record the timing value. Repeat testing sequence for any additional fault values.

Testing General Electric Type IJF Relay

AVO
Multi-Amp

PULSAR

Date: September 30, 1993 Rev: B
IEEE Device Number: 81
Function: Frequency Relay

This relay test sheet describes the use of the AVO Multi-Amp PULSAR test instrument to perform the IJF protective relay acceptance tests. Test connections to the AVO Multi-Amp PULSAR relay test set and manufacturer recommended relay settings are included.

References:

Manufacturer's Reference
Literature

GEI-19008E

Test Equipment
Instructional Material

PULSAR Operating Manual

Description of Relay

The IJF is a single phase induction disk relay used in protection schemes against the effects of overfrequency or underfrequency.

PRECAUTIONS

*******WARNING*******

Dangerous and potentially fatal voltage can be developed across the output terminals of the PULSAR relay test set, refer to the PULSAR operation manual for further instructions.

Always turn the outputs **OFF** before connecting, removing or touching any output terminal or test lead, use extreme caution when turning on or using the PULSAR relay test set.

ALWAYS TEST THIS RELAY IN ITS CASE.

SETUP AND PROCEDURE

For each test:

The IJF relay used is an IJF52A relay with both overfrequency and underfrequency characteristics. For this example procedure, the underfrequency setting is 58 Hz and the overfrequency setting is 62 Hz.

Assign voltage sources as indicated in the preset conditions table.

Underfrequency Test

PULSAR TEST CONDITIONS						
ASSIGN	CONNECT		TEST	VALUES		HZ
	±	N			∠	
V _A	5	6	V _A	115	0°	60.0
MON	1	2				

MINIMUM PICKUP TEST

1. Set V_A equal to test parameters and initiate; **VOLTAGE, 1, AC, 115, ON, Shift, SZ, FREQ, EXECUTE.**
2. Using Ramp Arrow keys ramp V_A frequency down until main trip contacts pickup.
3. Record the minimum pickup value.
4. De-initiate V_A; **VOLTAGE, 1, OFF, EXECUTE.**

TIMING TEST

1. Set V_A to normal voltage and frequency (if you have just completed the Pickup Test, press ON, EXECUTE go to step 2); **VOLTAGE, 1, AC, 115, FREQ, 60, ON, Shift, SZ, EXECUTE.**
2. Move monitor circuit to timer stop gate.
3. Set V_A equal to fault voltage and fault frequency 58 Hz and turn output off when relay trips; **VOLTAGE, 1, AC, 110, FREQ, 58, ON, Shift, A-OFF, ON, TIMER START, EXECUTE.**
4. Record the timing value. Repeat testing sequence for any additional fault values.
5. If you need to test Overfrequency go to next test. If all tests have been completed on the relay, reset the PULSAR to original default settings by pressing the RESET button on the Input Power Control Module.

Overfrequency Test

PULSAR TEST CONDITIONS						
ASSIGN	CONNECT		TEST	VALUES		HZ
	±	N			∠	
V _A	7	8	V _A	115	0°	60.0
MON	1	2				

MINIMUM PICKUP TEST

1. Set V_A equal to test parameters and initiate; **VOLTAGE, 1, AC, 115, ON, FREQ, Shift, SZ, EXECUTE.**
2. Using Ramp Arrow keys ramp V_A frequency up until main trip contacts pickup.
3. Record the minimum pickup value.
4. De-initiate V_A; **VOLTAGE, 1, OFF, EXECUTE.**

TIMING TEST

1. Set V_A to normal voltage and frequency (if you have just completed pickup test, press ON, EXECUTE go to step 2); **VOLTAGE, 1, AC, 115, FREQ, ON, Shift, SZ, EXECUTE.**
2. Move monitor circuit to timer stop gate.
3. Set V_A equal to fault voltage and fault frequency 62 Hz and turn output off when relay trips; **VOLTAGE, 1, AC, 110, FREQ, 62, Shift, A-OFF, ON, TIMER START, EXECUTE.**
4. Record the timing pickup value. Repeat testing sequence for any additional fault values.
5. If all tests have been completed on the relay, reset the PULSAR to original default setting by pressing the RESET button on the Input Power Control Module.

Testing General Electric Type IJS Relay

AVO
Multi-Amp

PULSAR

Date: September 30, 1993 Rev: B
IEEE Device Number: 25
Function: Synchronizing

This relay test sheet describes the use of the AVO Multi-Amp PULSAR test instrument to perform the IJS protective relay acceptance tests. Test connections to the AVO Multi-Amp PULSAR relay test set and manufacturer recommended relay settings are included.

References:

Manufacturer's Reference
Literature

GEH-1791

Test Equipment
Instructional Material

PULSAR Operating Manual

Description of Relay

The IJS is a synchro-verifier relay with line and bus voltage sensing. The synchro-verifier is used to verify the condition of synchronism existing between two system voltages. The relay's contacts will close when these voltages are within the relay's set limits.

PRECAUTIONS

*******WARNING*******

Dangerous and potentially fatal voltage can be developed across the output terminals of the PULSAR relay test set, refer to the PULSAR operation manual for further instructions.

Always turn the outputs **OFF** before connecting, removing or touching any output terminal or test lead, use extreme caution when turning on or using the PULSAR relay test set.

ALWAYS TEST THIS RELAY IN ITS CASE.

The IJS51D is a synchronism-check relay used to permit closure of a circuit breaker, provided the two sources connected to it are correctly synchronized elsewhere. This relay will require two potentials with phase shifting capability.

Test Connections:

Potentials: 5 and 6, polarity on 5. 7 and 8 polarity on 7.
contacts: 1 to 2.

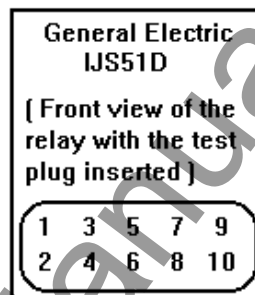

PULSAR

CONTROL MODULE	TIMER	VOLTS	VOLTS	VOLTS
		0 0↗	0 0↗	0 0↗
AMPS		AMPS		AMPS
0 0↗		0 0↗		0 0↗

ALWAYS REFER TO THE MANUFACTURERS' LITERATURE BEFORE TESTING!

Relay Notes:

SETUP AND PROCEDURE

For each test:

Assign voltage sources as indicated in the preset conditions table. The test values are based upon a 20° closing angle relay setting.

PULSAR TEST CONDITIONS						
ASSIGN	CONNECT		TEST	VALUES		HZ
	±	N			∠	
V _A	5	6	V _A	120	0°	60.0
V _B	7	8	V _B	120	0°	60.0
MON	1	2				

CENTERING CIRCLE (IJS)

1. Set PULSAR voltage channel V_A and V_B to rated voltage at 0°, turn V_A and V_B ON; **VOLTAGE, 1, 2, AC, 120, ON, EXECUTE.**
2. Using the Ramp Arrow keys ramp the phase angle for V_B in the lagging direction, (0° to 20°); **VOLTAGE, 2, PHASE, RAMP ▲** until the contacts open, record this value. Ramp the phase angle in the, opposite, leading direction, (0° to 340°), until the contacts open a second time, record this value.
3. If the two angles are not within ±1° of each other, adjustment must be made to center the IJS. Refer to instruction manual for proper adjustment to the resistor.
4. De-initiate PULSAR; **VOLTAGE, 1, 2, OFF, EXECUTE** whenever adjustment is required to the relay or the test is completed.

TIMING TEST

1. Move monitor circuit to timer stop gate on PULSAR.
2. Set PULSAR voltage channels V_A and V_B to rated voltage at 0° and outputs to turn off when relay trips; **VOLTAGE, 1, 2, AC, 120, PHASE, 0, ON, Shift, A-OFF, ON, TIMER START, EXECUTE.**
3. Record timing value.
4. Repeat test as necessary.

5. De-initiate PULSAR if the outputs are not off; **VOLTAGE, 1, 2, OFF, EXECUTE** whenever adjustment is required to the relay or the test is completed.

www.ElectricalPartManuals.com

Testing Westinghouse Type IRD and IRV Relays

AVO
Multi-Amp

PULSAR

Date: September 30, 1993 Rev: B
IEEE Device Number: 67
Function: Directional Overcurrent

This relay test sheet describes the use of the AVO Multi-Amp PULSAR test instrument to perform the IRD and IRV protective relays acceptance tests. Test connections to the AVO Multi-Amp PULSAR relay test set and manufacturer recommended relay settings are included.

References:

Manufacturer's Reference
Literature

I.L. 41-133P

Test Equipment
Instructional Material

PULSAR Operating Manual

Description of Relay

The IRD is a dual polarized relay for directional ground overcurrent faults. The IRV is a directional overcurrent relay for phase protection.

PRECAUTIONS

*******WARNING*******

Dangerous and potentially fatal voltage can be developed across the output terminals of the PULSAR relay test set, refer to the PULSAR operation manual for further instructions.

Always turn the outputs **OFF** before connecting, removing or touching any output terminal or test lead, use extreme caution when turning on or using the PULSAR relay test set.

ALWAYS TEST THIS RELAY IN ITS CASE.

These are directional overcurrent relays types IRD,IRC,and IRP. This relay will require a single potential and current.

Test Connections:

Potentials: 4 and 5, polarity on 5.
 Currents: Jumper 6-8, polarity on 9 and common on 7.
 contacts: 1 to 10.

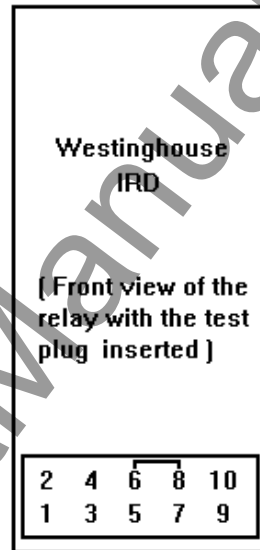

PULSAR

CONTROL MODULE	TIMER	VOLTS	VOLTS	VOLTS
		0 0↗	0 0↗	0 0↗
AMPS		AMPS		AMPS
0 0↗		0 0↗		0 0↗

ALWAYS REFER TO THE MANUFACTURERS' LITERATURE BEFORE TESTING!

Relay Notes:

SETUP AND PROCEDURE

For each test:

The IRD relay test is generic, the test parameters are 2A tap and 20A instantaneous unit. Your tap values may be different. Some relays may require that current channels be paralleled to increase VA or total current, (see Operating Procedures, Section 1.1, Current Sources - Parallel Operation). If more current or Volt-Amperes are needed, see Description of Controls, paragraph 1.6, High Current Interface Module and EPOCH-20/II Specifications.

Jumper relay terminals 6 to 8.

Connect CS-1 unit's relay terminals 10 (+) and 3 (-) to the 125 volt dc Battery Simulator for relay simulation testing of directional overcurrent relays.

PULSAR TEST CONDITIONS						
ASSIGN	CONNECT		TEST	VALUES		HZ
	±	N			∠	
V _A	4	5	V _A	*	0°	60.0
I _A	9	7	I _A	2	0°	60.0
MON	10	1				

MINIMUM PICKUP TEST

1. Set I_A equal to 1.5 times tap value and initiate; **CURRENT, 1, AC, 3, ON, EXECUTE.**
2. Using Ramp Arrow keys ramp current up or down to determine minimum pickup value.
3. Record the minimum pickup value.
4. De-initiate I_A; **OFF, EXECUTE.**

TIMING TEST

1. Move monitor circuit to timer stop gate.
2. Set I_A equal to fault current level(s); **CURRENT, 1, AC, 4, ON, Shift, A-OFF, ON, EXECUTE.**
3. Upon contact closure, record the minimum pickup value.

4. Repeat tests as necessary.
5. Reset A-OFF function; **Shift, A-OFF, OFF, EXECUTE.**

DIRECTIONAL UNIT TEST

1. Set V_A and I_A equal to directional unit sensitivity, per I.L., Table 1 page 28. For example, an IRD with .5 to 2.5 Amp tap, the directional unit contacts should close with 1 volt and 4 amperes, in phase, applied to their respective terminals. To set in phase, 1 volt and 4 amperes: **VOLTAGE, 1, AC, 1, CURRENT, 1, AC, 4, EXECUTE.** If it is desired to test at 60° lagging then; **VOLTAGE, 1, AC, 1, CURRENT, 1, AC, 2, PHASE, 60, EXECUTE.**
2. Initiate V_A and I_A ; **VOLTAGE, 1, ON, CURRENT, 1, AC, ON, EXECUTE.**
3. Ramp current up or down to determine minimum pickup value by pressing the RAMP up or down arrow keys.
4. Record the minimum pickup value.
5. De-initiate V_A and I_A ; **VOLTAGE, 1, CURRENT, 1, OFF, EXECUTE.**

INSTANTANEOUS OVERCURRENT PICKUP TEST

NOTE: Due to possible high impedance, it may be required to parallel two or more current channels for higher V_A . See Operating procedures, Section 1.1, Current Sources - Parallel Operation. Or, use and EPOCH-20/II with High Current Interface Module, see Descriptions of Controls, paragraph 1.6 and EPOCH-20/II Specifications.

1. Connect monitor circuit to relay terminals 10 and 2.
2. Block normally open directional unit contacts closed.
3. Connect relay terminals 9(±) and 4(N) to I_A . Set I_A equal to instantaneous fault current level(s) i.e., 20 amperes and turn off output when relay triggers; **CURRENT, 1, AC, 20, Shift, A-OFF, ON, EXECUTE.**
4. Turn I_A ON; **CURRENT, 1, ON, EXECUTE.** Pulse I_A up or down until main trip contacts pickup, using the incremental steps of 1A and the **OFF, EXECUTE, ON, EXECUTE** sequential commands. Initiate I_A , upon contact closure of contacts, record the pickup value.
5. Repeat test as necessary using on and off commands.
6. Reset A-OFF command; **Shift, A-OFF, OFF, EXECUTE.**

Testing General Electric Type JBC and JBCV Relays

AVO
Multi-Amp

PULSAR

Date: September 30, 1993 Rev: B
IEEE Device Number: 67
Function: Directional Overcurrent

This relay test sheet describes the use of the AVO Multi-Amp PULSAR test instrument to perform the JBC and JBCV protective relays acceptance tests. Test connections to the AVO Multi-Amp PULSAR relay test set and manufacturer recommended relay settings are included.

References:

Manufacturer's Reference
Literature

GEK-49848 & GEK-49850

Test Equipment
Instructional Material

PULSAR Operating Manual

Description of Relay

The JBC is a phase directional overcurrent relay. The JBCV is a phase directional overcurrent relay with voltage restraint. Both relays are for phase protection.

PRECAUTIONS

*******WARNING*******

Dangerous and potentially fatal voltage can be developed across the output terminals of the PULSAR relay test set, refer to the PULSAR operation manual for further instructions.

Always turn the outputs **OFF** before connecting, removing or touching any output terminal or test lead, use extreme caution when turning on or using the PULSAR relay test set.

ALWAYS TEST THIS RELAY IN ITS CASE.

SETUP AND PROCEDURE

For each test:

For this example procedure, the JBC relay test parameters are 2A tap and 20A instantaneous unit.

NOTE: Some relays may require that current channels be paralleled to increase VA or total current, see Operating Procedures, Section 1.1, Current-Sources - Parallel Operation. If more current or Volt-Amperes are needed, see Description of Controls, paragraph 1.6, High Current Interface Module and EPOCH-20/II Specifications.

Assign current and voltage sources as indicated in the preset conditions table.

PULSAR TEST CONDITIONS						
ASSIGN	CONNECT		TEST	VALUES		HZ
	±	N			∠	
I _A	3	4	I _A	2	0°	60.0
MON	1	11				

MINIMUM PICKUP TEST

1. Set I_A equal to tap value and initiate; **CURRENT, 1, AC, 2, ON, EXECUTE**. Note that overcurrent disk is slowly moving (creep).
2. Using Ramp Arrow keys ramp current up or down to determine minimum pickup value.
3. Record the minimum pickup value.
4. De-initiate I_A; **CURRENT, 1, OFF, EXECUTE**.

TIMING TEST

1. Move monitor circuit to timer stop gate.
2. Set I_A equal to fault current level(s) i.e., 2x tap, and turn outputs off when the relay trips; **CURRENT, 1, AC, 4, ON, Shift, A-OFF, ON, TIMER START, EXECUTE**.
3. Upon contact closure, record the timing value.

4. Repeat tests as necessary.
5. Reset A-OFF function; **Shift, A-OFF, OFF, EXECUTE.**

PULSAR TEST CONDITIONS						
ASSIGN	CONNECT		TEST	VALUES		HZ
	±	N			∠	
V _A	7	8	V _A	115	*	60.0
I _A	5	6	I _A	2	0°	60.0
MON	1	11				

DIRECTIONAL UNIT TEST

1. Set V_A and I_A for directional unit polarity check based on Figure 24 of instruction manual and table parameters below. Refer to Phase Angle Relationships Section. All current angles in JBC instruction manual are leading angles, those listed below are lagging angles.
2. Ramp current up or down to determine minimum pickup value.
3. Record the minimum pickup value.

P.F. Angle - Lag	90-135	135-180	180-225	225-270	270-315	315-360	0-45	45-90
Power Flow KW IN/OUT	OUT	IN	IN	IN	IN	OUT	OUT	OUT

4. Contacts should be closed when KW flow is IN and open when KW flow is out.
5. De-initiate V_A and I_A; **VOLTAGE, 1, CURRENT, 1, OFF, EXECUTE.**

INSTANTANEOUS OVERCURRENT PICKUP TEST

1. Connect monitor circuit to relay terminals 1 and 12.
2. Block normally open directional unit contacts closed.
3. Connect relay terminals 2(±) and 3(N) to I_A. Set I_A equal to instantaneous fault current level(s) i. e., 20 amperes and turn outputs off when relay trips; **CURRENT, 1, AC, 20, Shift, A-OFF, ON, EXECUTE.**
4. Turn I_A ON; **CURRENT, 1, ON, EXECUTE.** Pulse I_A up or down until main trip contacts pickup, using the incremental steps of 1A and the **OFF, EXECUTE, ON, EXECUTE** sequential commands. Record the pickup value.

5. Repeat test as necessary using on and off commands.
6. Reset A-OFF command; **Shift, A-OFF, OFF, EXECUTE.**

www.ElectricalPartManuals.com

Testing General Electric Type JBCG51 Relay

AVO
Multi-Amp

PULSAR

Date: September 30, 1993 Rev: B
IEEE Device Number: 67
Function: Directional Overcurrent

This relay test sheet describes the use of the AVO Multi-Amp PULSAR test instrument to perform the JBCG51E protective relays acceptance tests. Test connections to the AVO Multi-Amp PULSAR relay test set and manufacturer recommended relay settings are included.

References:

Manufacturer's Reference
Literature

GEK-49849A

Test Equipment
Instructional Material

PULSAR Operating Manual

Description of Relay

The JBCG51E is a ground directional overcurrent relay used primarily for the protection of feeders and transmission lines. They are available with inverse, very inverse, or extremely inverse time characteristics.

PRECAUTIONS

*******WARNING*******

Dangerous and potentially fatal voltage can be developed across the output terminals of the PULSAR relay test set, refer to the PULSAR operation manual for further instructions.

Always turn the outputs **OFF** before connecting, removing or touching any output terminal or test lead, use extreme caution when turning on or using the PULSAR relay test set.

ALWAYS TEST THIS RELAY IN ITS CASE.

SETUP AND PROCEDURE

For each test:

The JBCG relay example test parameters are 2A tap and 20A instantaneous unit.

Assign current and voltage sources as indicated in the preset conditions table.

PULSAR TEST CONDITIONS						
ASSIGN	CONNECT		TEST	VALUES		HZ
	±	N			∠	
I _A	2	4	I _A	2	0°	60.0
MON	1	11				

NOTE: Block directional contacts closed for Overcurrent pickup and timing tests.

MINIMUM PICKUP TEST

1. Set I_A equal to tap value and initiate; **CURRENT, 1, AC, 2, ON, EXECUTE**. Note that overcurrent disk is slowly moving (creep).
2. Using Ramp Arrow keys ramp current up or down to determine minimum pickup value.
3. Record the minimum pickup value.
4. De-initiate I_A; **CURRENT, 1, OFF, EXECUTE**.

OVERCURRENT TIMING TEST

1. Move monitor circuit to timer stop gate.
2. Set I_A equal to fault current level(s) i. e., 2x tap, and turn output off when relay trips; **CURRENT, 1, AC, 4, ON, Shift, A-OFF, ON, TIMER START, EXECUTE**.
3. Upon contact closure, record the timing value.
4. Repeat tests as necessary; **ON, TIMER START, EXECUTE**.
5. Reset A-OFF function; **Shift, A-OFF, OFF, EXECUTE**.

NOTE: Remove blocking material from directional unit.

DIRECTIONAL UNIT CURRENT POLARIZATION TEST

1. Jumper relay terminals 6 to 7 and 9 to 10. Move MONITOR lead from 11 to 19.
2. Connect relay terminals 5(±) and 8(N) to I_A . Polarization angle is 0° .
3. Set I_A equal to .25 Amperes and initiate; **CURRENT, 1, AC, .25, ON, EXECUTE.**
4. Using Ramp Arrow keys, ramp current up to determine minimum pickup value.
5. Record minimum pickup value, de-initiate I_A ; **OFF, EXECUTE.**
6. Remove jumpers.

DIRECTIONAL UNIT POTENTIAL POLARIZATION TEST

1. Connect relay terminals 9(±) and 10(N) to V_A and relay terminals 5(±) and 6(N) to I_A . Monitor terminals 1 and 19.
2. Set V_A to 5 volts and I_A .5 amperes; **VOLTAGE, 1, AC, 5, ON, CURRENT, 1, AC, .5, ON, EXECUTE.**
3. Using Ramp Arrow keys, ramp current up to determine minimum pickup.
4. Record minimum pickup, de-initiate V_A and I_A ; **VOLTAGE, 1, CURRENT, 1, OFF, EXECUTE.**

INSTANTANEOUS OVERCURRENT PICKUP TEST

1. Connect monitor circuit to relay terminals 1 and 12.
2. Block normally open directional unit contacts closed.
3. Connect relay terminals 2(±) and 3(N) to I_A . Set I_A equal to instantaneous fault current level(s); **CURRENT, 1, AC, 20, Shift, A-OFF, ON, EXECUTE.**
4. Turn I_A ON; **CURRENT, 1, ON, EXECUTE.** Pulse I_A up or down until main trip contacts pickup, using the incremental steps of 1A and the **OFF, EXECUTE, ON, EXECUTE** sequential commands. Initiate I_A , upon contact closure of contacts, record the pickup value.
5. Repeat test as necessary using on and off commands.
6. Reset A-OFF command; **Shift, A-OFF, OFF, EXECUTE.**

Testing Westinghouse Type KA Relay

AVO
Multi-Amp

PULSAR

Date: September 30, 1992 Rev: A
IEEE Device Number: 85
Function: Carrier Auxiliary

This relay test sheet describes the use of the AVO Multi-Amp PULSAR test instrument to perform the KA-4 protective relay acceptance tests. Test connections to the AVO Multi-Amp PULSAR relay test set and manufacturer recommended relay settings are included.

References:

Manufacturer's Reference
Literature

I.L. 41-923.4M

Test Equipment
Instructional Material

PULSAR Operating Manual

Description of Relay

The KA-4 relay is an auxiliary relay used in the type KD directional comparison tripping system. The KA-4 provides a circuit for high-speed tripping, controls the transfer tripping signal for remote line terminals and supplies necessary coordination during power reversal conditions.

PRECAUTIONS

*******WARNING*******

Dangerous and potentially fatal voltage can be developed across the output terminals of the PULSAR relay test set, refer to the PULSAR operation manual for further instructions.

Always turn the outputs **OFF** before connecting, removing or touching any output terminal or test lead, use extreme caution when turning on or using the PULSAR relay test set.

ALWAYS TEST THIS RELAY IN ITS CASE.

SETUP AND PROCEDURE

For each test:

Assign current and voltage sources as indicated in the preset conditions table.

PULSAR TEST CONDITIONS						
ASSIGN	CONNECT		TEST	VALUES		HZ
	±	N			∠	
V _A	*	*	V _A	*	dc	dc
I _A	*	*	I _A	*	0°	60.0
MON	*	*				

OVERCURRENT MINIMUM PICKUP TEST

1. Connect relay terminals 17(±) and 16(N) to I_A.
2. Set I_A at 0.2 amps; **CURRENT, 1, AC, 0.2, ON, EXECUTE**. Using the Ramp Arrow keys ramp current up until normally closed contacts 'just open' to determine minimum pickup value
3. Record the minimum carrier start value.
4. De-initiate I_A; **OFF, EXECUTE**.

CSP UNIT PICKUP TEST

1. Connect relay terminals 2(±) and 1(N) to V_A, with V_A set to dc voltage. Monitor circuit should be connected directly across CSP normally open contacts; **VOLTAGE, 1, DC, 125, ON, EXECUTE**.
2. Refer to KA-4 relay settings on CSP and ramp dc voltage until CSP contacts close. This dc voltage value should be within (±5%) of rated dc voltage.
3. Record the CSP minimum pickup value.
4. De-initiate V_A; **OFF, EXECUTE**.

CSG UNIT PICKUP TEST

1. Connect relay terminals 20(±) and 1(N) to V_A, with V_A set to dc voltage. Monitor circuit should be connected directly across CSP normally open contacts; **VOLTAGE, 1, DC, 125, ON, EXECUTE**.

2. Refer to KA-4 relay settings on CSG and ramp dc voltage until CSG contacts close. This dc voltage value should be within ($\pm 5\%$) of rated dc voltage.
3. Record the CSG minimum pickup value.
4. De-initiate V_A ; **OFF, EXECUTE.**

SQUELCH UNIT PICKUP TEST

1. Connect relay terminals 4(\pm) and 3(N) to V_A , with V_A set to dc voltage. Monitor circuit should be connected directly across SQUELCH UNIT normally open contacts; **VOLTAGE, 1, DC, 125, ON, EXECUTE.**
2. Refer to KA-4 relay settings on SQUELCH UNIT and ramp dc voltage until SQUELCH UNIT contacts close. This dc voltage value should be within ($\pm 5\%$) of rated dc voltage.
3. Record the SQUELCH UNIT minimum pickup value.
4. De-initiate V_A ; **OFF, EXECUTE.**

ZENER DIODE TEST

1. Connect relay terminals 9(\pm) and 8(N) to I_A .
2. Set I_A equal to 200mA and initiate I_A ; **CURRENT, 1, AC, 0.2, ON, EXECUTE.**
3. Using an external voltmeter connected in parallel across relay terminal 8 and 9, the output voltage through the zener diode should not exceed 3.5 volts.
4. De-initiate I_A ; **OFF, EXECUTE.**

RECEIVER UNIT TEST

1. Refer to I.L. 41-923.4M for detailed instructions.

Testing Westinghouse Type KC Relay

AVO
Multi-Amp

PULSAR

Date: September 30, 1993 Rev: B
IEEE Device Number: 50
Function: Instantaneous Overcurrent

This relay test sheet describes the use of the AVO Multi-Amp PULSAR test instrument to perform the KC-2 and KC-4 protective relays acceptance tests. Test connections to the AVO Multi-Amp PULSAR relay test set and manufacturer recommended relay settings are included.

References:

Manufacturer's Reference
Literature

I.L.41-776.F

Test Equipment
Instructional Material

PULSAR Operating Manual

Description of Relay

The KC relay is a non-directional current or fault detector which operates for all phase and ground faults to supervise the tripping of other relays. The KC relay is well suited to breaker failure relaying for indicating the presence or loss of current flow in the circuit breaker. The KC relay could be used in a single bus/single breaker, ring bus or breaker and one-half scheme.

The KC relays consist of either one or two phase instantaneous overcurrent units, one ground instantaneous unit and an indicating contactor switch. Each instantaneous overcurrent unit consists of an induction cylinder, capacitor, varistor and a transformer. The components are connected that a contact closing torque is produced when the current exceeds the specified tap value.

PRECAUTIONS

*****WARNING*****

Dangerous and potentially fatal voltage can be developed across the output terminals of the PULSAR relay test set, refer to the PULSAR operating manual for further instructions.

Always turn the outputs **OFF** before connecting, removing or touching any output terminal or test lead, use extreme caution when turning on or using the PULSAR relay test set.

ALWAYS TEST THIS RELAY IN ITS CASE.

SETUP AND PROCEDURE

For each test:

Assign current sources as indicated in the preset conditions table.

PULSAR TEST CONDITIONS						
ASSIGN	CONNECT		TEST	VALUES		HZ
	±	N			∠	
I _A	5	4	I _A	0.5	0°	60.0
I _B	9	8	I _B	0.5	0°	60.0
I _C	7	6	I _C	0.5	0°	60.0
MON	10	1				

MINIMUM PICKUP TEST, TOP UNIT

1. Set I_A equal to tap value and initiate; **CURRENT, 1, AC, 0.5, ON, EXECUTE.**
2. Using the Ramp Arrow keys ramp current up or down to determine minimum pickup value.
3. Record the minimum pickup value.
4. De-initiate I_A; **OFF, EXECUTE.**

MINIMUM PICKUP TEST, MIDDLE UNIT

1. Set I_B equal to tap value; **CURRENT, 2, AC, 0.5, ON, EXECUTE.**
2. Using the Ramp Arrow keys ramp current up or down to determine minimum pickup value.
3. Record the minimum pickup value.
4. De-initiate I_B; **OFF, EXECUTE.**

MINIMUM PICKUP TEST, LOWER UNIT

1. Set I_C equal to tap value; **CURRENT, 3, AC, 0.5, ON, EXECUTE.**
2. Using the Ramp Arrow keys ramp current up or down to determine minimum pickup value.
3. Record the minimum pickup value.
4. De-initiate I_C; **OFF, EXECUTE.**

TIMING TEST

1. Repeat similar procedures for top unit, middle unit and bottom unit.
2. Move monitor circuit to timer stop gate.
3. Set I_A , I_B , I_C equal to fault current level(s) i. e., 2x tap and turn outputs off when relay trips; **CURRENT, 0, AC, 1.0, ON, Shift, A-OFF, ON, EXECUTE**. This command will set all 3 current channels simultaneously.
4. Initiate I_A , I_B , I_C independently using the following commands; **CURRENT, 1, ON, TIMER START, EXECUTE**. Repeat for CURRENT 2 and 3.
5. Repeat tests as necessary.
6. Reset A-OFF function; **Shift, A-OFF, OFF, EXECUTE**.

Testing Westinghouse KD Relay

AVO
Multi-Amp

PULSAR

Date: September 30, 1993 Rev: B
IEEE Device Number: 21
Function: Distance

This relay test sheet describes the use of the AVO Multi-Amp PULSAR test instrument to perform the KD-4, KD-10, KD-11 and KD-41 protective relays acceptance tests. Test connections to the AVO Multi-Amp PULSAR relay test set and manufacturer recommended relay settings are included.

References:

Manufacturer's Reference
Literature

I.L. 41-490D & 41-491.4N

Test Equipment
Instructional Material

PULSAR Operating Manual

Description of Relay

The KD relay designed by Westinghouse Electric Corporation (ABB). The KD compensator relay is designed where a polyphase four-pole cylinder relay unit is used for the 3-phase and another polyphase unit is used for the phase-to-phase unit. This allows the KD relay 3-phase unit to respond to 3-phase faults and the phase-to-phase unit to respond to phase-to-phase faults. Between these two units, one or the other unit will respond to any double-phase-to-ground fault, regardless of which pair of phases is involved.

PRECAUTIONS

*****WARNING*****

Dangerous and potentially fatal voltage can be developed across the output terminals of the PULSAR relay test set, refer to the PULSAR operation manual for further instructions.

Always turn the outputs **OFF** before connecting, removing or touching any output terminal or test lead, use extreme caution when turning on or using the PULSAR relay test set.

ALWAYS TEST THIS RELAY IN ITS CASE.

The type KD relay, is a polyphase compensator relay which provides a single zone of phase protection for all three phases.

Test Connections:

Potentials: 7,8,and 9

Currents: Jumper 12-19, 14-16-18, these jumpers will remain throughout all tests.

3-phase: potentials 7,8,9. Current in 13, out 18. Set the angles for the 3-phase MTA.

Phase-phase: A-B, 7,8,9. Current in 13, out 15.

B-C, 8,9,7. Current in 15, out 17. C-A, 9,7,8.

Current in 17, out 13. Set angles for phase-phase MTA.

Contacts: 3-phase, 10 and 20.
phase to phase, 10 and 11.

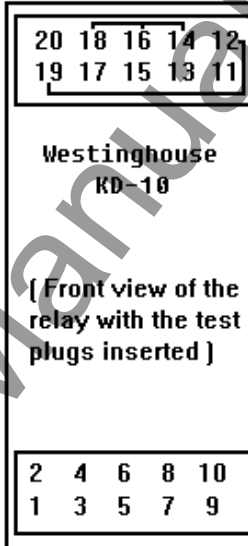

[Front view of the relay with the test plugs inserted]

CONTROL MODULE	TIMER	VOLTS	VOLTS	VOLTS
		0 0↗	0 0↗	0 0↗
AMPS		AMPS		AMPS
0 0↗		0 0↗		0 0↗

ALWAYS REFER TO THE MANUFACTURERS' LITERATURE BEFORE TESTING!

Relay Notes:

SETUP AND PROCEDURE

For each test:

Assign current and voltage sources as indicated in the preset conditions table. The test values are based upon a 75° maximum torque angle setting and open delta voltages.

KD relay settings are; T=5.8, S=1, M=0, where;

$$Z = \frac{TS}{I + M}$$

Jumper relay terminals 12 to 19 and 14 to 16 to 18. These terminals will remain jumpered throughout all testing of the KD relay.

Refer to I.L. and specific internal schematic on KD relay under test for appropriate monitoring circuit of 30 and 0 to 0 tests.

3-Phase Reach Test

PULSAR TEST CONDITIONS						
ASSIGN	CONNECT		TEST	VALUES		HZ
	±	N			∠	
V _A	7	8	V _A	30	0°	60.0
V _B	9		V _B	30	300°	60.0
I _A	13	18	I _A	5	105°	60.0
MON	*	*				

Reach Test

1. Connect monitor circuit to appropriate KD relay terminals.
2. Initiate voltage channels; **VOLTAGE, 1, AC, 30, ON, VOLTAGE, 2, AC, 30, PHASE, 300, ON, EXECUTE.**
3. Set I_A equal to a current value 0.05 amps less than the calculated value of I_F, based upon the formula;

$$I_F = \frac{V_F}{Z}$$

CURRENT, 1, PHASE, 105, AC, 5, ON, EXECUTE.

4. Using the Ramp Arrow keys ramp I_A up or down until the 30 contact operates.
5. De-initiate I_A ; **CURRENT, 1, OFF, EXECUTE.**
6. Leave voltage channels on.

Maximum Torque Angle Test

1. Set I_A equal to a current value 50% higher than the calculated value of I_F ; **CURRENT, 1, AC, 7.5, PHASE, 105, ON, EXECUTE.**
2. Using the Ramp Arrow keys ramp I_A phase angle from 105° to $\pm 30^\circ$ to find θ_1 and θ_2 until the 30 contact operates.
3. Refer to the I.L. for determining the maximum torque angle.
4. De-initiate PULSAR; **VOLTAGE, 1, 2, OFF, CURRENT, 1, OFF, EXECUTE.**

A-B Test

PULSAR TEST CONDITIONS						
ASSIGN	CONNECT		TEST	VALUES		HZ
	±	N			∠	
V_A	7	8	V_A	30	0°	60.0
V_B	9		V_B	105	278°	60.0
I_A	13	15	I_A	5	75°	60.0
MON	*	*				

Reach Test

1. Connect monitor circuit to appropriate KD relay terminals.
2. Initiate voltage channels; **VOLTAGE, 1, AC, 30, ON, VOLTAGE, 2, AC, 105, PHASE, 278, ON, EXECUTE.**
3. Set I_A equal to a current value 0.05 amps less than the calculated value of I_F , based upon the formula; $V_F = 30$ volts, the faulted phase, A-B.

$$I_F = \frac{V_F}{Z}$$

4. **CURRENT, 1, PHASE, 75, AC, 5, ON, EXECUTE.**
4. Using the Ramp Arrow keys ramp I_A up or down until the 0 - 0 contact operates.
5. De-initiate I_A ; **CURRENT, 1, OFF, EXECUTE.**
6. Leave voltage channels on.

Maximum Torque Angle Test

1. Set I_A equal to a current value 50% higher than the calculated value of I_F ; **CURRENT, 1, AC, 7.5, PHASE, 75, ON, EXECUTE.**
2. Using the Ramp Arrow keys ramp I_A phase angle from 75° to $\pm 30^\circ$ to find θ_1 and θ_2 until the 0-0 contact operates.
3. Refer to the I.L. for determining the maximum torque angle.
4. De-initiate PULSAR; **VOLTAGE, 1, 2, OFF, CURRENT, 1, OFF, EXECUTE.**

B-C Test

PULSAR TEST CONDITIONS						
ASSIGN	CONNECT		TEST	VALUES		HZ
	±	N			∠	
V_A	9	7	V_A	30	0°	60.0
V_B	8		V_B	105	278°	60.0
I_A	15	17	I_A	5	75°	60.0
MON	*	*				

Reach Test

1. Connect monitor circuit to appropriate KD relay terminals.
2. Initiate voltage channels; **VOLTAGE, 1, AC, 30, ON, VOLTAGE, 2, AC, 105, PHASE, 278, ON, EXECUTE.**
3. Set I_A equal to a current value 0.05 amps less than the calculated value of I_F , based upon the formula; $V_F = 30$ volts, the faulted phase, B-C.

$$I_F = \frac{V_F}{Z}$$

CURRENT, 1, PHASE, 75, AC, 5, ON, EXECUTE.

4. Using the Ramp Arrow keys ramp I_A up or down until the 0-0 contact operates.
5. De-initiate I_A ; **CURRENT, 1, OFF, EXECUTE.**
6. Leave voltage channels on.

Maximum Torque Angle Test

1. Set I_A equal to a current value 50% higher than the calculated value of I_F ; **CURRENT, 1, AC, 7.5, PHASE, 75, ON, EXECUTE.**
2. Using the Ramp Arrow keys ramp I_A phase angle from 75° to $\pm 30^\circ$ to find θ_1 and θ_2 until the 0-0 contact operates.
3. Refer to the I.L. for determining the maximum torque angle.
4. De-initiate PULSAR; **VOLTAGE, 1, 2, OFF, CURRENT, 1, OFF, EXECUTE.**

C-A Test

PULSAR TEST CONDITIONS						
ASSIGN	CONNECT		TEST	VALUES		HZ
	±	N			∠	
V_A	8	9	V_A	30	0°	60.0
V_B	7		V_B	105	278°	60.0
I_A	17	13	I_A	5	75°	60.0
MON	*	*				

Reach Test

1. Connect monitor circuit to appropriate KD relay terminals.
2. Initiate voltage channels; **VOLTAGE, 1, AC, 30, ON, VOLTAGE, 2, AC, 105, PHASE, 278, ON, EXECUTE.**
3. Set I_A equal to a current value 0.05 amps less than the calculated value of I_F , based upon the formula; $V_F = 30$ volts, the faulted phase, C-A.

$$I_F = \frac{V_F}{Z}$$

- CURRENT, 1, PHASE, 75, AC, 5, ON, EXECUTE.**
4. Using the Ramp Arrow keys ramp I_A up or down until the 0-0 contact operates.
 5. De-initiate I_A ; **CURRENT, 1, OFF, EXECUTE.**
 6. Leave voltage channels on.

Maximum Torque Angle Test

1. Set I_A equal to a current value 50% higher than the calculated value of I_F ; **CURRENT, 1, AC, 7.5, PHASE, 75, ON, EXECUTE.**
2. Using the Ramp Arrow keys ramp I_A phase angle from 75° to $\pm 30^\circ$ to find θ_1 and θ_2 until the 0-0 contact operates.
3. Refer to the I.L. for determining the maximum torque angle.
4. De-initiate PULSAR; **VOLTAGE, 1, 2, OFF, CURRENT, 1, OFF, EXECUTE.**

Testing General Electric Type IFCV Relay

AVO
Multi-Amp

PULSAR

Date: September 30, 1993 Rev: B
IEEE Device Number: 51
Function: Overcurrent with Voltage

Restraint

This relay test sheet describes the use of the AVO Multi-Amp PULSAR test instrument to perform the IFCV protective relay acceptance tests. Test connections to the AVO Multi-Amp PULSAR relay test set and manufacturer recommended relay settings are included.

References:

Manufacturer's Reference
Literature

GEK-49946

Test Equipment
Instructional Material

PULSAR Operating Manual

Description of Relay

The IFCV is an overcurrent relay with voltage restraint. The IFCV is primarily used as system fault backup protection at the generator or source of fault current to minimize the damage resulting from a short circuit if the primary protective devices should fail to operate.

PRECAUTIONS

*******WARNING*******

Dangerous and potentially fatal voltage can be developed across the output terminals of the PULSAR relay test set, refer to the PULSAR operation manual for further instructions.

Always turn the outputs **OFF** before connecting, removing or touching any output terminal or test lead, use extreme caution when turning on or using the PULSAR relay test set.

ALWAYS TEST THIS RELAY IN ITS CASE.

The IFCU is a single phase time over-current relay with voltage restraint.

Test Connections:

Current: 5 and 6

Potential: 7 and 8

Contacts: 1 and 2

General Electric
IFCU
[Front view of
the relay with
the test plug
inserted]

1	3	5	7	9
2	4	6	8	10

PULSAR

CONTROL MODULE	TIMER	VOLTS	VOLTS	VOLTS
		0 0↗	0 0↗	0 0↗
AMPS		AMPS		AMPS
0 0↗		0 0↗		0 0↗

ALWAYS REFER TO THE MANUFACTURERS' LITERATURE BEFORE TESTING!

Relay Notes:

SETUP AND PROCEDURE

For each test:

Assign current and voltage sources as indicated in the preset conditions table.

PULSAR TEST CONDITIONS						
ASSIGN	CONNECT		TEST	VALUES		HZ
	±	N			∠	
V _A	7	8	V _A	120	0°	60.0
I _A	5	6	I _A	2	0°	60.0
MON	1	2				

MINIMUM PICKUP TEST

1. Set V_A equal to restraint voltage and initiate V_A ; **VOLTAGE, 1, AC,120, ON, EXECUTE.**
2. Set I_A equal to tap value; **CURRENT, 1, AC, 2, ON, EXECUTE.** Note that disk should be slowly moving (creep).
3. Using the Ramp Arrow keys ramp I_A up and down to determine minimum pickup value.
4. Record the minimum pickup value.
5. De-initiate V_A and I_A; **VOLTAGE, 1, CURRENT, 1, OFF, EXECUTE.**

TIMING TEST

1. Move monitor circuit to timer stop gate.
2. Set I_A equal to fault current level(s) i.e., 2x tap, and output to turn off when relay trips; **CURRENT, 1, AC, 4 , ON, Shift, A-OFF, ON, TIMER START, EXECUTE.**
3. Upon contact closure of IFCV contacts, record the timing value.
4. Repeat tests as necessary for other multiples of tap, for example;
CURRENT, 1, AC, 6, ON, TIMER START, EXECUTE.
CURRENT, 1, AC, 8, ON, TIMER START, EXECUTE.
CURRENT, 1, AC, 10, ON, TIMER START, EXECUTE.

INSTANTANEOUS TEST

1. Move monitor circuit to terminals 1 and 3.

2. Set I_A equal to 20A ; **CURRENT, 1, AC, 20, Shift, A-OFF, ON, EXECUTE.**
3. Turn I_A ON; **CURRENT, 1, ON, EXECUTE.** Pulse I_A up or down until main trip contacts pickup, using the incremental steps of 1A and the **OFF, EXECUTE, ON, EXECUTE** sequential commands. When relay trips, output will automatically turn off.
4. Record pickup value.

Testing Westinghouse Type KLF Relay

AVO
Multi-Amp

PULSAR

Date: September 30, 1993 Rev: B
IEEE Device Number: 40
Function: Loss of Field

This relay test sheet describes the use of the AVO Multi-Amp PULSAR test instrument to perform the KLF protective relays acceptance tests. Test connections to the AVO Multi-Amp PULSAR relay test set and manufacturer recommended relay settings are included.

References:

Manufacturer's Reference
Literature

I.L. 41-748N

Test Equipment
Instructional Material

PULSAR Operating Manual

Description of Relay

The KLF relay is designed by Westinghouse Electric Corporation (ABB). The KLF is a single-phase relay connected to the ac side of asynchronous machine and contains three units connected so that the operation of two units sounds an alarm, warning of a low excitation condition. If the third unit operates the trip circuit is energized. The relay consists of two-air gaped compensators, two tapped auto transformers, one reactor, on cylinder type distance unit, directional unit with adjustable reactor, an under voltage unit with adjustable resistor, telephone relay and an indicating contactor switch.

PRECAUTIONS

*****WARNING*****

Dangerous and potentially fatal voltage can be developed across the output terminals of the PULSAR relay test set, refer to the PULSAR operation manual for further instructions.

Always turn the source output **OFF** before connecting, removing or touching any output terminal or test lead, use extreme caution when turning on or using the PULSAR relay test set.

ALWAYS TEST THIS RELAY IN ITS CASE.

The KLF relay is a single phase relay connected to the ac side of a synchronous machine and contains three units.

Directional unit - top, Distance unit - middle, Undervoltage unit - bottom.

Test Connections:

Distance & undervoltage : Potentials 4 and 5, polarity on 5.

Current: 8 and 9, polarity on 9.

Directional: Potentials 6 and 7, polarity on 6.

Currents: 8 and 9, polarity on 9.

contacts: 1 and 10, with the middle unit closed.

Potential and current pickup values should be within + or - 3%.

Undervoltage: decrease voltage until the contacts close to the left.



PULSAR

CONTROL MODULE	TIMER	VOLTS	VOLTS	VOLTS
		0 0 →	0 0 →	0 0 →
AMPS		AMPS		AMPS
0 0 →		0 0 →		0 0 →

ALWAYS REFER TO THE MANUFACTURERS' LITERATURE BEFORE TESTING!

Relay Notes:

SETUP AND PROCEDURE

For each test:

Assign current and voltage sources as indicated in the preset conditions table.

Make the following tap settings to the KLF relay:

$$T_A = 11.5 \quad T_C = 2.55$$

$$S_A = 2 \quad S_C = 1$$

$$M_A = -.03 \quad M_C = -.09$$

T_C link in middle block should be set for $+T_C$ direction. This setting corresponds to a $Z_A = 23.7\Omega$ and $Z_C = 2.80\Omega$.

Distance Unit (Z) Pick-up Test

PULSAR TEST CONDITIONS						
ASSIGN	CONNECT		TEST	VALUES		HZ
	\pm	N			Z	
V_A	5	4	V_A	80	0°	60.0
I_A	9	8	I_A	2	90°	60.0
MON	10	1				

NOTE: Block Directional Contacts closed while testing Distance Unit.

1. Set V_A for 80 volts and initiate; **VOLTAGE, 1, AC, 80, ON, EXECUTE.**
2. Set I_A for 2.0 amps and initiate; **CURRENT, 1, PHASE, 90, AC, 2, ON, EXECUTE.**
3. Using the Ramp Arrow keys and ramp the current up until the relay operates at approximately $\pm 3\%$ of 2.25 amps.
4. De-initiate PULSAR; **VOLTAGE, 1, CURRENT, 1, OFF, EXECUTE.**

PULSAR TEST CONDITIONS						
ASSIGN	CONNECT		TEST	VALUES		HZ
	±	N			∠	
V _A	5	4	V _A	80	0°	60.0
I _A	9	8	I _A	9	270°	60.0
I _B	9	8	I _B	9	270°	60.0
MON	10	1				

NOTE: DUE TO BURDEN OF RELAY, I_A and I_B must be paralleled to do test.

1. Set V_A for 80 volts and initiate; **VOLTAGE, 1, AC, 80, ON, EXECUTE.**
2. Set I_A and I_B for 9 amps and initiate; **CURRENT, 1, 2, PHASE, 270, AC, 9, ON, EXECUTE.**
3. Using the Ramp Arrow keys, ramp the current up or down until the relay operates at approximately ±3% of 19.0 amps.
4. De-initiate PULSAR; **VOLTAGE, 1, CURRENT, 1, OFF, EXECUTE.**
5. Remove blocking material from Directional Unit.

Directional Unit (D) Pick-up Test

PULSAR TEST CONDITIONS						
ASSIGN	CONNECT		TEST	VALUES		HZ
	±	N			∠	
V _A	6	7	V _A	1	0°	60.0
I _A	9	8	I _A	5	347°	60.0
MON	10	1				

NOTE: Block Distance Unit contacts closed.

1. Set V_A to 1 volt and initiate; **VOLTAGE, 1, AC, 1, ON, EXECUTE.**
2. Set I_A phase angle to 347° and initiate, where current leads the voltage by 13°; **CURRENT, 1, AC, 5, PHASE, 347, ON, EXECUTE.** The relay contacts should be closed. This is the maximum torque angle position.
3. Raise the voltage of V_A to 120 volts; **VOLTAGE, 1, AC, 120, EXECUTE.** Using the following keystrokes; **CURRENT, 1, PHASE,** and using the

Ramp Arrow keys vary the phase angle of I_A where the moving contact makes contact with the left-hand contact. These two angles (where torque reverses) should be 77° and 257° current lagging the voltage or in reference to the I.L., 283° and 103° current leading the voltage, respectively. All phase angle accuracies should be within $\pm 4^\circ$.

4. De-initiate voltage and current outputs; **VOLTAGE, 1, CURRENT, 1, OFF, EXECUTE.**
5. Remove blocking material from Distance Unit.

Undervoltage Circuit Test

PULSAR TEST CONDITIONS						
ASSIGN	CONNECT		TEST	VALUES		Hz
	\pm	N			\angle	
V_A	5	7	V_A	120	0°	60.0
MON	10	1				

NOTE: Block both Distance and Directional Unit contacts closed.

1. Set V_A for 120.0 volts; **VOLTAGE, 1, AC, 120, ON, EXECUTE.**
2. Using the Ramp Arrow keys ramp the voltage down until the relay operates at approximately ± 3 volts of 80.0 volts.
3. De-initiate PULSAR; **VOLTAGE, 1, OFF, EXECUTE.**

Telephone Relay Pick-up Test

1. Apply rated dc volts across relay terminals 10 and 3; **VOLTAGE, 1, DC, 125, ON, EXECUTE.**
2. The telephone relay (X) should open its contact.
3. Manually close the distance unit (Z) contacts and the directional unit (D) contacts, with this simultaneous simulation the telephone relay (X) contacts should close.
4. De-initiate PULSAR; **VOLTAGE, 1, DC, 0, OFF, EXECUTE.**

Testing General Electric Type PJC Relay

AVO
Multi-Amp

PULSAR

Date: September 30, 1993 Rev: A
IEEE Device Number: 51
Function: Overcurrent Relay

This relay test sheet describes the use of the AVO Multi-Amp PULSAR test instrument to perform the PJC protective relay acceptance tests. Test connections to the AVO Multi-Amp PULSAR relay test set and manufacturer recommended relay settings are included.

References:

Manufacturer's Reference
Literature

GEK-27893B

Test Equipment
Instructional Material

PULSAR Operating Manual

Description of Relay

The PJC32 relays are commonly used for instantaneous overcurrent protection of feeder circuits and for motors in conjunction with time-delay relays.

PRECAUTIONS

*******WARNING*******

Dangerous and potentially fatal voltage can be developed across the output terminals of the PULSAR relay test set, refer to the PULSAR operation manual for further instructions.

Always turn the outputs **OFF** before connecting, removing or touching any output terminal or test lead, use extreme caution when turning on or using the PULSAR relay test set.

ALWAYS TEST THIS RELAY IN ITS CASE.

The PJC32 consists of three PJC units and is commonly used for instantaneous overcurrent protection of feeder circuits and for motors in conjunction with time delay relays.

Currents: 2 and 3, 5 and 6, 8 and 9.

Contacts: 1 to 12, 7 to 15, 10 to 18.

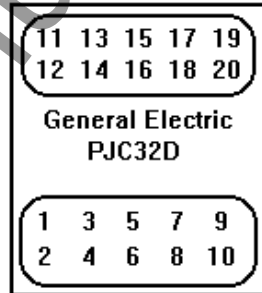

PULSAR

CONTROL MODULE	TIMER	VOLTS	VOLTS	VOLTS
		0 0↘	0 0↘	0 0↘
AMPS		AMPS		AMPS
0 0↘		0 0↘		0 0↘

ALWAYS REFER TO THE MANUFACTURERS' LITERATURE BEFORE TESTING!

Relay Notes:

SET UP AND PROCEDURE

For each test:

Assign current sources as indicated in the preset conditions table.

Execute the test as defined in the PULSAR CONDITIONS table.

PULSAR TEST CONDITIONS						
ASSIGN	CONNECT		TEST	VALUES		HZ
	±	N			∠	
I _A	2	3	I _A	*	0°	60.0
I _B	5	6	I _B	*	0°	60.0
I _C	8	9	I _C	*	0°	60.0
MON	*	*				

ALWAYS REFER TO THE MANUFACTURERS' LITERATURE BEFORE TESTING!

PICKUP TEST

1. Connect the monitor circuit to the appropriate relay contacts.
2. Set I_A to the minimum pickup value using the following keystrokes; **CURRENT, 1, AC, (*), EXECUTE.**
3. Initiate the PULSAR; **CURRENT, 1, ON, EXECUTE.** Using the appropriate Ramp Arrow keys ▲, ▼, ramp I_A to find the pickup.
4. Record the pickup value, refer to the PJC32 I.L. for any adjustment.
5. Turn I_A OFF, whenever an adjustment is required or the test is completed. **CURRENT, 1, OFF, EXECUTE.**

TIMING TEST

1. Move the monitor circuit to timer stop gate, (T2).
2. Set I_A to the pickup value, using the following keystrokes; **CURRENT, 1, AC, (*), EXECUTE.**
3. Set the output to turn OFF when the relay trips, using the following keystrokes; **Shift, A-OFF, ON, EXECUTE.**
4. Initiate I_A and start the Timer using the following keystrokes; **ON, TIMER, START, EXECUTE.**
5. Record the timing pickup value. Repeat the test if necessary

6. Reset Auto-Off, using the following keystrokes;
Shift, A-OFF, OFF, EXECUTE.

www.ElectricalPartManuals.com

Testing General Electric Type PJV Relay

AVO
Multi-Amp

PULSAR

Date: September 30, 1993 Rev: A
IEEE Device Number: 29/59
Function: Under/over voltage Relay

This relay test sheet describes the use of the AVO Multi-Amp PULSAR test instrument to perform the PJV protective relay acceptance tests. Test connections to the AVO Multi-Amp PULSAR relay test set and manufacturer recommended relay settings are included.

References:

Manufacturer's Reference
Literature

GEI-28802

Test Equipment
Instructional Material

PULSAR Operating Manual

Description of Relay

The PJV11L and PJV12B relays are single frequency AC or DC operated devices. These relays are single element high speed plunger type voltage relays.

PRECAUTIONS

*******WARNING*******

Dangerous and potentially fatal voltage can be developed across the output terminals of the PULSAR relay test set, refer to the PULSAR operation manual for further instructions.

Always turn the outputs **OFF** before connecting, removing or touching any output terminal or test lead, use extreme caution when turning on or using the PULSAR relay test set.

ALWAYS TEST THIS RELAY IN ITS CASE.

The type PJU is a plunger relay designed for general service. This relay is a non-directional and instantaneous when in operation.

Single Phase relay:

Currents: 5 and 6, polarity on 5 contacts: 1 and 2

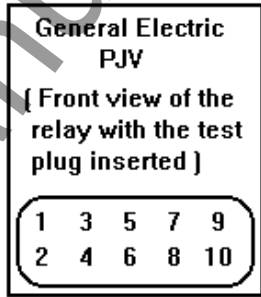

PULSAR

CONTROL MODULE	TIMER	VOLTS	VOLTS	VOLTS
		0 0↗	0 0↗	0 0↗
AMPS		AMPS		AMPS
0 0↗		0 0↗		0 0↗

ALWAYS REFER TO THE MANUFACTURERS' LITERATURE BEFORE TESTING!

Relay Notes:

SET UP AND PROCEDURE

For each test:

Assign voltage sources as indicated in the preset conditions table.

Execute the test as defined in the PULSAR CONDITIONS table.

PULSAR TEST CONDITIONS						
ASSIGN	CONNECT		TEST	VALUES		HZ
	±	N			∠	
V _A	5	6	V _A	*	0°	60.0
						60.0
MON	1	2				

ALWAYS REFER TO THE MANUFACTURERS' LITERATURE BEFORE TESTING!

NOTE: If output voltage required exceeds 300 volts, see Operating Procedures, Section 1.3, Voltage Sources - Outputs Summed Together.

PICKUP TEST

1. Connect the monitor circuit to the appropriate relay contacts.
2. Set V_A to the expected pickup value using the following keystrokes; **VOLTAGE, 1, AC, (*), EXECUTE**. NOTE: If DC relay substitute "DC" for "AC".
3. Initiate the PULSAR; **VOLTAGE, 1, ON, EXECUTE**. Using the appropriate Ramp Arrow keys ▲, ▼, ramp V_A to find the pickup.
4. Record the pickup value, refer to the PJV I.L. for any adjustment.
5. Turn V_A OFF, whenever an adjustment is required or the test is completed. **VOLTAGE, 1, OFF, EXECUTE**.

TIMING TEST

1. Move the monitor circuit to the timer stop gate, (T2).
2. Set V_A to the pickup value using the following keystrokes; **VOLTAGE, 1, AC, (*), EXECUTE**. NOTE: If DC relay, substitute "DC" for "AC".
3. Set the output to turn OFF when the relay trips using the following keystrokes; **Shift, A-OFF, ON, EXECUTE**.
4. Initiate V_A and start the Timer using the following keystrokes; **ON, TIMER, START, EXECUTE**.

5. Record the timing pickup value. Repeat the test if necessary.
6. Reset **A-OFF**, using the following keystrokes; **Shift, A-OFF, OFF, EXECUTE**.

Testing Basler Type PRS-170 Relay

AVO
Multi-Amp

PULSAR

Date: September 30, 1993 Rev: A
IEEE Device Number: 25A
Function: Auto-Synchronizing Relay

This relay test sheet describes the use of the AVO Multi-Amp PULSAR test instrument to perform the Basler Model PRS-170 Auto-Synchronizing relay acceptance tests. Test connections to the AVO Multi-Amp PULSAR relay test set and manufacturer recommended relay settings are included.

References:

Manufacturer's Reference
Literature

A90 95100 990

Test Equipment
Instructional Material

PULSAR Operating Manual

Description of Relay

The PRS-170 is a auto-synchronizing relay, with add-on modules for voltage and speed control. The synchronizer will automatically adjust generator voltage and frequency until the generator and bus are within preselected values. Then if the voltages and slip frequency are within limits, it will automatically close the breaker.

PRECAUTIONS

*******WARNING*******

Dangerous and potentially fatal voltage can be developed across the output terminals of the PULSAR relay test set, refer to the PULSAR operation manual for further instructions.

Always turn the outputs **OFF** before connecting, removing or touching any output terminal or test lead, use extreme caution when turning on or using the PULSAR relay test set.

ALWAYS TEST THIS RELAY IN ITS CASE.

The PRS-170 is an auto-synchronizing relay, with add-on modules for voltage and speed control. The synchronizer will automatically adjust generator voltage and frequency until the generator and bus are within limits, it will automatically close the breaker.

PRS-170 TERMINALS:

- 1 and 2 = 120v power source
- 3 and 4 = To Bus voltage
- 5 and 6 = To Generator voltage
- 11 and 12 = To Breaker close
- 13 and 14 = To Raise Speed
- 16 and 17 = To Lower Speed
- 19 and 20 = To Raise voltage
- 22 and 23 = To Lower voltage

PULSAR TEST CONDITIONS						
Assign	Connect		Test	Values		Hz
	+	N		ϕ	ϕ	
U_A	3	4	U_A	120°	0°	60.0
U_B	5	6	U_B	*	0°	60.0
MON	@	@				

U_A = Bus volts, U_B = Generator volts

@ = Monitor connections vary for each individual test.

* = U_B amplitudes vary depending on the test.

ALWAYS REFER TO THE MANUFACTURERS' LITERATURE BEFORE TESTING!



Relay Notes:

SETUP AND PROCEDURE

For following tests, assign voltage sources as indicated in the preset conditions table below.

PULSAR TEST CONDITIONS						
ASSIGN	CONNECT		TEST	VALUES		HZ
	±	N			∠	
V _A	3	4	V _A	120	0°	60.0
V _B	5	6	V _B	*	0°	60.0
MON	@	@				
V _A = BUS Voltage and V _B = GENERATOR Voltage						

(@) MONITOR connections vary for each individual test. See test procedure for connections. (*) V_B amplitudes vary depending on test.

NOTE: Apply AC logic voltage to relay terminals 1 and 2 for all tests.

LOW VOLTAGE PICKUP TEST (A1 OPTION ONLY)

1. Set V_A and V_B equal to rated voltage and turn on using the following keystrokes; **VOLTAGE, 1, 2, AC, 120, ON, EXECUTE**. Connect MONITOR leads to relay terminals 19 and 20.
2. Ramp V_B down using the appropriate ▼ RAMP key until the relay's LOW VOLTAGE LED lights and contacts pickup making the Timer MONITOR LED light. To ramp voltage down use the following keystrokes; **VOLTAGE, 2, AC**, and press the appropriate ▼ RAMP key.
3. Record the low voltage pickup value (adjustable between ± 0.5 to ± 4.5% difference between V_A and V_B).
4. Return V_B to rated voltage (use the ▲ RAMP key), and proceed to the next test.

NOTE: For A2 option, undervoltage control, use same procedure except pickup value is a set voltage amplitude not a % difference.

HIGH VOLTAGE PICKUP TEST (A1 OPTION ONLY)

1. If V_A and V_B are not set from previous test, set V_A and V_B equal to rated voltage and turn on using the following keystrokes; **VOLTAGE, 1, 2, AC, 120, ON, EXECUTE**. Move MONITOR leads to relay terminals 22 and 23.

2. Ramp V_B up using the appropriate ▲ RAMP key until the relay's HIGH VOLTAGE LED lights and contacts pickup making the Timer MONITOR LED light. To ramp voltage up use the following keystrokes; **VOLTAGE, 2, AC**, and press the appropriate ▲ RAMP key.
 3. Record the high voltage pickup value (adjustable between ± 0.5 to $\pm 4.5\%$ difference between V_A and V_B).
 4. Return V_B to rated voltage (use the ▼ RAMP key), and proceed to the next test.
- NOTE: For A2 option, overvoltage control, use same procedure except pickup value is a set voltage amplitude not a % difference.

LOW FREQUENCY/HIGHER SPEED TEST (F1 OPTION ONLY)

1. Set V_A and V_B equal to rated voltage and turn on using the following keystrokes; **VOLTAGE, 1, 2, AC, 120, ON, EXECUTE**. Move MONITOR leads to relay terminals 13 and 14.
2. Ramp V_B frequency down using the appropriate ▼ RAMP key until the relay's LOW FREQUENCY LED lights and contacts pickup making the Timer MONITOR LED light. To ramp frequency down use the following keystrokes; **VOLTAGE, 2, FREQ**, and press the appropriate ▼ RAMP key.
3. Record the frequency pickup value and that the control contacts closed.
4. Return V_B to system frequency (use the ▲ RAMP key), and proceed to the next test.

HIGH FREQUENCY/LOWER SPEED TEST (F1 OPTION ONLY)

1. If V_A and V_B are not set from previous test, set V_A and V_B equal to rated voltage and turn on using the following keystrokes; **VOLTAGE, 1, 2, AC, 120, ON, EXECUTE**. Move MONITOR leads to relay terminals 16 and 17.
2. Ramp V_B frequency up using the appropriate ▲ RAMP key until the relay's HIGH FREQUENCY LED lights and contacts pickup making the Timer MONITOR LED light. To ramp frequency up use the following keystrokes; **VOLTAGE, 2, FREQ**, and press the appropriate ▲ RAMP key.
3. Record the frequency pickup value and that the control contacts closed.
4. Return V_B to rated frequency (use the ▼ RAMP key), and proceed to the next test.

SLIP FREQUENCY PICKUP TEST

1. If V_A and V_B are not set from previous test, set V_A and V_B equal to rated voltage and turn on using the following keystrokes; **VOLTAGE, 1, 2, AC, 120, ON, EXECUTE**. Move MONITOR leads to the "breaker close" relay terminals 11 and 12.
2. Ramp V_B frequency up using the appropriate **▲ RAMP** key until the relay's SYNC LED lights and contacts pickup making the Timer MONITOR LED light. To ramp frequency up use the following keystrokes; **VOLTAGE, 2, FREQ**, and press the appropriate **▲ RAMP** key. Wait an appropriate time (depending on slip frequency) between increments to allow the relay time to operate. Continue slowly incrementing frequency up until the SYNC and MONITOR LED's no longer light.
3. Record the maximum slip frequency pickup value as the last slip value where the relay would close every time.
4. Return V_B to rated frequency (use the **▼ RAMP** key), and proceed to the next test.

ADVANCE TIMING TEST

1. Move monitor circuit to timer start gate, (T1).
2. Set V_A to rated voltage by using the following keystrokes; **VOLTAGE, 1, AC, 120, ON, EXECUTE**.
3. Set V_B to an appropriate output voltage and slip frequency, but do not turn on yet. For example use the following keystrokes to set a slip of 60.1 Hz; **VOLTAGE, 2, AC, 120, FREQ., 60.100, EXECUTE**. V_B DEGREES display should have dashed lines (the dashes will reset to zero's when the test is executed).
4. Set V_A and V_B to turn on and the Timer to Stop On Synchronization by using the following keystrokes, **VOLTAGE, 1, 2, Shift, TSOS, ON, EXECUTE**. V_B will turn on in phase with V_A , but will slip out of phase at the selected slip frequency. At the advance angle the relay contacts will close, thus starting the timer, when the two voltages slip into phase the Timer will stop and the outputs will turn off.
5. Read and record time. The time indicated should be the advance time setting of the relay.

Testing General Electric Type PVD

AVO
Multi-Amp

PULSAR

Date: September 30, 1993 Rev: A
IEEE Device Number: 87
Function: Transformer Differential

This relay test sheet describes the use of the AVO Multi-Amp PULSAR test instrument to perform the PVD protective relay acceptance tests. Test connections to the AVO Multi-Amp PULSAR relay test set and manufacturer recommended relay settings are included.

References:

Manufacturer's Reference
Literature

GEK-45405B

Test Equipment
Instructional Material

PULSAR Operating Manual

Description of Relay

The PVD21 relays are single phase, high speed, high impedance, voltage operated relays that are designed to provide protection in bus differential schemes when used in conjunction with suitable current transformers.

PRECAUTIONS

*******WARNING*******

Dangerous and potentially fatal voltage can be developed across the output terminals of the PULSAR relay test set, refer to the PULSAR operation manual for further instructions.

Always turn the outputs **OFF** before connecting, removing or touching any output terminal or test lead, use extreme caution when turning on or using the PULSAR relay test set.

ALWAYS TEST THIS RELAY IN ITS CASE.

The Type PUD21 relays are single phase, high speed, high impedance, voltage operated relays that are designed to provide protection in bus differential schemes when used in conjunction with suitable current transformers.

Test Connections:

87H-Overcurrent, 3 and 4 polarity on 3.
 Contact: 9 and 10.
 87L-Voltage, 5 and 6 polarity on 6.
 Contact: 1 and 2.

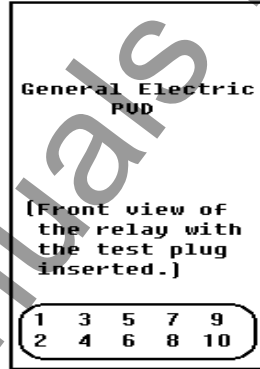

PULSAR

CONTROL MODULE	TIMER	VOLTS	VOLTS	VOLTS
		0 0↘	0 0↘	0 0↘
AMPS		AMPS		AMPS
0 0↘		0 0↘		0 0↘

ALWAYS REFER TO THE MANUFACTURERS' LITERATURE BEFORE TESTING!

Relay Notes:

SETUP AND PROCEDURE

For each test:

Assign current and voltage sources as indicated in the preset conditions table.

Execute the test as defined in the PULSAR CONDITIONS table.

PULSAR TEST CONDITIONS						
ASSIGN	CONNECT		TEST	VALUES		HZ
	±	N			∠	
V _A	6	5	V _A	*	0°	60.0
I _A	3	4	I _A	*	0°	60.0
MON	*	*				
V _A = 87L		I _A = 87H				

ALWAYS REFER TO THE MANUFACTURERS' LITERATURE BEFORE TESTING!

PICKUP TEST-87H

NOTE: If output current required exceeds 30 Amperes, see Operating Procedures, Section 1.1, Current Sources - Parallel Operation.

1. Connect the monitor circuit to the appropriate relay contacts.
2. Set I_A to the minimum pickup value using the following keystrokes;
CURRENT, 1, AC, (*), EXECUTE.
3. Initiate the PULSAR; **CURRENT, 1, ON, EXECUTE.** Using the appropriate Ramp Arrow keys, ▲, ▼, ramp I_A until the contacts pickup.
4. Record the pickup value, refer to the PVD21 I.L. for any adjustment.
5. Turn I_A OFF, whenever an adjustment is required or the test is completed.
CURRENT, 1, OFF, EXECUTE.

PICKUP TEST-87L

NOTE: If output voltage required exceeds 300 volts, see Operating Procedure, Section 1.3, Voltage Sources - Outputs Summed Together.

1. Connect the monitor to the appropriate relay contacts.
2. Set V_A to the minimum pickup value using the following keystrokes;
VOLTAGE, 1, AC, (*), EXECUTE.
3. Initiate the PULSAR; **VOLTAGE, 1, ON, EXECUTE.** Using the appropriate Ramp Arrow keys, ▲, ▼ ramp V_A until the contacts pickup.

4. Record the pickup value, refer to the PVD21 I.L. for any adjustment.
5. Turn V_A OFF, whenever an adjustment is required or the test is completed. **VOLTAGE, 1, OFF, EXECUTE.**

www.ElectricalPartManuals.com